

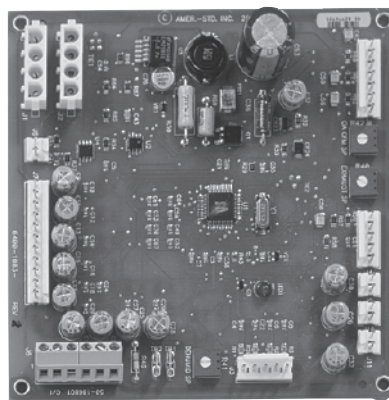

# User guide

## ReliaTel™ Microprocessor control

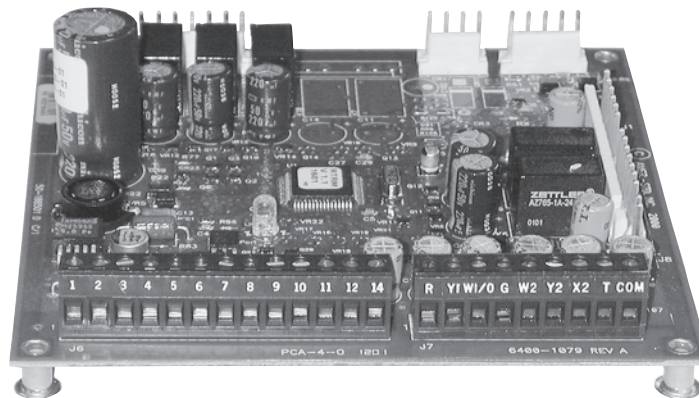



# Foreword

---

## About this manual

These instructions are given as a guide to the installation, start-up, operation and periodic maintenance by the user of the ReliaTel™ microprocessor module. They do not contain full service procedures necessary for the continued successful operation of this equipment. The services of a qualified service technician should be employed through the medium of a maintenance contract with a reputable service company. Warnings and Cautions appear at appropriate places in this instruction manual. Your personal safety and the proper operation of this machine require that you follow them carefully. Trane assumes no liability for installations or servicing performed by unqualified personnel.

## About this control module

ReliaTel™ microprocessor modules are factory run tested, before shipment.

## Warranty

Warranty is based on the general terms and conditions of the constructor. The warranty is void if the equipment is modified or repaired without the written approval of the constructor, if the operating limits are exceeded, or if the control system or the electrical wiring is modified. Damage due to misuse, lack of maintenance or failure to comply with the manufacturer's instructions or recommendations is not covered by the warranty obligation.

## Reception

On arrival, inspect the unit before signing the delivery note. Specify any damage on the delivery note, and send a registered letter of protest to the last carrier of the goods within 72 hours of delivery. Notify the local sales office at the same time. The unit should be totally inspected within 7 days of delivery. If any concealed damage is discovered, send a registered letter of protest to the carrier within 7 days of delivery and notify the local sales office.

# Contents

---

<b>Features</b>	4
<b>Control wiring</b>	5
<b>Mechanical cooling sequence of operation</b>	11
<b>Heating control (Electric heat, Modulating heat control, Hydronic Heat First)</b>	17
<b>Heat pump control (Independent defrost, Dual fuel)</b>	22
<b>Operation with a conventional thermostat</b>	23
<b>Test modes</b>	27
<b>Alarm relay</b>	34
<b>Troubleshooting</b>	35
<b>LCI-R LonTalk® Communication Interface</b>	42
<b>TCI-R Communication Interface (Comm3 / Comm4)</b>	45
<b>PIC Modbus</b>	49

*Table 1 - Abbreviations used in this manual*

AUX HT	Auxiliary Heater
BMS	Building Management System
CC	Compressor Contactor
CPR	Compressor
CSP	Cooling Setpoint
DTT	Defrost Termination Temperature
ECA	Economizer Module
EDC	Evaporator Defrost Control
EM HEAT	Emergency Heat
ESP	External Static Pressure
HSP	Heating Setpoint
ICS	Integrated Comfort System
IDM	Indoor Fan Motor
IGN	Gas Burner Module
LTB	Low Voltage Terminal Block
MAS	Mixed Air Sensor
OAE	Outdoor Air Enthalpy
OAS	Outdoor Air Sensor
OAT	Outdoor Air Temperature
OCT	Outdoor Coil Temperature
ODM	Outdoor Fan Motor
OHS	Outdoor Humidity Sensor
RAE	Return Air Enthalpy
RAT	Return Air Temperature Sensor
RHS	Return Humidity Sensor
SOV	Switch-Over Valves
UEM	Unitary Economizer Module
ZSM	Zone Sensor Module
ZTEMP	Zone Temperature Thermistor
ZTS	Zone Temperature Sensor



## Features

---

### Micro Controls

Several years ago, Trane was the first to introduce microprocessor controls into the Light Commercial Market. That design, along with immeasurable experience, has provided the technology for Trane's second-generation ReliaTel™ microprocessor controls.

### ReliaTel™ Micro Benefits

- Provides unit control for heating, cooling, and ventilating by utilizing input from sensors that measure outdoor and indoor temperature.
- Improves quality and reliability through the use of time-tested microprocessor controls and logic.
- Prevents the unit from short cycling, considerably improving compressor life.
- Ensures that the compressor will run for a specific amount of time, which allows oil to return for better lubrication, enhancing the reliability of the compressor.
- Reduces the number of components required to operate the unit, thereby reducing possibilities for component failure.
- Eliminates the need for field-installed components with its built-in anti-short-cycle timer, time delay relay and minimum "on" time controls. These controls are factory tested to assure proper operation.
- Requires no special tools to run the unit through its paces during testing. Simply place a jumper between Test 1 and Test 2 terminals on the Low Voltage Terminal Board and the unit will walk through its operational steps. The unit automatically returns control to the zone sensor after stepping through the test mode a single time, even if the jumper is left on the unit.
- As long as the unit has power and the LED is lit, the Micro is operational. The light indicates that the Micro is functioning properly.
- Features expanded diagnostic capabilities when used with Trane's Integrated Comfort™ Systems.
- As an energy benefit, softens electrical "spikes" by staging on fans, compressors and heaters.

- The Intelligent Fallback or Adaptive Control is a benefit to the building occupant. If a component goes astray, the unit will continue to operate at predetermined temperature set points.
- Intelligent Anticipation is a standard feature of the Micro. Functioning constantly, the Micro and zone sensors work together in harmony, to provide tight comfort control.

### ReliaTel™ component definitions

1. **ReliaTel™ Refrigeration Module (RTRM)** is a standard component of the unit. This is the heart of the system, the computer and program reside in this module. The typical basic stand-alone system will include the ReliaTel™ and ZSM.
2. **Zone Sensor Module (ZSM)** is an accessory component and replaces a thermostat. It provides operator interface and the zone temperature sensor for the ReliaTel™. A ZSM is required for each system.
3. **Economizer Module (ECA)** is a standard component on the economizer accessory. This module provides the hardware necessary to connect the economizer accessory to the ReliaTel™.
4. **TCI-R Communication Interface** is an accessory component. This interface module is required to connect the system to an ICS BMS (Tracer™ or Tracker™).
5. **LCI-R Communication Interface** is for connection to a Building LonTalk® Network.

# Control wiring

*Table 2 - Wire sizes and maximum wire lengths*

	Recommended wire size (mm <sup>2</sup> )	Maximum wire length (m)
<b>Zone sensor</b>		
	0.33	45
	0.5	76
	0.75	115
	1.3	185
	2	300
<b>Electromechanical Thermostat 24V AC Conductors</b>		
	0.75	000 - 140
	1.5	141 - 220

The following modules may comprise ReliaTel™. Refer to Figures 1-4 and Figure 7 for board layouts and Table 3 for LED functions.

- ReliaTel™ Refrigeration Module (RTRM)
- ReliaTel™ Options Board (RTOM)
- Economizer Actuator with Module (ECA)
- Gas Burner Module (IGN)
- TCI-R Communication Interface
- LCI-R LonTalk® Communication Interface

# Control wiring

Figure 1 - ReliaTel™ Refrigeration Module (RTRM) Layout

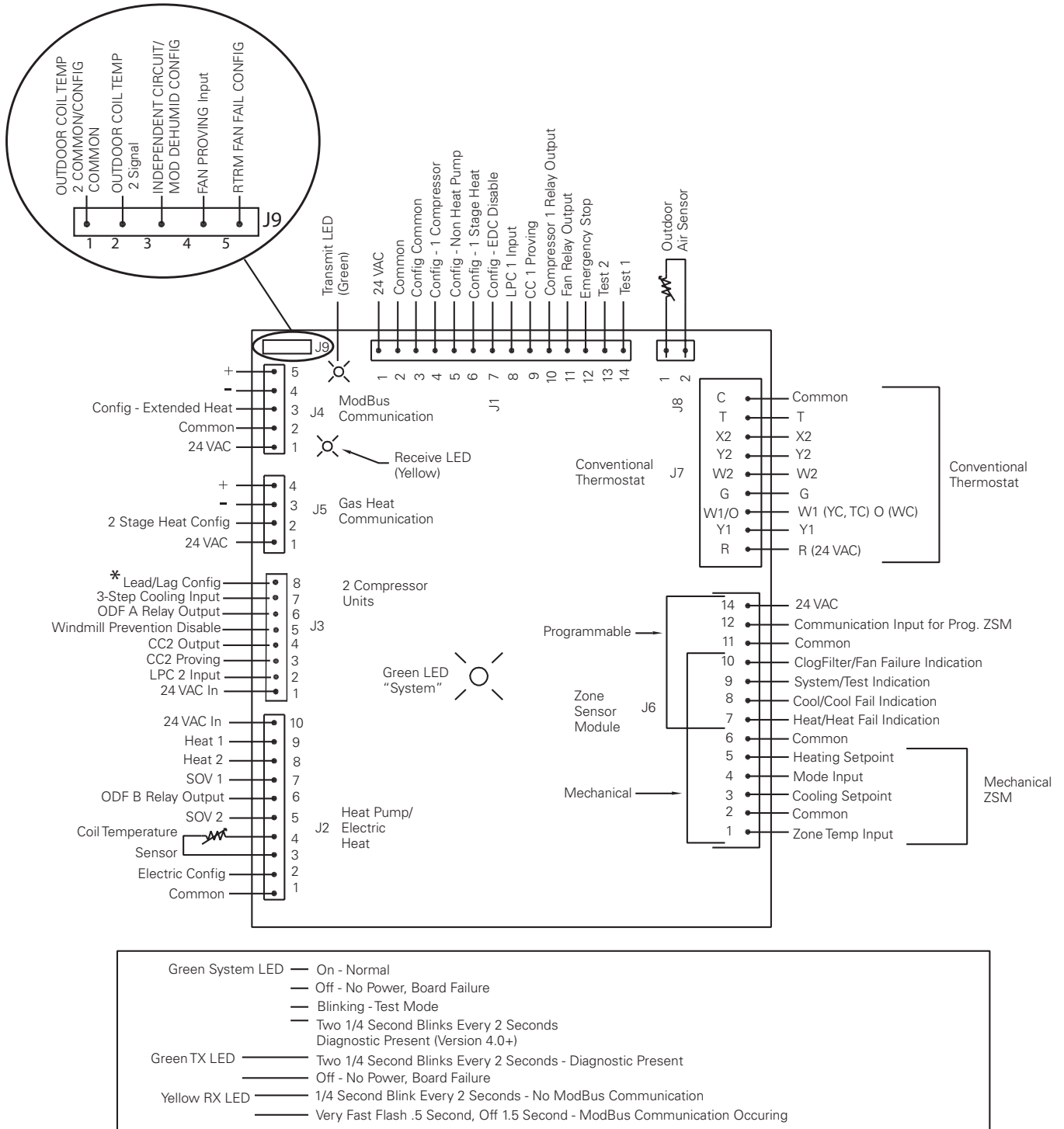

\* To enable lead/lag on multiple compressor units, cut wire connected to J-3-8

# Control wiring

Figure 2 - ReliaTel™ Options Board (RTOM) Layout

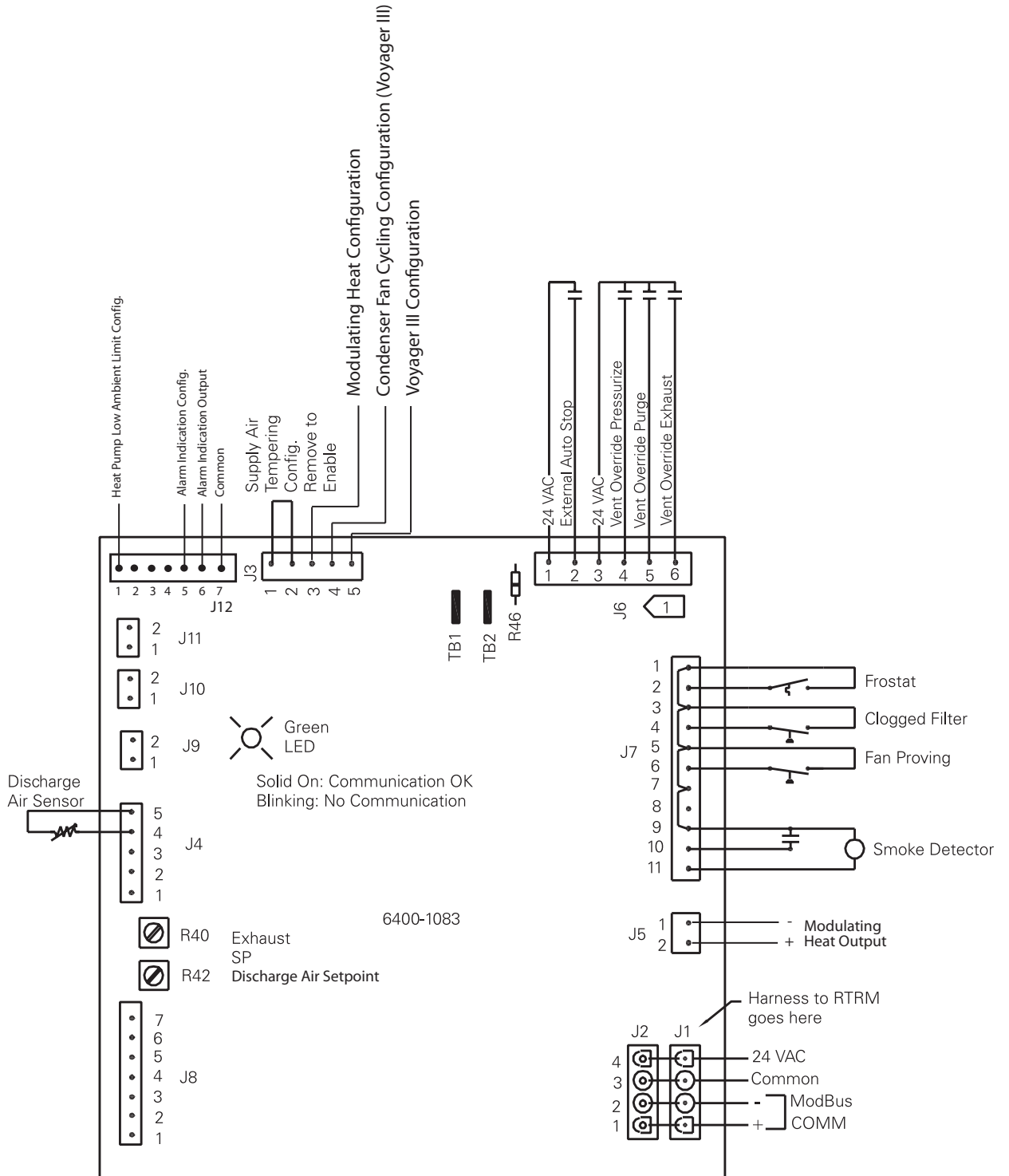

1 J6 connections shown are for current version RTOM with plug connector. See Inset A for earlier RTOM using screw terminals.

# Control wiring

Figure 3 - Economizer Actuator with module ECA-RTEM layout

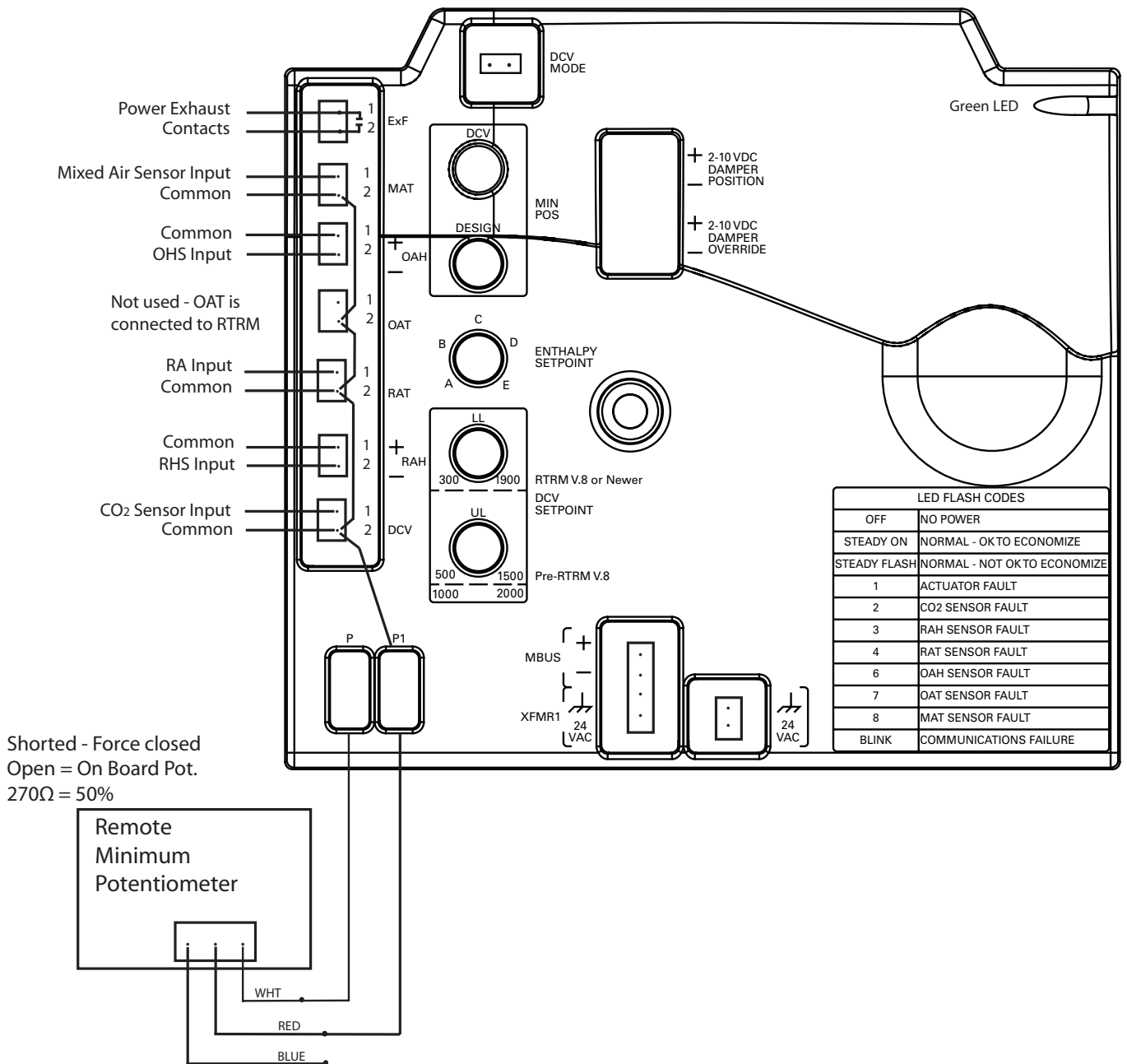



# Control wiring

Figure 4 - TCI-R/LCI-R Communication Interface Layout

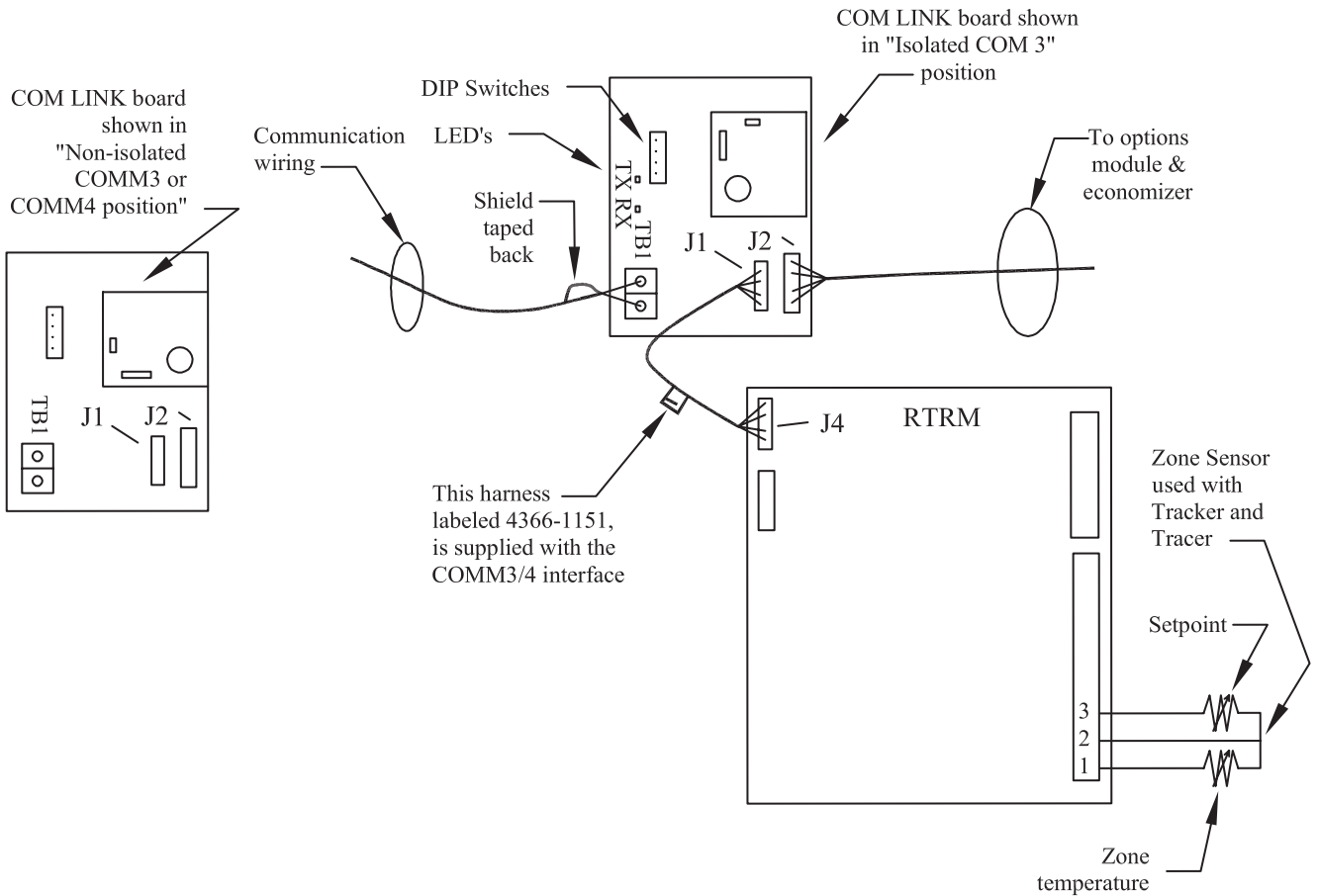

## Wiring PIC with WSD/WSH/WKD/WKH/TSD/TSH/TKD/TKH/YSD/YSH/YKD/YKH rooftop (ReliTel controller)

The following wiring diagram applies for units equipped with ReliTel controller with the TCI communication interface.

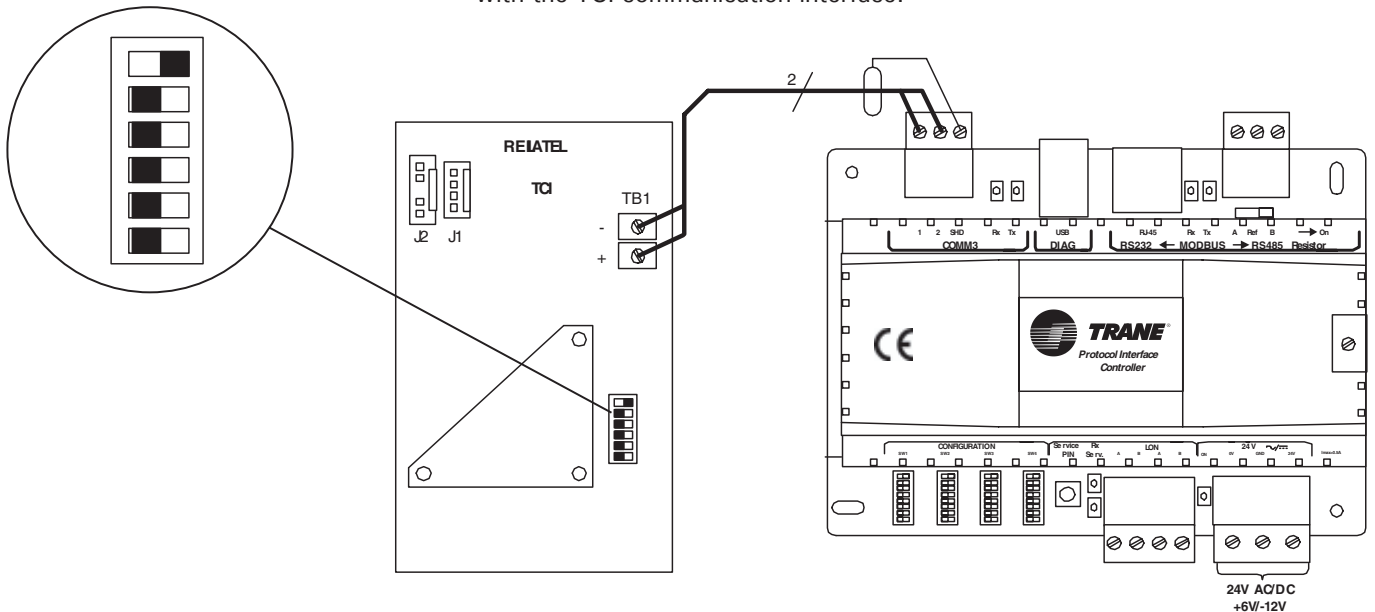



# Control wiring

Table 3 - LED Functions

<b>ReliaTel Refrigeration Module (RTRM)</b> Green System LED	<ul style="list-style-type: none"> <li>• On: Normal operation (slight flickering is normal)</li> <li>• Off: No power, board failure</li> <li>• One blink: Emergency stop open when attempting test mode.</li> <li>• 2 flashes every two seconds indicates a diagnostic is present (V 4.0 or greater) [see p.26 for a list of diagnostics]</li> <li>• Continuous ¼ second blink: Test Mode</li> </ul>
Green Transmit LED	<ul style="list-style-type: none"> <li>• Very fast flash: Normal operation, information being sent to other modules.</li> <li>• Off: System failure</li> </ul>
Yellow Receive LED	<ul style="list-style-type: none"> <li>• Very fast flash.5 second, off 1.5 second:</li> <li>• Normal communication</li> <li>• 1/4 second wink every 2 seconds:</li> <li>• Not communicating with any other module</li> <li>• Off: Board failure</li> </ul>
<b>ReliaTel Options Module (RTOM)</b> Green system LED	<ul style="list-style-type: none"> <li>• On: Normal communication with RTRM</li> <li>• 1/4 second on, 2 seconds off: No communication</li> <li>• Off: No power or board failure</li> </ul>
<b>Economizer Actuator Module (ECA-RTEM)</b> Green system LED	<ul style="list-style-type: none"> <li>• On: OK to economize</li> <li>• Slow flash: Not OK to economize</li> <li>• Fast flash: Not communicating with RTRM</li> <li>• OFF: No power or system failure</li> <li>• 1/2 second on, 2 seconds off: no communication</li> <li>• Error codes — 1/2 second on, 1/4 second off</li> <li>• 1 flash – Actuator fault</li> <li>• 2 flash – CO2 sensor</li> <li>• 3 flash – RA humidity sensor</li> <li>• 4 flash – RA temp sensor</li> <li>• 6 flash – OA humidity sensor</li> <li>• 7 flash – No Communication with RTRM or OAT sensor has failed.</li> <li>• 8 flash – MA temp sensor</li> <li>• 9-11 flash – Internal fault</li> </ul>
<b>Ignition Control (IGN)</b> <i>(See ignition control section for specific flash code schedule.)</i> Green	<ul style="list-style-type: none"> <li>• On: Normal no call for heat</li> <li>• Slow flash: Active call for heat</li> <li>• Fast flash: Not communicating with RTRM</li> <li>• Error codes</li> <li>• 2 flash – system lockout – failure to sense flame</li> <li>• 3 flash – pressure switch failure to close when CBM stops or open when CBM starts (not applicable to 12½ to 50 tons)</li> <li>• 4 flash – TCO circuit open</li> <li>• 5 flash – Flame being sensed yet gas valve not energized</li> <li>• 6 flash - Flame Rollout (FR) circuit open (Not applicable to 12½ to 50 tons)</li> </ul>
<b>TCI COMM3/4 Interface</b> Yellow receive (RX) LED	<ul style="list-style-type: none"> <li>• Flashing intermittently: ICS line activity</li> <li>• Off: Communication down or no power</li> </ul>
TCI Green transmit (TX) LED	<ul style="list-style-type: none"> <li>• Flashing intermittently: Unit is communicating OK with ICS system</li> <li>• Off yet RX light flashes – address wrong, COMM3/4 board in wrong position</li> </ul>
<b>LCI</b> LED1 Green MODBUS LED	<ul style="list-style-type: none"> <li>• Flashing intermittently: Unit is communicating to RTRM</li> </ul>
LED4 Green LCI status LED	<ul style="list-style-type: none"> <li>• Flashing intermittently: Unit is connected to a LonTalk link.</li> </ul>
LED2 Red Service LED	<ul style="list-style-type: none"> <li>• OFF: Normal</li> <li>• Flashing 1 second on, 1 second off, LCI is in unconfigured state</li> </ul>
LED3 Yellow Comm RX	<ul style="list-style-type: none"> <li>• Flashing intermittently: normal operation.</li> </ul>



# Mechanical cooling sequence of operation

Time delays are built in as described below. They increase reliability by protecting the compressor, and by maximizing efficiency of unit performance.

## Unit start-up

Each time power is applied to the system, ReliaTel™ performs internal self-diagnostic checks. It determines the system configuration (including installed options), and prepares for control of this configuration. It also checks itself for proper internal functioning. Within 1 second of start-up, the system indicator (a green light on the RTRM board) glows if programming is intact and functional. On units with the optional economizer, the damper(s) is driven open for 15-20 seconds, and then closed for approximately 90 seconds. This assures proper damper calibration.

## Cooling operation/ mechanical compressor cycle (for units without economizer)

**Note: The compressors are controlled to a minimum run time of 3 minutes, and once shut off will not start again for 3 minutes.**

On heat pump models, ReliaTel™ keeps the Switch Over Valves (SOV1 & SOV2) energized, whenever the unit is in the cooling mode.

When mechanical cooling is required, ReliaTel™ energizes the Compressor Contactor (CC1) coil. When the CC1 contacts close, the compressor CPR1 and outdoor fan motor(s) ODM1/ODM2 cycles off/on. CPR1 cycles on and off as required by cooling demands

If additional cooling is required with CPR1 running, ReliaTel™ energizes the second compressor contactor (CC2) to bring on CPR2.

**Note: A minimum of 10 seconds must have elapsed since energizing CC1.**

While CPR1 continues to run, CPR2 cycles on/off as needed to meet cooling requirements. If the indoor fan is set to «AUTO», ReliaTel™ energizes the indoor fan contactor approximately 1 second after energizing the compressor contactor. The indoor fan motor (IDM) starts when contacts close. When the cooling cycle is complete and CC1 is de-energized, the ReliaTel™ keeps the contactor energized for 60 seconds of additional IDM operation to enhance unit efficiency.

## Low ambient cooling evaporator defrost control function

The evaporator defrost control function provides standard low ambient cooling down to -18°C, at this temperature the equipment is capable of providing approximately 60% of the mechanical cooling capacity. During low ambient operation compressor run time is counted and accumulated by ReliaTel™. Low ambient operation is defined as 13°C. When accumulated compressor run time reaches approximately 10 minutes, an evaporator defrost cycle is initiated. An evaporator defrost cycle lasts approximately 3 minutes, this matches the compressor 3-minute minimum OFF time.

When an evaporator defrost cycle occurs, the compressors are turned off and the indoor fan motor continues to run. After completing an evaporator defrost cycle the unit returns to normal operation, and the compressor run time counter is reset to 0. Economizer operation is not affected by an evaporator defrost cycle.

This function can be tested, or temporarily operated in the event of an Outdoor Air Sensor (OAS) failure, by following the instructions below.

1. Electrically remove the OAS from the circuit, by cutting the wires at the splice caps in the lower right hand corner of the control box.



# Mechanical cooling sequence of operation

2. Insert a 1/4 watt resistive value in place of the OAS to simulate a low ambient condition (33K to 75K Ohms). This will simulate an outdoor air temperature between -5°C to 0°C. Place unit in cooling mode, and set cooling set point to 10°C.
3. Result = Evaporator Defrost Control (EDC) function will be activated, and compressor run time counter will begin counting and accumulating compressor run time. On dual condenser fan units, Outdoor Motor (ODM 2) will be turned «OFF» since ReliaTel™ is sensing a low ambient condition. After approximately 10 minutes, a defrost cycle will be initiated.

In the event of fan OAS failure, the resistor above may be left in the circuit to provide temporary low ambient cooling until the OAS can be replaced. If 100% mechanical cooling capacity at -18°C is required, the OAS must be permanently disconnected, and an additional low ambient control device must be selected.

## Dry bulb economizer cooling operation

An economizer consists of a fresh air damper, a return air damper, linkage to maintain an inverse relationship between the two, and an actuator to control the damper position. An economizer is used to provide two unit functions: ventilation and economizer cooling. In either case, the inverse relationship between the return and outdoor air dampers allows the unit to maintain the same approximate total airflow regardless of economizer position. A linkage adjustment is typically required in the field to adjust for differences in pressure drops due to different duct designs.

Economizer cooling is provided to take advantage of cooler outdoor air to satisfy a cooling load in a conditioned space minimizing the need for mechanical cooling (with compressors). While economizer cooling, it is necessary to limit the damper position so that the mixed air temperature does not fall below 12°C (± 1.5°C) and cause excessively cool air from being discharged from the unit. When used with a zone

sensor, an economizer setpoint that is below the cooling setpoint is used to allow sub-cooling essentially for free, further reducing the need for more expensive mechanical cooling. To maximize the use of an economizer, mechanical cooling is delayed from running until it has been determined that the economizer alone cannot satisfy the load.

Any time the supply fan is On and the building (unit) is occupied, the economizer damper will be maintained at or above minimum position. The economizer damper is held Closed when the supply fan is Off to prevent water from getting into the economizer section of the unit.

## Economizer operation:

When economizing is enabled and the unit is operating in the cooling mode with a zone sensor, the economizer damper is modulated between its minimum position and 100% to maintain the zone temperature at the economizer setpoint. When the unit is applied with a zone sensor or ICS, the economizer setpoint (ESP) is derived from the Cooling and Heating setpoints (CSP and HSP) so that ESP is the higher of 1) CSP - 1°C or 2) HSP + 1°C. When operating with a thermostat, the economizer damper will be modulated between minimum position and 100% to maintain mixed air temperature at 12°C (± 1.5°C) in response to a call for stage 1 of cooling (Y1 active), assuming economizing is enabled.

When operating with a zone sensor, compressors will be delayed for operating until the economizer has opened to 100% for 5 minutes and the zone temperature error is not being reduced quickly enough.

Different methods can be used to determine if outdoor air contains more cooling capacity than the return air. The different methods are suited for different applications and environments.



# Mechanical cooling sequence of operation

- **Comparative Enthalpy - Outdoor Air Enthalpy** is compared with Return Air Enthalpy. This method is best suited for high humidity climates and applications in which humidity can affect the cooling capacity of the outdoor air or return air.
- **Reference Dry Bulb- Outdoor Air Temperature** is compared with a user set reference temperature. This method is best suited for low humidity climates and applications in which humidity does not strongly affect cooling capacity of the outdoor air or return air.

Dry bulb temperature and relative humidity data are used to determine enthalpy. Economizer-based cooling is enabled only when outdoor air is determined to have more cooling capacity than the return air. The method used is according to the available data. When temperature and humidity data are available for the outdoor air and return air, the Comparative Enthalpy method is used. The other method is used if data is invalid or unavailable. Ultimately, when there is insufficient data to use either of the methods, economizer-based cooling is disabled.

When the Active Unit Mode is Cool, one of the methods is used to determine if economizer-based cooling should be enabled or disabled.

**Note:** If the unit is applied with a thermostat, the algorithms use a fixed mixed air temperature setpoint of 13°C when the Y1 input is closed. If the unit is applied with a zone sensor, the algorithms use a dynamically calculated mixed air temperature setpoint, which is calculated by other algorithms, when cooling is requested.

The damper can be in three different states.

**Closed:** The damper is held at 0%.

**Minimum Position:** The damper is held at the Minimum Position as determined by the Minimum Position Potentiometer on the ECA or by an edited input from ICS. This position is between 0% and 50%.

**Modulating:** Algorithms control the damper to meet cooling demand.

When modulating, the damper's range of motion is between Active Minimum Position and 100%.

The following inputs are used:

**Mixed Air Sensor (MAS)** measures the dry bulb temperature of the air leaving the evaporator coil while economizing. Return air, outdoor air and cooling caused by any compressor cooling make up the Mixed Air input. The MAS is plugged into the Economizer Actuator Module (ECA).

**Outdoor Air Sensor (OAS)** measures the ambient air surrounding the unit. It is located in the compressor section on the left side. Ventilation holes in the access panel of the unit allow air movement across the sensor. The OAS is plugged into the RTRM module.

**Outdoor Humidity Sensor (OHS)** measures the relative humidity of the outside air. It is located inside the economizer hood. The OHS is plugged into the ECA.

**Return Air Temperature Sensor (RAT)** measures the return air temperature. It is located on the return air damper of the economizer. The RAT is plugged into the ECA.

**Return Humidity Sensor (RHS)** measures the relative humidity of the return air. It is located on the return air damper of the economizer. The RHS is plugged into the ECA.



# Mechanical cooling sequence of operation

## Dry bulb/Reference Point Selections

The Dry Bulb is user-selectable, according to the choices below. This selection is made on the ECA.

*Table 4 - Dry Bulb Enthalpy Point Choices*

Potentiometer Setting Point	Dry bulb changeover Point (°C)
A	23
B	21
C	19
D	17

## Comparative Enthalpy Method

OA Enthalpy (OAE) is compared with RA Enthalpy (RAE).

- The Economizer is enabled (ENAB) when  $OA\ Enthalpy < [RA\ Enthalpy - 3.0\ BTU/lb.]$
- The Economizer is disabled (DISAB) when  $OA\ Enthalpy > RA\ Enthalpy$ .
- While  $[RA\ Enthalpy - 3.0\ BTU/lb.] < OA\ Enthalpy < RA\ Enthalpy$ , the Economizer enable/disable status is not changed.

*Figure 5 - Comparative Enthalpy Enable*

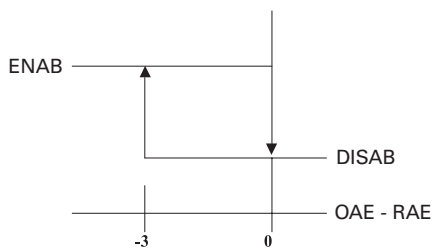

# Mechanical cooling sequence of operation

Figure 6 - Dry Bulb Enthalpy Enable

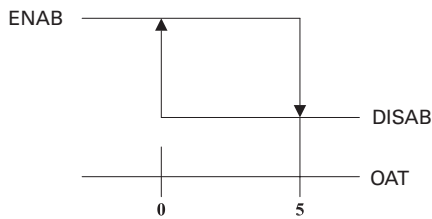

## Reference Dry Bulb Method (Figure 6)

OA Temperature (OAT) is compared with a reference dry bulb point.

- The Economizer is enabled (ENAB) when OA Temp < reference dry bulb point.
- The Economizer is disabled (DISAB) when OA Temp > (reference dry bulb point + 3.0°C).
- While reference dry bulb point < OA Temp < (reference dry bulb point + 3.0°C), the Economizer enable/disable status is not changed.

## CO2 Sensor Connections (ReliaTel Units with Demand Controlled Ventilation)

### Demand Controlled Ventilation (DCV)

Demand Controlled Ventilation (DCV) describes a control strategy that responds to the actual demand (need) for ventilation by regulating the rate at which the HVAC system brings outdoor air into the building.

DCV strategies vary the outdoor air intake in response to the current population. The practice of using carbon dioxide concentration as an indicator of population or ventilation rate is often called CO2-Based, Demand-Controlled Ventilation.

The CO2 DCV function is only available for units with economizers.

The CO2 sensor can be configured for 0-10 vdc, 0-20 ma, or 4-20 mA analog outputs. For use with the ReliaTel economizer, the sensor must be set for 0-10 vdc. As the CO2 level increases, the voltage output increases accordingly.

## RTEM Operation

Units equipped with an RTEM economizer logic module will perform Demand Controlled Ventilation differently based on the RTRM version also installed in the unit. See below for information concerning the different configurations of RTEM and RTRM versions.

### RTEM w/ RTRM v8.0 and Later

For units equipped with an RTRM v8.0 or later and also an RTEM, the control will utilize two separate Space CO2 Setpoints and two separate Damper Minimum Position Setpoints as described below:

### CO2 Setpoints

The CO2 Setpoints will be obtained through two onboard potentiometers located on the RTEM; Building Design CO2 Setpoint (Upper Limit) and DCV Minimum CO2 Setpoint (Lower Limit). The Upper Limit CO2 Setpoint will have a range of 1000-2000 ppm and the Lower Limit CO2 Setpoint will have a range of 300-1900 ppm. A 100 ppm differential will be enforced between the Upper Limit CO2 Setpoint and Lower Limit CO2 Setpoint. In the case of the Lower Limit CO2 Setpoint being set to compromise this 100 ppm differential, the Upper Limit CO2 Setpoint will not be "pushed" and the 100 ppm differential will be enforced. However, if the Upper Limit CO2 Setpoint is set to compromise the 100 ppm differential, the Lower Limit CO2 Setpoint will be pushed down in order to enforce the 100 ppm differential and to allow the Upper Limit CO2 Setpoint to be set as desired.

Table - CO2 levels and associated voltage outputs.

CO2 Level (ppm)	0	200	400	600	800	1000	1200	1400	1600	1800	2000
Voltage Output (vdc)	0	1	2	3	4	5	6	7	8	9	10

The potentiometers used for setting the CO2 setpoints and outdoor air damper position setpoints are located on the ReliaTel RTEM module.





# Mechanical cooling sequence of operation

## OA Damper Min Position Setpoints

The OA Damper Min Position setpoints will be determined by the position of two onboard potentiometers located on the RTEM; Building Design Min Position Setpoint (10-50%) and DCV Min Position Setpoint (0-40%). A 10% differential will be enforced between the Design Min Position Setpoint and DCV Min Position Setpoint; the DCV Min Position Setpoint will always be 10% less than the Design Min Position Setpoint. If the unit is configured for DCV and a Remote Min Position value is present on the P0 and P1 terminals, the Remote Min Position will become the Design Min Position Setpoint and the 10% differential will not be enforced. If the Remote Min Position is set to be lower than the DCV Min Position Setpoint, the Remote Min Position setpoint will be used for the Design Min Position and the DCV Min Position.

## Sequence of Operation

When the unit is in the occupied mode, the outdoor-air (OA) damper opens to the DCV Min Position Setpoint. If the space CO<sub>2</sub> level is less than or equal to the Lower Limit CO<sub>2</sub> Setpoint, the OA damper will close to the DCV Min Position Setpoint. If the space CO<sub>2</sub> level is greater than or equal to the Upper Limit CO<sub>2</sub> Setpoint, the OA damper will open to the Design Min Position Setpoint. If the space CO<sub>2</sub> level is greater than the Lower Limit CO<sub>2</sub> Setpoint and less than the Upper Limit CO<sub>2</sub> Setpoint, the OA damper position is modulated proportionally between the DCV Min and the Design Min Position Setpoints. If there is a call for economizer cooling, the outdoor air damper may be opened further to satisfy the cooling request. See Figure below.

### Damper position

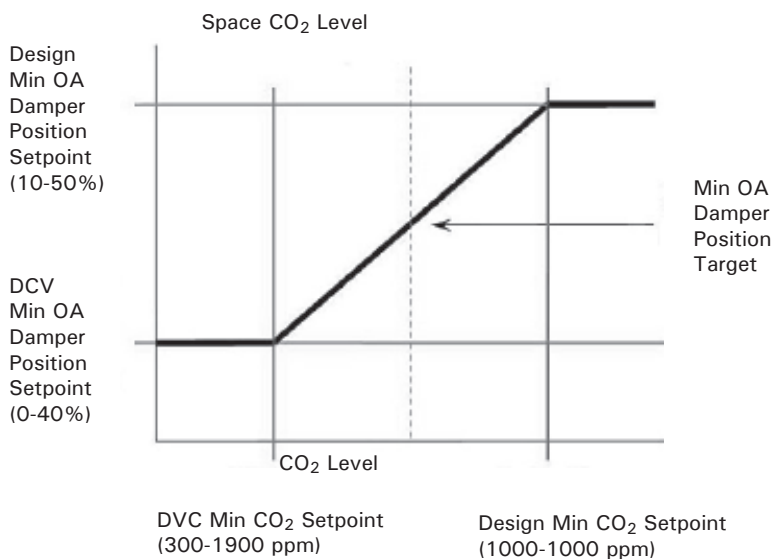

When the unit is in the unoccupied mode, DCV control is deactivated.



## Heating control

---

When heat is required, ReliaTel™ initiates first stage heating by energizing the electric heat contactor.

**Note: A minimum of 10 seconds must have elapsed since last power-up or since electric heat was last energized**

When the contacts close, the first stage electric heater bank(s) is energized, provided the element temperature limits are closed. ReliaTel™ will cycle first stage heat on and off as required to maintain zone temperature. If first stage cannot satisfy the heat requirement, ReliaTel™ energizes second stage electric heat contactor(s).

**Note: A minimum of 10 seconds must have elapsed since energizing stage one or de-energizing stage two.**

Closing of the contactor(s) energizes the second stage electric heater bank(s), provided the element temperature limits are closed. ReliaTel™ cycles second stage electric heat off/on as required to maintain zone temperature, while also keeping stage one heat energized. When the indoor fan is set to «AUTO», ReliaTel™ energizes the contactor approximately 1 second before energizing the electric heat contactor(s). The IDM starts when the contacts close. When the heating cycle is complete, ReliaTel™ de-energizes the contactor at the same time as the electric heat contactor(s).

### Mechanical and electric heat sequence of operations

When heating is required, ReliaTel™ energizes both compressors, approximately 1 second apart, and the indoor fan.

**Note: The switch-over valves are de-energized when the unit is in heat mode.**

When CC1 & CC2 contacts close, CPR1 & CPR2 start along with ODM1 & ODM2. During the heating cycle, ODM2 does not cycle on/off based on outdoor air temperature, as it does in the cooling cycle.

ReliaTel™ will cycle the mechanical heating, CPR1 & CPR2 to

maintain the zone temperature. Upon completion of the heating cycle, ReliaTel™ de-energizes the compressor contactors (CC1 & CC2). If the fan mode is in the «AUTO» position, the contactor is de-energized approximately 1 second after the compressors. Every 9 minutes after the mechanical heating cycle starts, ReliaTel™ checks the zone temperature to see if the temperature is rising sufficiently (At least 3 °C per hour). If it is not, ReliaTel™ energizes auxiliary electric heat (if installed) as needed.

**Note: ReliaTel™ has a built in 10 second delay between electric heat stages timing function. A minimum of 10 seconds must have elapsed since last power-up or since electric heat was last energized.**

If auxiliary electric heat accessory is installed, and mechanical heating cannot satisfy the demand, ReliaTel™ energizes first stage electric heat contactor(s). Their contacts close to energize the first stage electric heater banks, provided the element temperature limits are closed.

**Note: A minimum of 10 seconds must have elapsed since last power-up, or since electric heat was last de-energized.**

If mechanical heating and first stage auxiliary heat cannot satisfy the demand, ReliaTel™ energizes second stage auxiliary heat contactor(s), provided a minimum of 10 seconds have elapsed since electric heat were energized. When the electric heat contactors close, the second stage electric heater banks are energized, provided the element temperature limits are closed.

ReliaTel™ continues to check every 9 minutes, and eliminates auxiliary electric heat as soon as it determines that mechanical heat is sufficient («Smart recovery»).

# Heating control

## Discharge air setpoint adjustment (modulating heat)

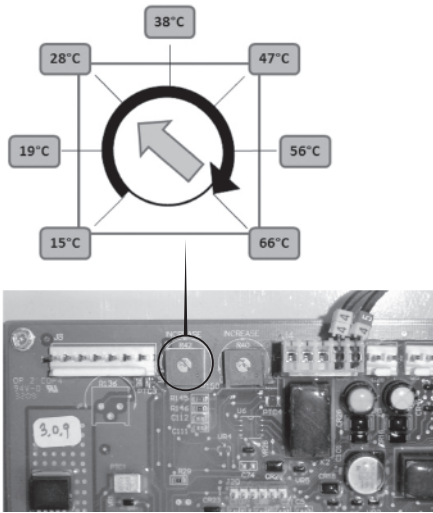

## Modulating Heat Control

The Modulating Heat Capacity Request controls the modulation level for the hydronic heat valve or the modulating gas burner input. The Heat 2 relay output is utilized to initiate the operation of the heating device. The Modulating Heat output provides a 0-10Vdc output signal for the control signal to the actuator or the gas burner module. Freezestat Protection and Freeze Avoidance are provided to prevent the hot water coils from freezing.

When activated, the modulating heat signal is controlled by the heating demand and the discharge air temperature sensors. The discharge air temperature setpoint is adjustable from the RTOM R42 potentiometer.

## Hot Water Heat First Function (Heat Pump only)

When enabled (Jumper removed from RTOM J12-3 to X40), the logic of control first starts the hot water coil prior to the mechanical heating (Heat Pump). This function is used when hot water is supplied by the heat recovery system.

## Heat Pump Demand Defrost

The first defrost cycle after power-up is initiated based on operating time at the required conditions. Shortly after completion of the defrost cycle,

the temperature difference between the outdoor coil and outdoor air is calculated and is used as an indicator of unit performance at dry coil conditions.

Over time, as moisture and frost accumulate on the coil, the coil temperature will drop, increasing the temperature difference. When the temperature difference reaches 1.8 times the dry coil temperature differential (delta T), a defrost cycle is initiated. While defrosting, the reversing valve is in the cooling position, outdoor fans are off, and the compressors continue to operate.

The defrost cycle is terminated when the coil temperature rises high enough to indicate that the frost has been eliminated. Termination of the defrost cycle includes a "soft start" delay. At the end of each defrost cycle, the outdoor fan comes on 5 seconds before the reversing valve is de-energized. This reduces stress on the compressor and makes for a quieter defrost.

There are three conditions that must be met for Demand Defrost to operate:

- Heating mode with compressor(s) operating.
- Outdoor ambient < 11°C.
- Outdoor coil < 0.5°C on any circuit.

Typical Demand Defrost Cycle

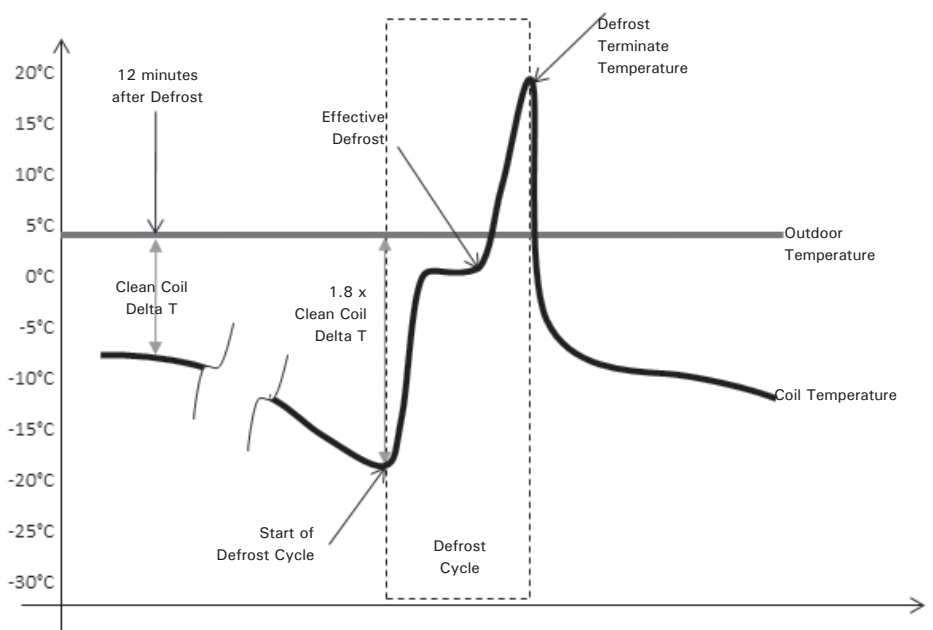



# Heating control

---

## Defrost Service Test

When a Service Test Defrost Request is received, defrost mode is initiated immediately. The defrost cycle will remain active for a minimum of 1 minute, after which the normal termination will occur when the coil temperature exceeds the defrost termination temperature as defined below. The Service Test Defrost Request will remain active for a maximum of 10 minutes, after which the unit will transition out of the defrost step as described below.

## Defrost Mode Operation

Defrost Mode shall remain active until the Outdoor Coil Temperature (OCT) exceeds the Defrost Termination Temperature (DTT) or until ten (10) minutes have passed, whichever occurs first. If all Compressor Outputs turn Off during the defrost cycle, such as during a High Pressure Cutout, Defrost Mode will terminate.

When Defrost Mode has terminated, the function will track twelve (12) minutes to assure that a dry coil condition has been achieved. At the twelve-minute point, DT will be calculated using the current values of OAT and OCT (OAT is expected to be higher than OCT). This value is multiplied by 1.8 to calculate the new Initiate Value. The above figure presents a graphical representation of a typical demand defrost cycle.

## Sequence of Operation

Demand defrost is standard feature which permits defrost whenever coil icing conditions begin to significantly reduce unit capacity. To permit defrost, the outdoor temperature must be below 11°C, coil temperature must be below 0.5°C, and the delta temperature F must exceed a RTRM calculated value. After 30 minutes of run time under defrost permit conditions, the RTRM initiates a defrost cycle. Upon termination of this cycle, the RTRM monitors the outdoor temperature (ODT) and the coil temperature (CT) and calculates the delta temperature F (ODT-CT). This value is stored in memory and the RTRM calculates a defrost initiate value. The RTRM continually compares the delta temperature F to the defrost initiate value. Once the delta T reaches the initiate value, a defrost cycle is initiated. During the defrost cycle, the RTRM energizes the relay (K3), which energizes the switch over valve (SOV) through the normally open K3 relay contact. This will then turn the outdoor fan motor(s) (ODM) 'Off' by de-energizing the (K8) and (K7) relays, which de-energizes the (ODF) relays. The RTRM energizes the auxiliary electric heat contactor (AH), and (BH) (if applicable), if they are not operating, while maintaining compressor (CPR1) operation. The defrost cycle is terminated based on the RTRM termination temperature calculation using the outdoor temperature (ODT) 26°C. The defrost termination temperature (DTT) will be limited between 14°C and 22°C.



# Heating control

## Emergency Heat Operation

When the system selection switch is in the 'EM HEAT' Mode, and the zone temperature falls below the heating setpoint controlband, the RTRM bypasses compressor and outdoor fan operation and energizes the K1 relay located on the RTRM. When K1 relay contacts close, the first stage auxiliary electric heat contactor (AH) is energized. If the first stage of auxiliary electric heat cannot satisfy the heating requirement, the RTRM energizes the K2 relay located on the RTRM.

## Diagnostic Information

Demand Defrost also tracks failures and operating problems as follows:

When the K2 relay contacts close, the second stage auxiliary electric heat contactor (BH) is energized. The RTRM cycles both the first and second stages of heat 'On' and 'Off' as required to maintain the zone temperature setpoint.

Correct defrost operation relies on accurate temperature information from the outside air sensor (OAS) and the coil temperature sensors (CTS).

If either of these sensors fail, the unit will revert to the default mode any time the unit is in the active heat mode with compressors running.

When any Defrost Fault is active, or if any sensor has failed, a 5-minute defrost cycle will be initiated after each 30 minutes of cumulative compressor heating operation.

Table 5 - Demand Defrost fault designation

Symptom	Diagnostic	Response
Coil temperature Sensor Failure	Sensor is shorted or open	Activate Defrost Fault
Outdoor Temperature Sensor Failure	Sensor is shorted or open	Activate Defrost Fault
DT is below Minimum Value 12 minutes after defrost is terminated	Low DT	If > 2 hours, activate Defrost Fault Reset timer if DT returns within bounds
Defrost Terminated on time requirement	Time Termination	If defrost is terminated on time requirement (vs. differential temperature) After 10 consecutive Time Terminations, activate Defrost Fault.
DT is above Maximum Value 12 minutes after defrost is terminated	High DT	Initiate Defrost After 16 consecutive High DT Initiations activate Defrost Fault.
DT does not change by 1 degree in an hour's time starting 12 minutes after defrost is terminated and DT is less than or equal to 2 degrees 12 minutes after defrost is terminated	Unchanging DT	Initiate Defrost and activate Defrost Activate Defrost Fault

Defrost Termination Temperature (DTT) = Outdoor Air Temperature (OAT) + 26°C  
 14°C ≤ DDT ≤ 22°C

DT = Outdoor Air Temperature (OAT) – Outdoor Coil Temperature (OCT) Defrost Initiate Temperature = 1.8 \* (DT) 12 Minutes After Defrost Mode is terminated)



# Heat pump control

---

## Independent Circuit Defrost Operation

For Independent Circuit Heat Pump units with two outdoor coil temperature sensors, the unit will perform defrost per circuit based on its own coil temperature sensor value, the outdoor ambient temperature, and the accumulated circuit run time. At least one stage of auxiliary heat will be energized anytime either circuit is in defrost mode. All other defrost functionality, including the diagnostic conditions, will perform as described above independently per circuit.

## Dual Fuel

Dual fuel is a heat pump unit with an integrated gas burner as auxiliary heat.

The first stage is mechanical heating (Heat pump). The gas burner replaces mechanical heating if the zone temperature rises too slowly (3.3°C/ Hour).

Mechanical heating can be disabled by disconnecting the 24V input J1-8 and J3-2. This makes the unit run in gas burner mode only.



## Operation with a Conventional Thermostat

The ReliaTel module has conventional thermostat connections as well as Zone Sensor Module connections. When a conventional thermostat is controlling the unit, operation differs as follows:

The terminal strip for attaching the thermostat wires is located on the RTRM module in the control compartment. The purpose of each terminal is discussed in the next section.

- Supply Air Tempering feature is not available. If outdoor air is being introduced through the equipment, discharge air temperature may be cold when not actively heating.
- Proportional Integral (PI) control is not available.
- Intelligent Fall-Back is not available. If a failure occurs in the device controlling the equipment, operation will cease.
- Heat Pump Smart Recovery and Smart Staging is not available. Heat Pump operation becomes more costly unless the generic control being applied can accomplish this.
- Built in Night Set Back and Unoccupied Functions function differently with a conventional mechanical thermostat.
- A built-in algorithm which allows for automatic reset of the discharge air temperature while economizing is not available.

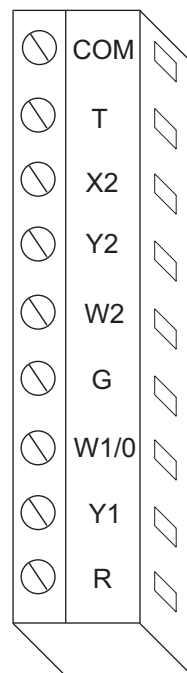



## Operation with a Conventional Thermostat

---

Conventional thermostat signals represent direct calls for unit functions. In their simplest applications, thermostat contacts directly control contactors or other load switching devices. This function provides inputs for the thermostat signals and processing to enhance reliability and performance. Compressor protection and reliability enhancement functions (HPC, LPC, Minimum On/Off timers, etc.). All operate the same whether applied with zone sensors or a conventional thermostat. Logic is also provided to cause appropriate unit functions when inappropriate thermostat signals are provided. Simultaneous calls for heating and cooling will be ignored, and the fan will be turned on with a call for heating or cooling even if the fan request is not detected.

If the thermostat is immediately changed from a heating to a cooling call, or vice versa, there will be a five minute delay before the new call will initiate.



# Operation with a Conventional Thermostat

---

## Conventional thermostat - Gas/ Electric, Electric Heat

Input/connection	Function when energized
G (fan)	Fan runs continuously except during unoccupied mode (see next page)
Y1 (compressor 1 or economizer) operates	Compressor #1 runs or economizer
Y2 (compressor 2 or compressor 1 while economizing)	Compressor #2 also runs, or #1 compressor runs while economizing
W1 (gas / electric heat first stage)	1 <sup>st</sup> stage heat
W2 (gas / electric heat 2 <sup>nd</sup> stage)	2 <sup>nd</sup> stage heat (if available)

## Conventional thermostat - Heat Pump

Input/connection	Function when energized
<b>Cooling mode :</b>	
G (fan)	Fan runs continuously except during unoccupied mode (see next page)
O (reversing valve during cooling)	Reversing valve in cool mode
Y1 + O (first stage cooling)	Compressor #1 runs or economizer
Y1 + Y2 + O (2 <sup>nd</sup> stage cool) compressor runs while economizing.	Compressor #2 also runs, or #1
<b>Heating mode:</b>	
G (fan)	Fan runs continuously except during unoccupied mode (see below)
Y1 (both compressors 1 <sup>st</sup> stage heat)	Both compressors run
Y2 (during heating - nothing happens)	No change
W2 (electric heat 2 <sup>nd</sup> stage)	2 <sup>nd</sup> stage (electric) heat
X2 (electric heat only)	Electric heat only - no compressors
T (provides heat anticipation signal for those mechanical thermostats that use this feature. If the thermostat used does not have a «T» terminal, disregard this terminal.	





# Operation with a Conventional Thermostat

Unoccupied mode: If the thermostat being used is programmable, it will have its own strategy for unoccupied mode and will control the unit directly. If a mechanical thermostat is being used, a field applied time clock with relay contacts connected to J611 and J6-12 can initiate an unoccupied mode as follows:

Contacts open:  
Normal occupied operation.

Contacts closed:  
Unoccupied operation as follows - Fan in auto mode regardless of fan switch position.

Economizer closes except while economizing regardless of minimum position setting.

## Cooling/Economizer Operation

If unit does not have an economizer, the Cool/Econ Stage 1 and Stage 2 will call directly for mechanical cooling (compressor) stages. If the unit has an economizer, the Cool/Econ stages will function as follows.

OK to Economize?	Thermostat Y1	Call for Thermostat Y2	Economizer Cooling	Compressor Staging Request
No	On	Off	Inactive	Compressor Output 1
No	Off	On	Inactive	Compressor Output 2
No	On	On	Inactive	Compressor Outputs 1 & 2
Yes	On	Off	Active	Off
Yes	Off	On	Active	Off
Yes	On	On	Active	Compressor Output 1

Notes:

TK/YK #400-600

This unit has 3 stages of cooling if using a zone sensor or binary inputs as shown above.

If using a conventional thermostat it has 2 stages as follows:

Y1	=	1 <sup>st</sup> stage
Y1+Y2	=	3 <sup>rd</sup> stage



# Test modes

There are 2 methods in which the «Test» mode can be cycled at LTB-Test 1 and LTB-Test 2.

## 1. Step Test Mode

This method initiates the different components of the unit, one at a time, by temporarily shorting across the two test terminals for two to three seconds. For the initial start-up of the unit, this method allows the technician to cycle a component «On» and have up to 1 hour to complete the check.

## 2. Auto Test Mode

This method is not recommended for start-up due to the short timing between individual component steps. This method initiates the different components of the unit, one at a time, when a jumper is installed across the test terminals. The unit will start the first test step and change to the next step every 30 seconds. At the end of the test mode, control of the unit will automatically revert to the applied «System» control method.

For unit test steps and test modes, values to cycle the various components, refer to Tables 6-15.

Table 6 - Cooling only units single compressor

		Outputs						Voyager 1	
Mode		Comp.1	CDS Fan 1	Heat 1	Heat 2	Econo. <sup>2</sup>	Supply Fan	060-090	
1.	Fan ON	Off	Off	Off	Off	Min.	On	X	
2.	Econo.	Off	Off	Off	Off	100%	On	X	
3.	Cool 1	On	Norm. <sup>1</sup>	Off	Off	Min.	On	X	
4.	Heat 1	Off	Off	On	Off	Min.	On	X	
5.	Heat 2	Off	Off	On	On	Min.	On	X	

Table 7 - Cooling only unit double compressor

		Outputs								Voyager 1		Voyager 2		Voyager 3	
Mode		Comp.1	Comp.2	CDS Fan 1	CDS Fan 2	Heat 1	Heat 2	Econo. <sup>2</sup>	Supply Fan	102-120	125-265	290-340	275-350	400-600	
1.	Fan On	Off	Off	Off	Off	Off	Off	Min.	On	X	X	X	X	X	
2.	Econo.	Off	Off	Off	Off	Off	Off	100%	On	X	X	X	X	X	
3.	Cool 1	On	Off	Norm. <sup>1</sup>	Norm. <sup>1</sup>	Off	Off	Min.	On	X	X	X	X	X	
4.	Cool 2	On	On	Norm. <sup>1</sup>	Norm. <sup>1</sup>	Off	Off	Min.	On	X	X	X	X	X	
5.	Cool 3 <sup>4</sup>	On	On	Norm. <sup>1</sup>	Norm. <sup>1</sup>	Off	Off	Min.	On					X	
6.	Heat 1	Off	Off	Off	Off	On	Off	Min.	On	X	X	X	X	X	
7.	Heat 2	Off	Off	Off	Off	On	On	Min.	On	X	X	X	X	X	

Standard  
Option

# Test modes

**Table 8 - Cooling only unit with modulating heat**

Mode	Outputs									Voyager 2		Voyager 3	
	Comp.1	Comp.2	CDS Fan 1	CDS Fan 2	Heat 1	Heat 2	Modulating Heat	Econo. <sup>2</sup>	Supply Fan	125-265	290-340	275-350	400-600
1. Fan On	Off	Off	Off	Off	Off	Off	Off	Min.	On	X	X	X	X
2. Econo.	Off	Off	Off	Off	Off	Off	Off	100%	On	X	X	X	X
3. Cool 1	On	Off	Norm. <sup>1</sup>	Norm. <sup>1</sup>	Off	Off	Off	Min.	On	X	X	X	X
4. Cool 2	On <sup>3</sup>	On	Norm. <sup>1</sup>	Norm. <sup>1</sup>	Off	Off	Off	Min.	On	X	X	X	X
5. Cool 3 <sup>4</sup>	On	On	Norm. <sup>1</sup>	Norm. <sup>1</sup>	Off	Off	Off	Min.	On				X
6. Heat 1	Off	Off	Off	Off	Off	On	50%	Min.	On	X	X	X	X
7. Heat 2	Off	Off	Off	Off	Off	On	100%	Min.	On	X	X	X	X

**Table 9 - Reversible unit single compressor**

Mode	Outputs								Voyager 1	
	Comp.1	CDS Fan 1	Heat 1	Heat 2	SOV 1	Econo. <sup>2</sup>	Supply Fan	060-090		
1. Fan On	Off	Off	Off	Off	Off	Min.	On	X		
2. Econo.	Off	Off	Off	Off	On	100%	On	X		
3. Cool 1	On	Norm. <sup>1</sup>	Off	Off	On	Min.	On	X		
4. Heat 1	On	On	Off	Off	Off	Min.	On	X		
5. Heat 2	On	On	On	Off	Off	Min.	On	X		
6. Heat 3	On	On	On	On	Off	Min.	On	X		
7. Defrost	On	Off	On	Off	On	Min.	On	X		
8. Em Heat	Off	Off	On	On	Off	Min.	On	X		

**Table 10 - Reversible unit double compressor (1 condenser air flow section)**

Mode	Outputs									Voyager 2	
	Comp.1	Comp.2	CDS Fan 1	CDS Fan 2	Heat 1	Heat 2	SOV 1	Econo. <sup>2</sup>	Supply Fan	125-265	
1. Fan On	Off	Off	Off	Off	Off	Off	Off	Min.	On	X	
2. Econo.	Off	Off	Off	Off	Off	Off	On	100%	On	X	
3. Cool 1	On	Off	Norm. <sup>1</sup>	Norm. <sup>1</sup>	Off	Off	On	Min.	On	X	
4. Cool 2	On	On	Norm. <sup>1</sup>	Norm. <sup>1</sup>	Off	Off	On	Min.	On	X	
5. Heat 1	On	On	On	On	Off	Off	Off	Min.	On	X	
6. Heat 2	On <sup>5</sup>	On <sup>5</sup>	On <sup>5</sup>	On <sup>5</sup>	On	Off	Off	Min.	On	X	
7. Heat 3	On <sup>5</sup>	On <sup>5</sup>	On <sup>5</sup>	On <sup>5</sup>	On	On	Off	Min.	On	X	
8. Defrost	On	On	Off	Off	On	Off	On	Min.	On	X	
9. Em Heat	Off	Off	Off	Off	On	On	Off	Min.	On	X	

Standard

Option



# Test modes

Table 11 - Reversible unit double compressor (2 condenser air flow section)

Mode	Outputs										Voyager 2	
	Comp.1	Comp.2	CDS Fan 1	CDS Fan 2	Heat 1	Heat 2	SOV 1	SOV 2	Econo. <sup>2</sup>	Supply Fan	290-340	400-600
1. Fan On	Off	Off	Off	Off	Off	Off	Off	Off	Min.	On	X	X
2. Econo.	Off	Off	Off	Off	Off	Off	On	On	100%	On	X	X
3. Cool 1	On	Off	Norm. <sup>1</sup>	Off	Off	Off	On	On <sup>6</sup>	Min.	On	X	X
4. Cool 2	On	On	Norm. <sup>1</sup>	Norm. <sup>1</sup>	Off	Off	On	On <sup>6</sup>	Min.	On	X	X
5. Heat 1	On	Off	On	Off	Off	Off	Off	Off	Min.	On	X	X
6. Heat 2	On	On	On	On	Off	Off	Off	Off	Off	On		
7. Heat 3	On <sup>5</sup>	On <sup>5</sup>	On <sup>5</sup>	On <sup>5</sup>	On	Off	Off	Off	Min.	On	X	X
8. Heat 4	On <sup>5</sup>	On <sup>5</sup>	On <sup>5</sup>	On <sup>5</sup>	On	On	Off	Off	Min.	On	X	X
9. Defrost	On	On	Off	Off	On	Off	On	On <sup>6</sup>	Min.	On	X	X
10. Em Heat	Off	Off	Off	Off	On	On	Off	Off	Min.	On	X	X

Caution: at steps 3 and 4, a fan per circuit can run independently from the CDS Fan 1 and 2 outputs (one fan is directly linked to the compressor).

Table 12 - Reversible unit double compressor (1 condenser air flow section) + Modulating Heat First

Mode	Outputs										Voyager 2
	Comp.1	Comp.2	CDS Fan 1	CDS Fan 2	Heat 1	Heat 2	Modulating Heat	SOV 1	Econo. <sup>2</sup>	Supply Fan	125-265
1. Fan On	Off	Off	Off	Off	Off	Off	Off	Off	Min.	On	X
2. Econo.	Off	Off	Off	Off	Off	Off	Off	On	100%	On	X
3. Cool 1	On	Off	Norm. <sup>1</sup>	Norm. <sup>1</sup>	Off	Off	Off	On	Min.	On	X
4. Cool 2	On	On	Norm. <sup>1</sup>	Norm. <sup>1</sup>	Off	Off	Off	On	Min.	On	X
5. Heat 1	Off	Off	Off	Off	Off	On	50%	Off	Min.	On	X
6. Heat 2	Off	Off	Off	Off	Off	On	100%	Off	Min.	On	X
7. Heat 3	On <sup>5</sup>	Off	On	Off	Off	On	100%	Off	Min.	On	X
8. Heat 4	On <sup>5</sup>	On <sup>5</sup>	On	On	Off	On	100%	Off	Min.	On	X
9. Defrost	On	On	Off	Off	Off	On	100%	On	Min.	On	X
10. Em Heat	Off	Off	Off	Off	Off	On	100%	Off	Min.	On	X

Standard  
Option



# Test modes

Table 13 – Reversible unit double compressor (2 condenser air flow section or Smart Defrost) + Modulating Heat First

Mode	Outputs											Voyager 2		
	Comp.1	Comp.2	CDS Fan 1	CDS Fan 2	Heat 1	Heat 2	Modulating Heat	SOV 1	SOV 2	Econo. <sup>2</sup>	Supply Fan	290-340	400-600	
1. Fan On	Off	Off	Off	Off	Off	Off	Off	Off	Off	Off	Min.	On	X	X
2. Econo.	Off	Off	Off	Off	Off	Off	Off	On	On	100%	On	X	X	
3. Cool 1	On	Off	Norm. <sup>1</sup>	Off	Off	Off	Off	On	On <sup>6</sup>	Min.	On	X	X	
4. Cool 2	On	On	Norm. <sup>1</sup>	Norm. <sup>1</sup>	Off	Off	Off	On	On <sup>6</sup>	Min.	On	X	X	
5. Heat 1	Off	Off	Off	Off	Off	On	50%	Off	Off	Min.	On	X	X	
6. Heat 2	Off	Off	Off	Off	Off	On	100%	Off	Off	Min.	On	X	X	
7. Heat 3	On	Off	On	Off	Off	On	100%	Off	Off	Min.	On	X	X	
8. Heat 4	On	On	On	On	Off	On	100%	Off	Off	Min.	On	X	X	
9. Defrost	On	On	Off	Off	Off	On	100%	On	On <sup>6</sup>	Min.	On	X	X	
10. Em Heat	Off	Off	Off	Off	Off	On	100%	Off	Off	Min.	On	X	X	

Table 14 - Reversible unit double compressor with modulating heat

Mode	Outputs											Voyager 2		Voyager 3	
	Comp.1	Comp.2	CDS Fan 1	CDS Fan 2	Heat 1	Heat 2	Modulating Heat	SOV 1	SOV 2	Econo. <sup>2</sup>	Supply Fan	125-265	290-340	400-600	
1. Fan On	Off	Off	Off	Off	Off	Off	Off	Off	Off	Off	Min.	On	X	X	X
2. Econo.	Off	Off	Off	Off	Off	Off	Off	Off	Off	Off	100%	On	X	X	X
3. Cool 1	On	Off	Norm. <sup>1</sup>	Norm. <sup>1</sup>	Off	Off	Off	On	On <sup>6</sup>	Min.	On	X	X	X	
3. Cool 2	On	On	Norm. <sup>1</sup>	Norm. <sup>1</sup>	Off	Off	Off	On	On <sup>6</sup>	Min.	On	X	X	X	
4. Heat 1	On	Off	On	On	Off	Off	Off	Off	Off	Min.	On	X	X	X	
5. Heat 2	On	On	On	On	Off	Off	Off	Off	Off	Min.	On	X	X	X	
6. Heat 3	On <sup>5</sup>	On <sup>5</sup>	On <sup>5</sup>	On <sup>5</sup>	Off	On	50%	Off	Off	Min.	On	X	X	X	
6. Heat 4	On <sup>5</sup>	On <sup>5</sup>	On <sup>5</sup>	On <sup>5</sup>	Off	On	100%	Off	Off	Min.	On	X	X	X	
7. Defrost	On	On	Off	Off	Off	On	50%	On	On <sup>6</sup>	Min.	On	X	X	X	
8. Em Heat	Off	Off	Off	Off	Off	On	100%	Off	Off	Min.	On	X	X	X	

Standard

Option

Table 15 - For units with gas burner

	Unit with 1 gas burner	Unit with 2 gas burners	Unit with 1 modulating gas burner
Heat 1	Burner 1 : low speed	Burner 1 : high speed Burner 2 : OFF	50%
Heat 2	Burner 1 : high speed	Burner 1 : high speed Burner 2 : high speed	100%

# Test modes

## Alternate test mode procedures

### Zone Sensor Module (ZSM) service indicator

The ZSM SERVICE LED is a generic indicator that will signal the closing of a normally open switch at any time, providing the indoor motor is operating. This indicator is usually used to indicate a clogged filter, or an airside fan failure.

ReliaTel™ will ignore the closing of this normally open switch for 2 (+/-1) minutes. This helps prevent nuisance SERVICE LED indications.

This LED will remain lit the entire time that the normally open switch is closed. The LED will be turned off immediately after resetting the switch (to the normally open position), or any time that the IDM is turned off. If the switch remains closed, and the IDM is turned on, the SERVICE LED will be turned on again after the 2 (+/-1) minutes.

This LED being turned on will have no effect on unit operation. It is an indicator only.

## Programmable zone sensor module test procedure

### Step 1

Verify all modes of operation, by running the unit through all of the steps in the «Test mode».

### Step 2

After verifying proper unit operation, exit the test mode. Turn the fan on continuously at the ZSM, by pressing the button with the fan symbol. If the fan comes on and runs continuously, the ZSM is good. If you are not able to turn the fan on, the ZSM is defective.

### ReliaTel™ default chart

If ReliaTel™ loses input from the building automation system, or the zone sensor module's heating and cooling setpoint (slide potentiometers), ReliaTel™ will control in the default mode after approximately 5 minutes. The temperature sensing thermistor in the zone sensor module is the ONLY component required for the default mode to operate.

**Table 16 - Default chart**

Component or function	Default operation
Cooling setpoint (CSP)	23°C
Heating setpoint (HSP)	21.5°C
Economizer	Normal operation
Economizer minimum	Normal operation Position
Mode	Normal operation, or auto if ZSM mode switch has failed
Fan	Normal operation, or continuous if fan mode switch on ZSM has failed
Night setback mode	Disabled - Used with programmable ZSM's only



# Test modes

## ECA test procedures

This series of tests will help you to diagnose, and determine where, and if a problem exists in the system economizer operation. Test 1 determines if the problem is in ReliaTel™, or if it is in the ECA. Test 2 will determine if the problem is in the ECA. Test 3 is for the minimum position potentiometer. Test 4 test sensor and exhaust fan outputs. Test 5 shows how to test the sensors. Conduct the tests in numerical order until problem is found.

### Verifying RTRM communication with ECA

ECA is communicating with RTRM if ECA's green system LED is flashing fast. See Table 3 for LED functions.

### Testing the ECA minimum position potentiometer

#### Step 1

After verifying the voltage presence, turn the minimum position potentiometer fully counter clockwise.

#### Step 2

Turn the minimum position potentiometer one half turn clockwise, so that the screw driver slot is straight up and down.

#### Step 3

Turn the minimum position potentiometer fully clockwise. If voltages measured are consistent with Steps 1, 2, 3, and 4 above, ReliaTel™, ECA potentiometer and circuitry are good.

## Conventional Thermostat test procedures

This series of tests will allow you test the output to the RTRM. Read DC voltage with Zone Sensor Module (ZSM) attached. If voltage read does not appear to be correct, read the resistance of the circuit, then the ZSM itself, to see if a problem exists in the ZSM or the wiring. With the ZSM not attached there should be 5.00 VDC at the terminals as shown. To check for induced voltage, read AC voltage to ground from each sensor wire. Should be less than 2VAC.

Problems to look for:

- Miswire/short/open
- Excessive resistance in circuit (corroded or loose connection)
- Setpoint level inaccurate (should be  $\pm 1^\circ\text{C}$  of chart)
- Induced voltage (high voltage wires in same conduit) Mode Input:

<b>Mode Input</b>	<b>RTRM J6-4</b>	<b>ZSM terminal 4</b>
<b>Common</b>	<b>RTRM J6-2</b>	<b>ZSM terminal 2</b>



## Test modes

Read DC voltage with Zone Sensor Module (ZSM) attached. If voltage read does not appear to be correct, read the resistance of the circuit, then the ZSM itself, to see if a problem exists in the ZSM or the wiring. With the ZSM not attached there should be 5.00 VDC at the terminals listed above. To check for induced voltage, read AC voltage to ground from each sensor wire. Should be less than 2VAC.

Problems to look for:

- Miswire/short/open
- Excessive resistance in circuit (corroded or loose connection)
- Induced voltage (high voltage wires in same conduit)

System Switch	Fan Switch	Ohms Rx1K	Volts DC + - 5%
Short to common		0	0.00
OFF	AUTO	2.32	0.94
COOL	AUTO	4.87	1.64
AUTO	AUTO	7.68	2.17
OFF	ON	10.77	2.59
COOL	ON	13.32	2.85
AUTO	ON	16.13	3.08
HEAT	AUTO	19.48	3.30
HEAT	ON	27.93	3.68
EM HEAT	AUTO	35.00	3.88
EM HEAT	ON	43.45	4.06
Open circuit			5.00



## Alarm Relay

---

Alarm relay is energized when the RTRM system led is blinking.

If the green LED on the RTRM is blinking with two ¼ second blinks every two seconds, one or more of the following diagnostics is present:

- Supply fan fail
- Zone temperature sensor input failure on CV units
- Programmable ZSM communication failure
- Manual compressor lockout (one or both circuits)
- Outdoor coil temp sensor failure (heat pumps only)
- Gas heat failure
- Discharge air temperature failure on modulating heat unit
- Froststat active
- Outdoor air temperature sensor failure
- Smoke detector active
- RTOM Comm. failure



# Troubleshooting

## Recommended steps

### Step 1

DO NOT disconnect unit power with disconnect switch, or diagnostic and failure status information will be lost.

### Step 2

Utilizing the porthole in the lower left hand corner of the control box, verify that the LED on ReliaTel™ is lit continuously. If LED is lit, go to Step 4.

### Step 3

If LED is not lit, verify presence of 24 VAC between LTB-16 and LTB-20. If 24 VAC is present, proceed to step 4. If 24 VAC is not present, test unit primary voltage, test transformer and fuse, test fuse in upper right hand corner of ReliaTel™. Proceed to Step 4 if necessary.

### Step 4

Test system status, heating status, and cooling status. If a system failure is indicated, proceed to step 5. If no failures are indicated, proceed to step 6.

### Step 5

If a system failure is indicated, recheck 2 and 3. If the LED is not lit in step 2, and 24 VAC is present in step 3, ReliaTel™ has failed. Replace ReliaTel™.

### Step 6

If no failures are indicated, place the system in the test mode, utilizing the «recommended test mode procedure». This procedure will allow you to test all of ReliaTel™ on-board outputs, and all of the off board controls (relays, contactors, etc.) that ReliaTel™ outputs energize, for each respective mode. Proceed to step 7.

### Step 7

Step the system through all of the available modes, and verify operation of all outputs, controls, and modes. If a problem in operation is noted in any mode, you may leave the system in that mode for up to 1 hour while troubleshooting. Refer to sequence of operations for each mode, to assist in verifying proper operation. Make repairs if necessary, and proceed to step 8, and 9.

### Step 8

If no abnormal operating conditions appear in the test mode, exit the test mode by cycling the unit power at the service disconnect. This verifies that all of ReliaTel™ on-board outputs and all of the controls the ReliaTel™ outputs energize are operational.

### Step 9

Refer to «individual component test procedures», if other microelectronic components are suspect.

### Failure status diagnostic

Refer to Table 3 - LED functions.

Table 17 - Troubleshooting

Symptom	Diagnostic	Response
<b>Demand Defrost Fault Designation</b>		
Delta T is below minimum value 12 minutes after defrost is terminated	Low delta T	If <2 hours, activate Defrost Fault Reset timer if delta T returns within bounds
Defrost Terminated on time requirement	Time Termination	If defrost is terminated on time requirement (vs. differential temperature), after 10 consecutive Time Terminations, activate Defrost Fault.
Delta T is above minimum value 12 minutes after defrost is terminated	High delta T	Initiate defrost, after 16 consecutive high delta T initiations, activate Defrost Fault.

# Troubleshooting

Defrost Termination Temperature (DTT) = Outdoor Air Temperature (OAT) + 8°C

14°C ≤ DTT ≤ 22°C

Delta T = Outdoor Air Temperature (OAT) - Outdoor Coil Temperature (OCT)

Defrost Initiate Temperature = 1.8 x (ΔT 12 Minutes After Defrost Mode is terminated)

### ReliaTel™

The RTRM has the ability to provide the service personnel with some unit diagnostics and system status information. Before turning the main power disconnect switch «Off», follow the steps below to check the RTRM. All diagnostics and system status information stored in the RTRM will be lost when the main power is turned «Off».

### **HAZARDOUS VOLTAGE! HIGH VOLTAGE IS PRESENT AT THE TERMINAL BLOCK OR UNIT MOUNTED DISCONNECT SWITCH.**

To prevent injury or death from electrocution, it is the responsibility of the technician to recognize this hazard and use extreme care when performing service procedures with the electrical power energized.

1. Verify that the Liteport LED on the RTRM is burning continuously. If the LED is lit, go to Step 3.
2. If the LED is not lit, verify that 24 VAC is presence between J1-1 and J1-2. If 24 VAC is present, proceed to Step 3. If 24 VAC is not present, check the unit main power supply, check transformer (TNS1). Proceed to Step 3 if necessary.
3. Utilizing «Method 1» or «Method 2» in «System Status Diagnostic», check the following: System status Heating status Cooling status If a System failure is indicated, proceed to Step 4. If no failures are indicated, proceed to Step 5.

4. If a System failure is indicated, recheck Steps 1 and 2. If the LED is not lit in Step 1, and 24 VAC is present in Step 2, the RTRM has failed. Replace the RTRM.
5. If no failures are indicated, use one of the TEST mode procedures described in «Unit Start-Up» to start the unit. This procedure will allow you to check all of the RTRM outputs, and all of the external controls (relays, contactors, etc.) that the RTRM outputs energize, for each respective mode. Proceed to Step 6.
6. Step the system through all of the available modes, and verify operation of all outputs, controls, and modes. If a problem in operation is noted in any mode, you may leave the system in that mode for up to one hour while troubleshooting. Refer to the sequence of operations for each mode, to assist in verifying proper operation. Make the necessary repairs and proceed to Steps 7 and 8.
7. If no abnormal operating conditions appear in the test mode, exit the test mode by turning the power «Off» at the main power disconnect switch.
8. Refer to the individual component test procedures if other microelectronic components are suspect.

### **System Status Checkout Procedure**

«System Status» is checked by using one of the following two methods:

#### **Method 1**

If the Zone Sensor Module (ZSM) is equipped with a remote panel with LED status indication, you can check the unit within the space. If the ZSM does not have LED's, use Method 2. THS/P03 have the remote panel indication feature. The LED descriptions are listed below.



# Troubleshooting

**LED 1 (System)** «On» during normal operation. «Off» if a system failure occurs or the LED fails. «Flashing» indicates test mode.

**LED 2 (Heat)** «On» when the heat cycle is operating. «Off» when the heat cycle terminates or the LED fails. «Flashing» indicates a heating failure.

**LED 3 (Cool)** «On» when the cooling cycle is operating. «Off» when the cooling cycle terminates or the LED fails. «Flashing» indicates a cooling failure.

**LED 4 (Service)** «On» indicates a clogged filter. «Off» during normal operation. «Flashing» indicates an evaporator fan failure

Below is the complete listing of failure indication causes.

### System failure

Check the voltage between terminals 6 and 9 on J6, it should read approximately 32 VDC. If no voltage is present, a System failure has occurred. Refer to Step 4 in the previous section for the recommended troubleshooting procedure.

### Heating Failure

Verify Heat Failure by Ignition Module (IGN) LED indicator:

### Cooling Failure

1. Cooling and heating set point (slide pot) on the zone sensor has failed. Refer to the «Zone Sensor Test Procedure» section.
2. Zone temperature thermistor ZTEMP on ZTS failed. Refer to «Zone Sensor Test Procedure».
3. CC1 or CC2 24 VAC control circuit has opened, check CC1 & CC2 coils, and any of the controls below that apply to the unit (HPC1, HPC2).
4. LPC1 has opened during the 3 minute minimum «on time» during 4 consecutive compressor starts, check LPC1 or LPC2 by testing voltage between the J1-1 & J3-2 terminals on the RTRM and ground. If 24 VAC is present, the LPC's has not tripped. If no voltage is present, LPC's has tripped.

OFF:	No Power or Failure
ON:	Normal
Slow Flash:	Normal, Heat Call
Fast Flash:	Error Code:
1 Flash:	Communication Failure
2 Flashes:	System Lockout
3 Flashes:	Pressure Switch Fail
4 Flashes:	TC01 or TC02 Open
5 Flashes:	Flame without Gas Valve
6 Flashes:	Flame Rollout Open

# Troubleshooting

---

## Service Failure

1. the supply fan proving switch has closed, the unit will not operate (when connected to RTOM), check the fan motor, belts, and proving switch.
2. Clogged filter switch has closed, check the filters.

## Simultaneous Heat and Cool Failure

1. Emergency Stop is activated

### Method 2

The second method for determining system status is done by checking voltage readings at the RTRM (J6). The system indication descriptions and the approximate voltages are listed below.

### System Failure

Measure the voltage between terminals J6-9 & J6-6. Normal Operation = approximately 32 VDC

System Failure = less than 1 VDC, approximately 0.75 VDC Test Mode = voltage alternates between 32 VDC & 0.75 VDC

### Heat Failure

Measure the voltage between terminals J6-7 & J6-6. Heat Operating = approximately 32 VDC

Heat Off = less than 1 VDC, approximately 0.75 VDC Heating Failure = voltage alternates between 32 VDC & 0.75 VDC

### Cool Failure

Measure the voltage between terminals J6-8 & J6-6. Cool Operating = approximately 32 VDC

Cool Off = less than 1 VDC, approximately 0.75 VDC Cooling Failure = voltage alternates between 32 VDC & 0.75 VDC

### Service Failure

Measure the voltage between terminals J6-10 & J6-6. Clogged Filter = Approximately 32 VDC.

Normal = Less than 1 VDC, approximately 0.75 VDC Fan Failure = voltage alternates between 32 VDC & 0.75 VDC.

To use LED's for quick status information at the unit, purchase a ZSM and connect wires with alligator clamps to terminals 6 through 10.

Connected each respective terminal wire (6 through 10) from the Zone Sensor to the unit J6 terminals 6 through 10.

**Note: If the system is equipped with a programmable zone sensor, THP03 the LED indicators will not function while the ZSM is connected.**

## Resetting Cooling and Ignition Lockouts

Cooling Failures and Ignition Lockouts are reset in an identical manner.

Method 1 explains resetting the system from the space; Method 2 explains resetting the system at the unit.

**Note: Before resetting Cooling Failures and Ignition Lockouts check the Failure Status Diagnostics by the methods previously explained. Diagnostics will be lost when the power to the unit is disconnected.**

### Method 1

To reset the system from the space, turn the «Mode» selection switch at the zone sensor to the «Off» position. After approximately 30 seconds, turn the «Mode» selection switch to the desired mode, i.e. Heat, Cool or Auto.

### Method 2

To reset the system at the unit, cycle the unit power by turning the disconnect switch «Off» and then «On».

Lockouts can be cleared through the BMS. Refer to the BMS instructions for more information.

## Zone Temperature Sensor (ZTS) Service Indicator

The ZSM SERVICE LED is a generic indicator that will signal the closing of a Normally Open switch at any time, providing the Indoor Motor (IDM) is operating. This indicator is usually used to indicate a clogged filter, or an airside fan failure.

The RTRM will ignore the closing of this Normally Open switch for 2 ( $\pm 1$ ) minutes. This helps prevent nuisance SERVICE LED indications. The exception is the LED will flash 40 seconds after the fan is turned «On» if the Fan Proving Switch is not made.



# Troubleshooting

## Clogged Filter Switch

This LED will remain lit the entire time that the Normally Open switch is closed. The LED will be turned off immediately after resetting the switch (to the Normally Open position), or any time that the IDM is turned «Off».

If the switch remains closed, and the IDM is turned «On», the SERVICE LED will be turned «On» again after the 2 (± 1) minute ignore delay.

This LED being turned «On», will have no other affect on unit operation. It is an indicator only.

## Fan Failure Switch

When the «Fan Failure» switch is wired to the RTOM, the LED will remain flashing the entire time the fan proving switch is closed, indicating a fan failure, and it will shut the unit operations down.

## Zone Temperature Sensor (ZTS) Test

**Note: These procedures are not for programmable or digital models and are conducted with the Zone Sensor Module electrically removed from the system.**

### Test 1

#### Zone Temperature Thermistor (ZTEMP)

This component is tested by measuring the resistance between terminals 1 and 2 on the Zone Temperature Sensor. Below are some typical indoor temperatures, and corresponding resistive values.

Zone or Set Point Temperature (°C)	Nominal ZTEMP Resistance	Nominal CSP or HSP Resistance
10	19.9 K-Ohms	889 Ohms
13	17.47 K-Ohms	812 Ohms
16	15.3 K-Ohms	695 Ohms
18	13.49 K-Ohms	597 Ohms
21	11.9 K-Ohms	500 Ohms
24	10.50 K-Ohms	403 Ohms
27	9.3 K-Ohms	305 Ohms
29	8.25 K-Ohms	208 Ohms
32	7.3 K-Ohms	110 Ohms

### Test 2

#### Cooling Set Point (CSP) and Heating Set Point (HSP)

The resistance of these potentiometers is measured between the following ZSM terminals. Refer to the chart above for approximate resistances at the given setpoint (SP).

Cool SP = Terminals 2 and 3

Range = 100 to 900 Ohms approximate

Heat SP = Terminals 2 and 5

Range = 100 to 900 Ohms approximate

### Test 3

#### System Mode and Fan Selection

The combined resistance of the Mode selection switch and the fan selection switch can be measured between terminals 2 and 4 on the Zone Sensor. The possible switch combinations are listed below with their corresponding resistance values.

# Troubleshooting

---

## Test 4

### LED Indicator Test, (SYS ON, HEAT, COOL & SERVICE)

#### Method 1

Testing the LED using a meter with diode test function. Test both forward and reverse bias. Forward bias should measure a voltage drop of 1.5 to 2.5 volts, depending on your meter. Reverse bias will show an Over Load, or open circuit indication if LED is functional.

#### Method 2

Testing the LED with an analog Ohmmeter. Connect Ohmmeter across LED in one direction, then reverse the leads for the opposite direction. The LED should have at least 100 times more resistance in reverse direction, as compared with the forward direction. If high resistance in both directions, LED is open. If low in both directions, LED is shorted.

#### Method 3

To test LED's with ZSM connected to unit, test voltages at LED terminals on ZSM. A measurement of 32 VDC, across an unlit LED, means the LED has failed.

**Note: Measurements should be made from LED common (ZSM terminal 6 to respective LED terminal). Refer to the Zone Sensor Module (ZSM) Terminal Identification table at the beginning of this section.**

#### Programmable & Digital Zone Sensor Test

##### Testing serial communication voltage

1. Verify 24 VAC is present between terminals J6-14 & J6-11.
2. Disconnect wires from J6-11 and J6-12. Measure the voltage between J6-11 and J6-12, should be about 32 VDC.
3. Reconnect wires to terminals J6-11 and J6-12. Measure voltage again between J6-11 and J6-12, voltage should flash high and low every 0.5 seconds. The voltage on the low end will measure about 19 VDC, while the voltage on the high end will measure from approximately 24 to 38 VDC.

4. Verify all modes of operation, by running the unit through all of the steps in the «Test Modes» section discussed in «Unit Start-Up».
5. After verifying proper unit operation, exit the test mode.

#### Unit Operation without a Zone Sensor

This procedure is for temporary operation only. The economizer and condenser fan cycling functions are disabled.

1. Open and Lock the unit disconnect switch.
2. Remove the Outside Air Sensor (OAS) from the condenser section of unit.
3. Use 2 wire nuts to individually cap the wires.
4. Locate the RTRM (J6). Connect two (2) wires to terminals J6-1 and 2.
5. Connect the sensor (OAS) using 2 wire nuts to the 2 field supplied wires that were connected to terminals 1 and 2 on J6.

#### Electro Mechanical Control

The IGN has the ability to provide the service personnel with some unit diagnostics and system status information. Before turning the main power disconnect switch «Off», follow the steps below to check the Ignition Module (IGN). Turn the fan on continuously at the ZSM, by pressing the button with the fan symbol. If the fan comes on and runs continuously, the ZSM is good. If you are not able to turn the fan on, the ZSM is defective.

#### ReliaTel™ Refrigeration Module (RTRM) Default Chart

If the TCI-R loses input from the BMS, the RTRM will control in the default mode after approximately 15 minutes. If the RTRM loses the Heating and Cooling setpoint input, the RTRM will control in the default mode instantaneously. The temperature sensing thermistor in the Zone Sensor Module is the only component required for the «Default Mode» to operate.



# Troubleshooting

---

## Unit Operation without a Zone Sensor

This procedure is for temporary operation only. The economizer and condenser fan cycling functions are disabled.

1. Open and Lock the unit disconnect switch.
2. Remove the Outside Air Sensor (OAS) from the condenser section of unit.
3. Use 2 wire nuts, to individually cap the wires.
4. Locate the RTRM (J6). Connect two (2) wires to terminals J6-1 and 2.
5. Connect the sensor (OAS) using two wire nuts to the 2 field supplied wires that were connected to terminals 1 and 2 on J6.

## Thermistor resistance temperature chart

This chart is identical in function to the thermistor resistance/temperature curve and is used on all thermistors in the microelectronic controls, with the exception of the programmable ZSM's on board thermistor, and the programmable ZSM's remote sensor.

### *Thermistor resistance temperature chart*

(°C)	(°F)	Nominal resistance (k Ohms)
-40	-40	350
-28	-20	170
-18	0	88
-7	20	47
4	40	26
16	60	15
27	80	9.3
38	100	5.8



# LCI-R LonTalk® Communication Interface

## General Information

The Communication Interface board allows ReliaTel™ controls to communicate on a LonTalk Network at the unit level. This product is intended to be installed by a qualified System Integrator properly trained and experienced in LonTalk networks. Network variables are based on the LonMark Space Comfort Controller Functional Profile Template. The LCI-R utilizes a Free Topology transceiver FTT-10A.

This channel is characterized by the following main features:

- It consists of up to 60 nodes on a single network segment
- Data rate: 78 125 kbps
- Maximum distance: 1400 meters

- Recommended topology: daisy chain with double end terminator (105 ohms). For further details, refer to the official documentation LonWorks®FTT-10A free topology transceiver user's guide and to the official LonWorks®guidelines Lonmark®layer 1-6 interoperability guidelines version 3.0. These documents and additional information are available on the internet site [www.lonmark.org](http://www.lonmark.org)

Figure 7 - LCI-R LonTalk® Communication Interface Layout

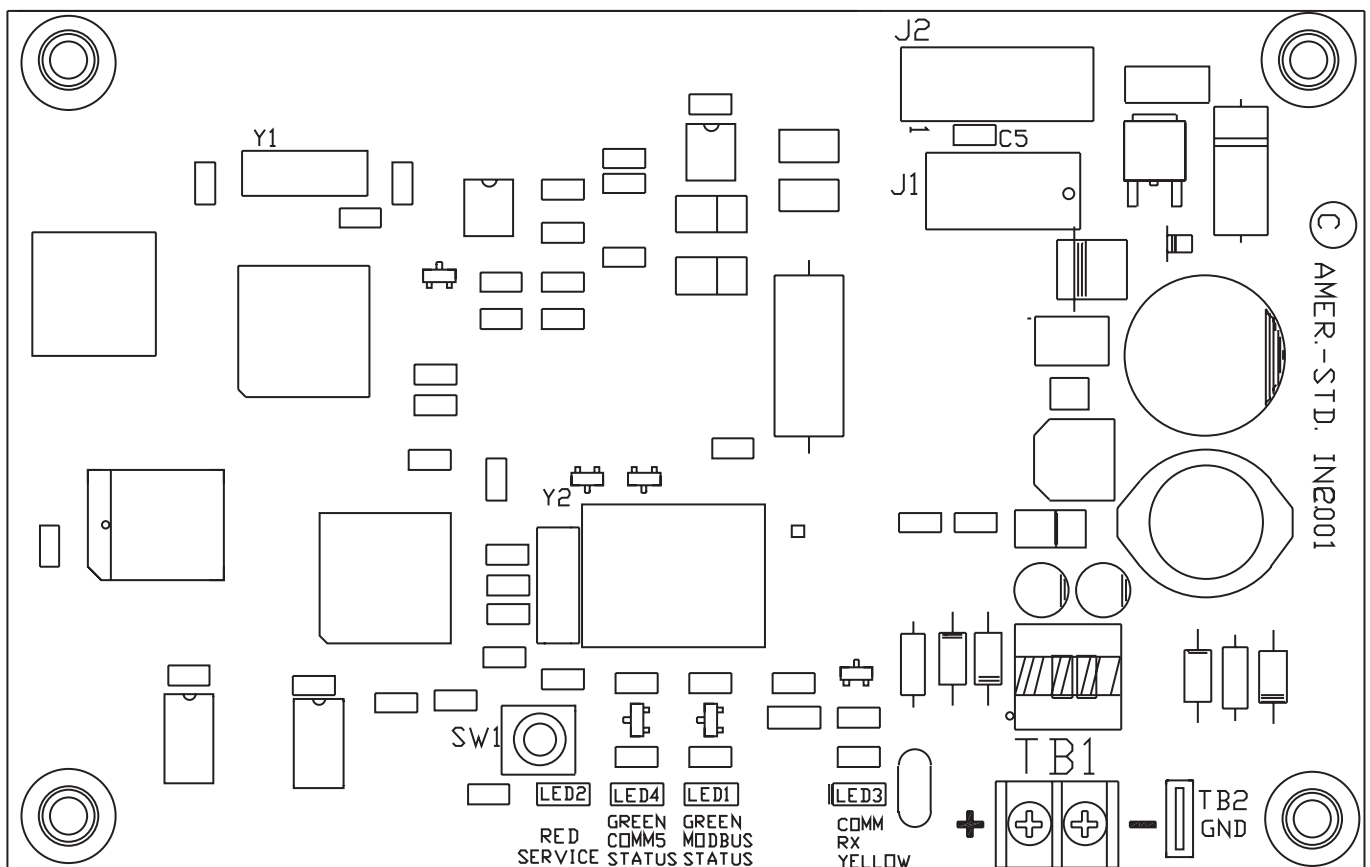



# LCI-R LonTalk® Communication Interface

## Wiring Requirements

The Communications link wiring is dependent on the network architecture. It is recommended that a System Integrator refer to «LonWorks FTT-10A Free Topology Transceiver User's Guide» by the Echelon Corporation for proper wire selection. The physical limits are defined in Chapter 4, Network Cabling And Connection. This User's Guide is available on the Echelon Web page. A typical wire recommendation is Belden 85102, single twisted pair, stranded 19/29, unshielded, 150 C.

## Status/Power/Wink/Test LED (STATUS LED)

The LCI-R board includes a green Status LED located near the middle of the board (Figure 7). The operation for this LED is defined as follows:

- + *ON - Power is applied and the LCI-R is normal.*
- + *OFF - There is either no power applied or the LCI is unconfigured or offline.*
- + *Blinking twice per second for 10 seconds - The LCI-R has been commanded to WINK.*
- + *Continuous Blinking ; ON for 2.25 seconds , OFF for .25 seconds - The unit is in a TEST mode.*

## Wink Response

The LCI-R responds to a network «Wink Request». Upon receipt of a Wink request the LCI-R will blink (0.25 second ON, 0.25 second OFF, 0.25 second ON, etc.) the STATUS LED continuously for 10 seconds. This Wink response is available both when the LCI-R node is configured and when it is unconfigured.

## Communication LED

### (COMM LED)

The LCI-R board includes a yellow COMM LED located left of the TB1 terminal. (Figure 8). The operation for this LED is defined as follows:

- + *Flickering - When communication activity is detected on the network. (This LED is not effected by transmitting data from the LCI-R.)*
- + *OFF - No current activity on the Network.*

## Service Switch

### (SERVICE LED)

The LCI-R board includes a Service push-button switch (also known as Service Pin) and Service LED. The Service Switch is located on the bottom middle of the board (Figure 8). and may be used during configuration, installation, and maintenance of the node. The operation of the Switch button is as follows:

- + *Temporary press - Broadcast Neuron ID and Program ID*
- + *Extended press (more than 15 seconds) - Force the node to its unconfigured state.*

**Note:** An Extended Press will disable the LCI-R completely and a network management tool will be required to put the LCI-R back into operation.

Provisions for holding the Timed Override button for 10 seconds will generate a Service Pin broadcast equal to a Service Pin temporary press.

The LCI-R board includes a red Service LED located above the Service Switch (Figure 8). The operation for this LED is defined as follows:

State	LED Output
Normal	Steady OFF
Bad Hardware	Steady ON
Unconfigured State	Flashing 1 second ON, 1 second OFF
Watchdog Timer Reset Occurring	Repeated flash

The Service LED turns on while the Service pin is being depressed.



# LCI-R LonTalk® Communication Interface

## Modbus STATUS

### (Modbus LED)

The LCI-R Board includes a Green COMM 4 LED located to the right of the TB2 terminal block (Figure 8). This LED indicates communication between the LCI-R and the ReliaTel™. The operation for this LED is defined as follows:

State	LED Output
Normal Operation	Steady ON
LCI-R not operating	Steady OFF
ReliaTel not responding	Flashing - 0.25 seconds ON, 2.0 seconds OFF

## Network Interface

The LCI-R contains 2 objects. Object index 0 is the Node Object. Object index 1 is the Rooftop Object. The integer in the left column is the network variable index used for reference during binding or to perform a network variable browse. This index is different from the Space Comfort Controller (SCC) Functional Profile Template index as shown.

**Table 18 - Rooftop Object Network Variables - Inputs**

NV Index	SCC Index	SNVT Type	NV Name
0	NV#1	SNVT_temp_p	nviSpaceTemp
1	NV#2	SNVT_temp_p	nviSetpoint
2	NV#3	SNVT_temp_p	nviSetpointOffset
3	NV#5	SNVT_tod_event	nviOccSchedule
4	NV#6	SNVT_occupancy	nviOccManCmd
5	NV#7	SNVT_occupancy	nviOccSensor
6	NV#8	SNVT_hvac_mode	nviApplicMode
7	NV#9	SNVT_hvac_mode	nviHeatCool
8	NV#11	SNVT_switch	nviComprEnable
9	NV#12	SNVT_switch	nviAuxHeatEnable
10	NV#13	SNVT_switch	nviEconEnable
11	NV#17	SNVT_hvac_emerg	nviEmergOverride
15		SNVT_switch	nviFanModeCmd
16	NV#59	SNVT_lev_percent	nviOAMinPos
17	NV#22	SNVT_ppm	nviSpaceIAQ
18	NV#20	SNVT_lev_percent	nviSpaceRH
19	NV#19	SNVT_temp_p	nviOutdoorTemp
20	NV#21	SNVT_lev_percent	nviOutdoorRH

**Table 19 - Rooftop Object Network Variables - Outputs**

NV Index	SCC Index	SNVT Type	NV Name
23	NV#26	SNVT_temp_p	nvoSpaceTemp
24	NV#27	SNVT_hvac_status	nvoUnitStatus
25	NV#28	SNVT_temp_p	nvoEffectSetpt
26	NV#29	SNVT_occupancy	nvoEffectOccup
27	NV#30	SNVT_hvac_mode	nvoHeatCool
28	NV#31	SNVT_temp_p	nvoSetpoint
29	NV#33	SNVT_switch	nvoFanSpeed
30	NV#34	SNVT_temp_p	nvoDischAirTemp
31	NV#36	SNVT_Power_Kilo	nvoLoadAbsK
32	NV#37	SNVT_lev_percent	nvoTerminalLoad
33	NV#42	SNVT_lev_percent	nvoOADamper
34	NV#43	SNVT_lev_percent	nvoSpaceRH
35	NV#44	SNVT_lev_percent	nvoOutdoorRH
36	NV#45	SNVT_temp_p	nvoOutdoorTemp
37	NV#46	SNVT_ppm	nvoSpaceCO2
40		SNVT_str_asc	nvoAlarmMessage
41		SNVT_temp_p	nvoMATemp
42		SNVT_temp_p	nvoRATemp
46	NV#64	SNVT_temp_p	nvoMixedAirTemp



# TCI-R communication interface (Comm 3 / Comm 4)

## General information

The first generation of Reliabel™ communications module incorporates communications capabilities of the TCI-1 (Isolated Comm 3), TCI-2 (Non-Isolated Comm 3 or Comm 4 or Isolated Comm 3) board and TCI-3 (Non-Isolated Comm 3 or Comm 4).

The TCI module allows digital communication between Reliabel™ controls and Trane ICS systems which include Tracer Summit™, Tracker™ Stat 4, Tracker™, Stat 7, Tracker™ Stat 16, and the VariTrac® zoning system.

The TCI module in the non-insulated Comm 3 / Comm 4 position allows communication between a Reliabel™ controlled unit and a Tracer Summit™ or VariTrac™ zoning system.

By turning the Comm Link Board 90°, the Comm 3/4 communications module now becomes Isolated Comm 3 and can be used to communicate with Tracker™ or Tracer 100 systems.

**Note: The TCI module in the kit is shipped in the comm 4 position.**

*Figure 8 - Typical Reliabel™ communications applications (Package units)*

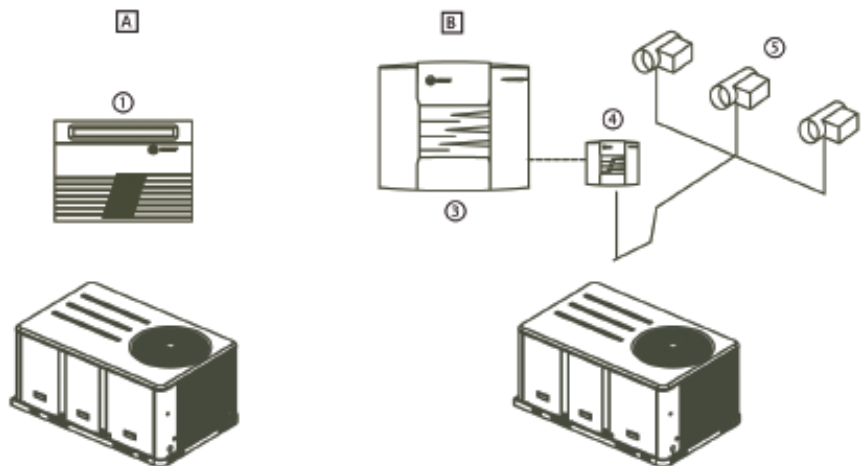

- A = Tracker™, Tracer 100.
- 1 = Trane Building Management System
- 2 = Isolated Comm 3 communication option
- B = VariTrac™
- 3 = Option
- 4 = VariTrac™ CCP
- 5 = VariTrac™, Zone dampers
- 6 = Non-isolated Comm 3 or Comm 4 communication option
- C = Tracer Summit™
- 7 = Non-isolated Comm 3, Comm 4, or isolated Comm3 communication option

# TCI-R communication interface (Comm 3 / Comm 4)

Figure 9 - Communications module, Type 1 configuration

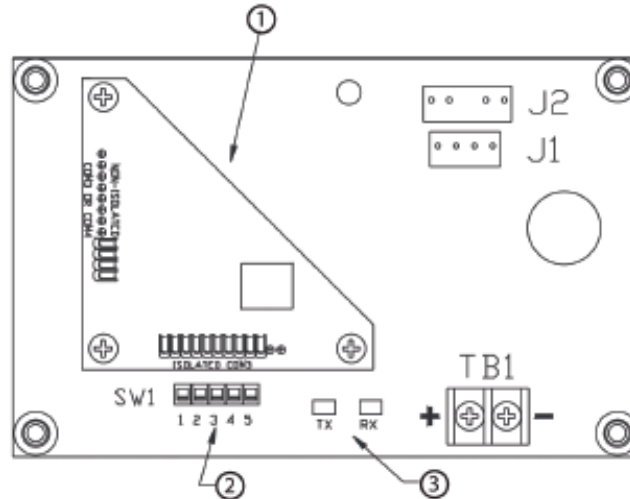

- 1 = Comm link board in isolated comm 3 position
- 2 = Dip switch
- 3 = Communication Leds

Figure 10 - Communications module, Type 2 configuration

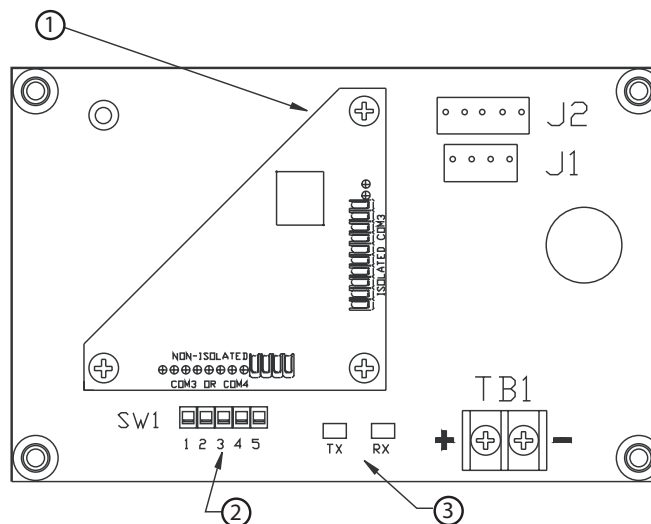

- 1 = Comm link board in non-isolated comm 3 or comm 4 position
- 2 = Dip switch
- 3 = Communication Leds



# TCl-R communication interface (Comm 3 / Comm 4)

## DIP switch address settings

The DIP switch (SW1) is located on the left corner of the Comm 3/4 board. DIP switches SW1-1 through SW1-5 are used to set the Comm 3/4 board addresses.

### Setting for Tracker™/ComforTrac (Pre Version 10 Trackers)

The Comm 3/4 board is supported by Tracker™/ComforTrac Building Management Systems. The Comm link board must be positioned for Isolated Comm 3 communications. A maximum of 12 interfaces can be defined for each Tracker™/ ComforTrac system.

**Table 20 - TCl communications module address setting for Tracker™/ComforTrac**

Address numbers	The Reliatel™ communications interface board DIP switch settings				
	SW1-1	SW1-2	SW1-3	SW1-4	SW1-5
1	OFF	OFF	OFF	OFF	OFF
2	OFF	OFF	OFF	OFF	ON
3	OFF	OFF	OFF	ON	OFF
4	OFF	OFF	OFF	ON	ON
5	OFF	OFF	ON	OFF	OFF
6	OFF	OFF	ON	OFF	ON
7	OFF	OFF	ON	ON	OFF
8	OFF	OFF	ON	ON	ON
9	OFF	ON	OFF	OFF	OFF
10	OFF	ON	OFF	OFF	ON
11	OFF	ON	OFF	ON	OFF
12	OFF	ON	OFF	ON	ON

**Table 21 - Comm 3/4 communications module, Address setting for VariTrac™ I comfort manager and VariTrac™ II central control panel**

Address numbers	The Reliatel™ communications interface board DIP switch settings				
	SW1-1	SW1-2	SW1-3	SW1-4	SW1-5
ALL	ON	ON	ON	ON	ON

**Table 22 - TCl communications module, Address setting for VariTrac™ III central control panel**

Address numbers	The Reliatel™ communications interface board DIP switch settings				
	SW1-1	SW1-2	SW1-3	SW1-4	SW1-5
ALL	OFF	OFF	OFF	OFF	OFF



# TCI-R communication interface (Comm 3 / Comm 4)

## Settings for Tracer 100 Series panels and Tracer Summit™ systems

Tracer 100 has a maximum of 32 Comm 3/4 communications modules that can be defined for each Tracer 100 and Tracer 100i. A maximum of 20 Comm 3/4 communications modules can be defined for each Tracer L and Tracer Monitor.

**Note: The number of ReliaTel™ communications interfaces supported by Tracers is dependent on the software version being used. Refer to Tracer 100 Series literature for specific quantities.**

Tracer Summit™ allows a maximum of 32 Tracer addresses per link for high capacity or 16 addresses for standard capacity.

The range of Tracer address numbers that may be defined for Comm 3/4 communications modules is 50 through 81. To configure an address for a unit, assign its point number (i.e. 30-01, 30-02, 30-03, etc.) to a Tracer address within the acceptable range (50-81) as shown in Table 16. Set the Comm 3/ 4 communications module DIP switches for this address.

*Table 23 - TCI communications module, Address setting for Tracer 100 Series panels and Tracer Summit™*

Address numbers	The ReliaTel™ communications interface board DIP switch settings				
56	OFF	OFF	ON	ON	OFF
57	OFF	OFF	ON	ON	ON
58	OFF	ON	OFF	OFF	OFF
59	OFF	ON	OFF	OFF	ON
60	OFF	ON	OFF	ON	OFF
61	OFF	ON	OFF	ON	ON
62	OFF	ON	ON	OFF	OFF
63	OFF	ON	ON	OFF	ON
64	OFF	ON	ON	ON	OFF
65	OFF	ON	ON	ON	ON
66	ON	OFF	OFF	OFF	OFF
67	ON	OFF	OFF	OFF	ON
68	ON	OFF	OFF	ON	OFF
69	ON	OFF	OFF	ON	ON
70	ON	OFF	ON	OFF	OFF
71	ON	OFF	ON	OFF	ON
72	ON	OFF	ON	ON	OFF
73	ON	OFF	ON	ON	ON
74	ON	ON	OFF	OFF	OFF
75	ON	ON	OFF	OFF	ON
76	ON	ON	OFF	ON	OFF
77	ON	ON	OFF	ON	ON
78	ON	ON	ON	OFF	OFF
79	ON	ON	ON	OFF	ON
80	ON	ON	ON	ON	OFF
81	ON	ON	ON	ON	ON

# PIC Modbus

## Modbus Functions

Function 2: Read  $n$  bits

Inputs are addressed starting at zero: input 10001 is addressed as 0.

Function 4: Read  $n$  analog values

Registers are addressed starting at zero: register 30001 is addressed as 0.

Function 5: Write a bit

Function 15: Write  $n$  bits

Coils are addressed starting at zero: coil 00001 is addressed as 0.

Function 6: Write a remote setpoint

Function 16: Write  $n$  remote setpoints

Registers are addressed starting at zero: register 40001 is addressed as 0.

## Modbus Configuration

There are 2 blocks of dip switches dedicated to Modbus configuration.

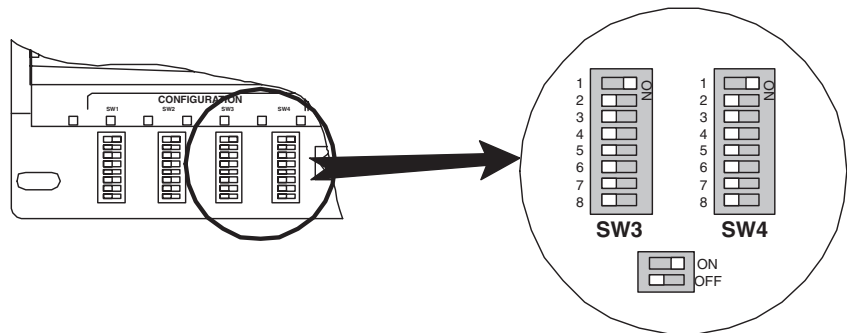

Dip switch block SW3: Serial Type, Parity, Baudrate

Dip switch block SW4: Modbus slave address

### Modbus parameters - SW3

Table 24 - SW3 - Modbus configuration

		1	2	3	4	5	6	7	8
Serial Type	<b>RS232</b>	ON							Reserved
	<b>RS485</b>	OFF							
Parity Check	<b>None</b>		OFF	OFF					
	<b>Odd</b>		ON	ON					
	<b>Even</b>		OFF	ON					
Baudrate	<b>1200</b>				OFF	OFF	OFF		
	<b>2400</b>				ON	OFF	OFF		
	<b>4800</b>				OFF	ON	OFF		
	<b>9600</b>				ON	ON	OFF		
	<b>14400</b>				OFF	OFF	ON		
	<b>38400</b>				OFF	ON	ON		
	<b>57600</b>				ON	ON	ON		





# PIC Modbus

## Modbus slave address - SW4

To configure the PIC slave address (from 1 to 247), the dip switches SW4 should be configured according to the following table.

**Table 25 - SW4 - Modbus slave address**

SW4 - Modbus Slave Address								
Address	1	2	3	4	5	6	7	8
1	ON	OFF	OFF	OFF	OFF	OFF	OFF	OFF
2	OFF	ON	OFF	OFF	OFF	OFF	OFF	OFF
3	ON	ON	OFF	OFF	OFF	OFF	OFF	OFF
4	OFF	OFF	ON	OFF	OFF	OFF	OFF	OFF
5	ON	OFF	ON	OFF	OFF	OFF	OFF	OFF
6	OFF	ON	ON	OFF	OFF	OFF	OFF	OFF
7	ON	ON	ON	OFF	OFF	OFF	OFF	OFF
8	OFF	OFF	OFF	ON	OFF	OFF	OFF	OFF
9	ON	OFF	OFF	ON	OFF	OFF	OFF	OFF
10	OFF	ON	OFF	ON	OFF	OFF	OFF	OFF
11	ON	ON	OFF	ON	OFF	OFF	OFF	OFF
12	OFF	OFF	ON	ON	OFF	OFF	OFF	OFF
13	ON	OFF	ON	ON	OFF	OFF	OFF	OFF
14	OFF	ON	ON	ON	OFF	OFF	OFF	OFF
15	ON	ON	ON	ON	OFF	OFF	OFF	OFF
16	OFF	OFF	OFF	OFF	ON	OFF	OFF	OFF
17	ON	OFF	OFF	OFF	ON	OFF	OFF	OFF
18	OFF	ON	OFF	OFF	ON	OFF	OFF	OFF
19	ON	ON	OFF	OFF	ON	OFF	OFF	OFF
20	OFF	OFF	ON	OFF	ON	OFF	OFF	OFF
21	ON	OFF	ON	OFF	ON	OFF	OFF	OFF
22	OFF	ON	ON	OFF	ON	OFF	OFF	OFF
23	ON	ON	ON	OFF	ON	OFF	OFF	OFF
24	OFF	OFF	OFF	ON	ON	OFF	OFF	OFF
25	ON	OFF	OFF	ON	ON	OFF	OFF	OFF
26	OFF	ON	OFF	ON	ON	OFF	OFF	OFF
27	ON	ON	OFF	ON	ON	OFF	OFF	OFF
28	OFF	OFF	ON	ON	ON	OFF	OFF	OFF
29	ON	OFF	ON	ON	ON	OFF	OFF	OFF
30	OFF	ON	ON	ON	ON	OFF	OFF	OFF



# PIC Modbus

*Table 25 - Continued*

SW4 - Modbus Slave Address								
Address	1	2	3	4	5	6	7	8
31	ON	ON	ON	ON	ON	OFF	OFF	OFF
32	OFF	OFF	OFF	OFF	OFF	ON	OFF	OFF
33	ON	OFF	OFF	OFF	OFF	ON	OFF	OFF
34	OFF	ON	OFF	OFF	OFF	ON	OFF	OFF
35	ON	ON	OFF	OFF	OFF	ON	OFF	OFF
36	OFF	OFF	ON	OFF	OFF	ON	OFF	OFF
37	ON	OFF	ON	OFF	OFF	ON	OFF	OFF
38	OFF	ON	ON	OFF	OFF	ON	OFF	OFF
39	ON	ON	ON	OFF	OFF	ON	OFF	OFF
40	OFF	OFF	OFF	ON	OFF	ON	OFF	OFF
41	ON	OFF	OFF	ON	OFF	ON	OFF	OFF
42	OFF	ON	OFF	ON	OFF	ON	OFF	OFF
43	ON	ON	OFF	ON	OFF	ON	OFF	OFF
44	OFF	OFF	ON	ON	OFF	ON	OFF	OFF
45	ON	OFF	ON	ON	OFF	ON	OFF	OFF
46	OFF	ON	ON	ON	OFF	ON	OFF	OFF
47	ON	ON	ON	ON	OFF	ON	OFF	OFF
48	OFF	OFF	OFF	OFF	ON	ON	OFF	OFF
49	ON	OFF	OFF	OFF	ON	ON	OFF	OFF
50	OFF	ON	OFF	OFF	ON	ON	OFF	OFF
51	ON	ON	OFF	OFF	ON	ON	OFF	OFF
52	OFF	OFF	ON	OFF	ON	ON	OFF	OFF
53	ON	OFF	ON	OFF	ON	ON	OFF	OFF
54	OFF	ON	ON	OFF	ON	ON	OFF	OFF
55	ON	ON	ON	OFF	ON	ON	OFF	OFF
56	OFF	OFF	OFF	ON	ON	ON	OFF	OFF
57	ON	OFF	OFF	ON	ON	ON	OFF	OFF
58	OFF	ON	OFF	ON	ON	ON	OFF	OFF
59	ON	ON	OFF	ON	ON	ON	OFF	OFF
60	OFF	OFF	ON	ON	ON	ON	OFF	OFF
61	ON	OFF	ON	ON	ON	ON	OFF	OFF
62	OFF	ON	ON	ON	ON	ON	OFF	OFF
63	ON	ON	ON	ON	ON	ON	OFF	OFF
64	OFF	OFF	OFF	OFF	OFF	OFF	ON	OFF

# PIC Modbus

---

## Variable format

Temperature:

Offset: -45 °C

Scaling: 10

Conversion:

When the BMS receives a data, the following equation has to be applied

$$\text{Temperature} = (\text{data received} / 10) - 45$$

When the BMS sends a data, the following equation has to be applied

$$\text{Data to send} = (\text{Temperature} + 45) * 10$$

Percentage:

Offset = 0

Scaling = 1

Without unit:

Offset = 0

Scaling = 1

## PIC and Trane Equipment configuration

### Configure the PIC connected to a Comm3 Trane Equipment

**Step 1: Configure PIC dip switches SW1 and SW2 according to the existing Trane Equipment**

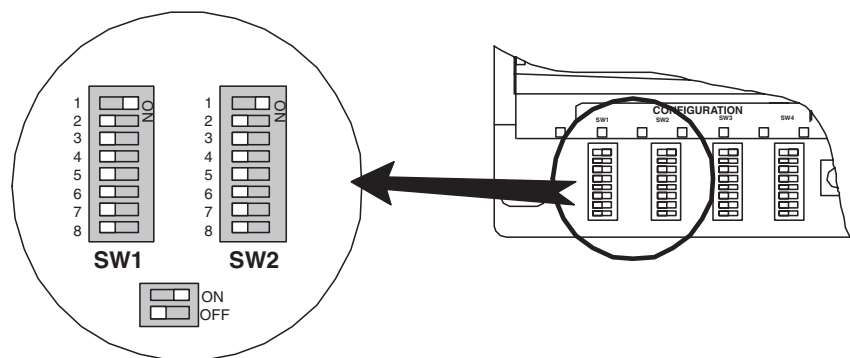

# PIC Modbus

Table 26

SW1 - Trane Equipment Configuration									
Trane Equipment	Controller	1	2	3	4	5	6	7	8
WSD / WSH / WKD / WKH / TCD / TCH / TED / TEH / TSD / TSH / TKD / TKH / YCD / YCH / YSD / YSH / YKD / YKH	Reliatel or UCP II	ON	OFF	OFF	OFF	Reserved			ON

Table 27

SW2 - Trane Equipment Configuration									
Trane Equipment	Controller	1	2	3	4	5	6	7	8
WSD / WSH / WKD / WKH / TCD / TCH / TED / TEH / TSD / TSH / TKD / TKH / YCD / YCH / YSD / YSH / YKD / YKH	Reliatel or UCP II	OFF	OFF	OFF	OFF	OFF	OFF	Reserved	

### Step 2: Validate the PIC configuration

Once the PIC is configured and wired to Trane equipment, the configuration has to be validated.

The PIC service pin has to be pressed for at least **15 seconds**. This will save the configuration and reset the PIC.

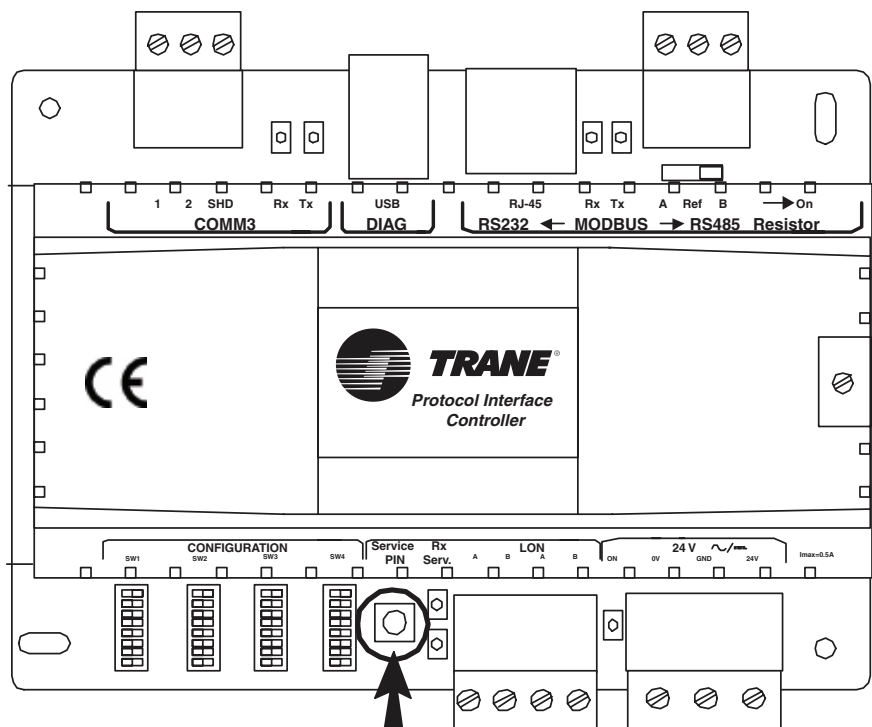

Service Pin



# PIC Modbus

**Table 28 - Data Point List for Rooftops, Reliatel controllers**

Data Type	Function	Modbus Index	Offset	Point Description	Unit		
Binary Outputs	5/15	00001	0	ICS Diagnostic Reset (1 = Yes 0 = No)	bit		
		00002	1	Factory Test (***) Factory Use Only (***) (1 = Yes 0 = No)	bit		
		00003	2	ICS Slave Mode Requested (1 = Yes 0 = No)	bit		
		00004	3	Unit Control Source (1 = ICS 0 = Local)	bit		
		00005	4	Supply Fan Mode (1 = On (Continuous) 0 = Auto)	bit		
		00006	5	Econ Drive Open (1 = Drive Open 0 = Auto)	bit		
		00007	6	Econ Drive Closed (1 = Drive Closed 0 = Auto)	bit		
		00008	7	Econ Drive to Min Pos (1 = Drive to Min Position 0 = Auto)	bit		
		00009-00010	8-9	Economizer Control (bits 00009 00010) 0 0 Economizer Disabled 0 1 Economizer Disabled 1 0 Use Local Economizer Enthalpy Request (AUTO) 1 1 Override Local Economizer Enthalpy Request (ENABLED)			
		00011	10	ICS Manual Heat/Cool Override (1 = Manual 0 = Auto)	bit		
		00012	11	ICS Manual Override Selection (1 = Cool 0 = Heat)	bit		
		00013	12	ICS Unit Stop Request (1 = Off 0 = Auto)	bit		
		00014	13	Supply Air Tempering Request (1 = Enable 0 = Disable)	bit		
		00015	14	Emergency Heat Mode Req (Heat Pump Only) (1 = Em Heat 0 = Auto)	bit		
		00016	15	Emergency Stop Request (1 = Yes 0 = No)	bit		
		00017	16	Auxiliary Heat Lockout (1 = Not Locked Out 0 = Lock Out)	bit		
		00018	17	Compressor Lockout (Lockout Both) (1 = Not Locked Out 0 = Lock Out)	bit		
		Analog Outputs	6/16	40001	0	Slave State Number ( 0 to 10 and 12)	None
40002	1			Economizer Damper Minimum Position ( 0 to 50 %)	Percentage		
40003	2			ICS Zone Cooling Setpoint	Temperature		
40004	3			ICS Zone Heating Setpoint	Temperature		
40005	4			Number of Cooling Stages to be Enabled ( 0 to 3 )	None		
40006	5			Number of Heating Stages to be Enabled ( 0 to 3 )	None		
40007	6			Bit 0 Econ Drive to Min Pos (1 = Drive to Min Position 0 = Auto)			
				Bit 1 Econ Drive Closed (1 = Drive Closed 0 = Auto)			
				Bit 2 Econ Drive Open (1 = Drive Open 0 = Auto)			
				Bit 3 Supply Fan Mode (1 = On (Continuous) 0 = Auto)			
				Bit 4 Unit Control Source (1 = ICS 0 = Local)			
				Bit 5 ICS Slave Mode Requested (1 = Yes 0 = No)			
				Bit 6 Factory Test (***) Factory Use Only (***) (1 = Yes 0 = No)			
Bit 7 ICS Diagnostic Reset (1 = Yes 0 = No)				bitfield			
40008	7			Bit 0 Emergency Stop Request (1 = Yes 0 = No)			
				Bit 1 Emergency Heat Mode Req (Heat Pump Only) (1 = Em Heat 0 = Auto)			
				Bit 2 Supply Air Tempering Request (1 = Enable 0 = Disable)			
				Bit 3 ICS Unit Stop Request (1 = Off 0 = Auto)			
		Bit 4 ICS Manual Override Selection (1 = Cool 0 = Heat)					
		Bit 5 ICS Manual Heat/Cool Override (1 = Manual 0 = Auto)					
		Bit 6, 7 Economizer Control (bits 7 6)					
		0 0 Economizer Disabled					
		0 1 Economizer Disabled					
		1 0 Use Local Economizer Enthalpy Request (AUTO)					
		1 1 Override Local Economizer Enthalpy Request (ENABLED)			bitfield		



# PIC Modbus

Table 28 - Continued

Data Type	Function	Modbus Index	Offset	Point Description	Unit	
Analog Outputs	6/16	40009	8	Bit 0 Compressor Lockout (Lockout Both) (1 = Not Locked Out 0 = Lock Out)	bitfield	
				Bit 1 Auxiliary Heat Lockout (1 = Not Locked Out 0 = Lock Out)		
				Bit 2 Lead/Lag Enable/Disable (1 = Enabled 0 = Disabled)		
				Bit 3 Zone Temperature Source (1 = Echelon 0 = Local)		
				Bit 4 Economizer Min Position Setpoint Source (1 = ICS 0 = Local)		
				Bit 5 Power Exhaust Setpoint Source (1 = ICS 0 = Local)		
				Bit 6 Reset Select Input Source (VAV Only) (1 = ICS 0 = Local)		
		40010	9	Reserved for BAS 1	None	
		40011	10	Reserved for BAS 2	None	
Binary Inputs	2		10004	3	Gemini Unit (1 = Yes 0 = No)	bit
			10005	4	Economizer Installed (1 = Installed 0 = Not Installed)	bit
			10006	5	Gas or Electric (1 = Gas Heat 0 = Electric Heat)	bit
			10007	6	Heat Pump (Voyager I & II Only) (1 = Yes 0 = No)	bit
			10008	7	Compressor 1 Exists (1 = Yes 0 = No)	bit
			10009	8	Compressor 1 Cycling Input (1 = Normal 0 = Disabled)	bit
			10010	9	HPC for Compressor 1 (1 = High Press 0 = Normal)	bit
			10011	10	Compressor 1 Locked Out (1 = Yes 0 = No)	bit
			10012	11	Compressor On or Off (1 = On 0 = Off)	bit
			10013	12	Compressor 2 Exists (1 = Yes 0 = No)	bit
			10014	13	Compressor 2 Cycling Input (1 = Normal 0 = Disabled)	bit
			10015	14	HPC for Compressor 2 (1 = High Press 0 = Normal)	bit
			10016	15	Compressor 2 Locked Out (1 = Yes 0 = No)	bit
			10017	16	Compressor On or Off (1 = On 0 = Off)	bit
			10019	18	Return Humidity Sensor Failed (1 = Yes 0 = No)	bit
			10020	19	Return Air Temperature Sensor Failed (1 = Yes 0 = No)	bit
			10021	20	Outdoor Humidity Sensor Failed (1 = Yes 0 = No)	bit
			10022	21	Supply Air Temperature Sensor Failed (Mixed) (1 = Yes 0 = No)	bit
			10023	22	Outdoor Air Temperature Sensor Failed (1 = Yes 0 = No)	bit
			10024	23	Zone Temperature Sensor Failed (1 = Yes 0 = No)	bit
			10025	24	Economizer Fault (1 = Yes 0 = No)	bit
			10026	25	Coil Temperature Sensor Failed (1 = Yes 0 = No)	bit
			10027	26	Local Zone Cooling Setpoint Failed (1 = Yes 0 = No)	bit
			10028	27	Local Zone Heating Setpoint Failed (1 = Yes 0 = No)	bit
			10030	29	Filter Clogged Failure (1 = Yes 0 = No)	bit
			10031	30	Heat Failure (1 = Yes 0 = No)	bit
			10032	31	High Temperature Input is Hot / Smoke Detector (1 = Yes 0 = No)	bit
			10033	32	Heat Stage 3 Exists (1 = Yes 0 = No)	bit
			10034	33	Heat Stage 2 Exists (1 = Yes 0 = No)	bit
			10035	34	Not Used - Reserved for UCP (1 = Yes 0 = No)	bit
			10036	35	Emergency Heat Mode (Heat Pump Only) (1 = Yes 0 = No)	bit
			10037	36	Supply Fan Mode (1 = On 0 = Auto)	bit
			10038	37	Manual/Auto Mode (1 = Manual 0 = Auto)	bit
			10039	38	Heat/Cool Mode (1 = Cool 0 = Heat)	bit
			10040	39	Off Mode (1 = Off 0 = Auto)	bit
			10041	40	Timed Override Request (1 = Yes 0 = No)	bit
			10042	41	Test Mode in Progress (1 = Yes 0 = No)	bit
			10043	42	Decision to Economize (1 = Enabled 0 = Disabled)	bit
			10045	44	Power Up Failure has Occurred (1 = Yes 0 = No)	bit
			10046	45	Heat Pump Defrost is Active (1 = Yes 0 = No)	bit
			10047	46	Evaporator Defrost is Active (1 = Yes 0 = No)	bit



# PIC Modbus

Table 28 - Continued

Data Type	Function	Modbus Index	Offset	Point Description	Unit		
Binary inputs	2	10048	47	Supply Air Tempering is Active (1 = Yes 0 = No)	bit		
		10049	48	Exhaust Fan is Energized (1 = Yes 0 = No)	bit		
		10050	49	Condenser Fan A is Energized (1 = Yes 0 = No)	bit		
		10051	50	Condenser Fan B is Energized (1 = Yes 0 = No)	bit		
		10052	51	Heat Output 1 is Energized (1 = Yes 0 = No)	bit		
		10053	52	Heat Output 2 is Energized (1 = Yes 0 = No)	bit		
		10054	53	Reverse Valve is Energized (1 = Yes 0 = No)	bit		
		10055	54	Supply Fan is Energized (1 = Yes 0 = No)	bit		
		10059	58	Clogged Filter Local Input (1 = Yes 0 = No)	bit		
		10060	59	Compressor 2 Cycling Input (1 = OK 0 = Bad)	bit		
		10061	60	Compressor 1 Cycling Input (1 = OK 0 = Bad)	bit		
		10065	64	Default Defrost Flag	bit		
		10066	65	Demand Defrost Fault C Flag	bit		
		10067	66	Demand Defrost Fault B Flag	bit		
		10068	67	Demand Defrost Fault A Flag	bit		
		10069	68	Fan Failure (1 = Failed 0 = Ok)	bit		
		10070	69	Heat Failure (1 = Open 0 = Closed)	bit		
		10071	70	HPC for Compressor 2 (1 = High Press 0 = Normal)	bit		
10072	71	HPC for Compressor 1 (1 = High Press 0 = Normal)	bit				
Analog Inputs	4	30001	0	Outdoor Air Temperature Sensor Value	Temperature		
		30002	1	Zone Temperature Sensor Value	Temperature		
		30003	2	Mixed Air Temperature Sensor Value	Temperature		
		30004	3	Return Air Temperature Sensor Value	Temperature		
		30005	4	Local Zone Cooling Setpoint Input	Temperature		
		30006	5	Local Zone Heating Setpoint Input	Temperature		
		30007	6	Actual Zone Cooling Setpoint	Temperature		
		30008	7	Actual Zone Heating Setpoint	Temperature		
		30009	8	Outdoor Air Relative Humidity Sensor Value ( 10.0 to 90.0 %)	Percentage		
		30010	9	Return Air Relative Humidity Sensor Value ( 10.0 to 90.0 %)	Percentage		
		30011	10	Local Economizer minimum position Range ( 0.0 to 50.0 %)	Percentage		
		30012	11	Actual Economizer Damper Position Range ( 0.0 to 100.0 %)	Percentage		
		30013	12	Number of Cooling Stages Active ( 0 to 3)	None		
		30014	13	Number of Heating Stages Active ( 0 to 3)	None		
		30016	15	Reference Enthalpy Switch Settings ( 22, 23, 25 or 27 BTU/LBM)	None		
		30018	17	Bit 0 Gas or Electric (1 = Gas Heat 0 = Electric Heat)			bitfield
				Bit 1 Heat Pump (Voyager I & II Only) (1 = Yes 0 = No)			
				Bit 2 Voyager III Unit (1 = Yes 0 = No)			
				Bit 3 Economizer Installed (1 = Installed 0 = Not Installed)			
				Bit 4 Gemini Unit (1 = Yes 0 = No)			
				Bit 5 Not Used - Reserved for UCP			
				Bit 6 Not Used - Reserved for UCP			
				Bit 7 Not Used - Reserved for UCP			
				Bit 0 Compressor On or Off (1 = On 0 = Off)			
				Bit 1 Compressor 1 Locked Out (1 = Yes 0 = No)			
				Bit 2 HPC for Compressor 1 (1 = High Press 0 = Normal)			
				Bit 3 Compressor 1 Cycling Input (1 = Normal 0 = Disabled)			
Bit 4 Compressor 1 Exists (1 = Yes 0 = No)							
Bit 5 Compressor 1 is Lead (1 = Yes 0 = No)							
Bit 6 Not Used - Reserved for UCP							
Bit 7 Not Used - Reserved for UCP							
30019	18	Bit 0 Compressor On or Off (1 = On 0 = Off)			bitfield		
		Bit 1 Compressor 1 Locked Out (1 = Yes 0 = No)					
		Bit 2 HPC for Compressor 1 (1 = High Press 0 = Normal)					
		Bit 3 Compressor 1 Cycling Input (1 = Normal 0 = Disabled)					
		Bit 4 Compressor 1 Exists (1 = Yes 0 = No)					
		Bit 5 Compressor 1 is Lead (1 = Yes 0 = No)					
		Bit 6 Not Used - Reserved for UCP					
		Bit 7 Not Used - Reserved for UCP					



# PIC Modbus

Table 28 - Continued

Data Type	Function	Modbus Index	Offset	Point Description	Unit
Analog Inputs	4	30020	19	Bit 0 Compressor On or Off (1 = On 0 = Off)	
				Bit 1 Compressor 2 Locked Out (1 = Yes 0 = No)	
				Bit 2 HPC for Compressor 2 (1 = High Press 0 = Normal)	
				Bit 3 Compressor 2 Cycling Input (1 = Normal 0 = Disabled)	
				Bit 4 Compressor 2 Exists (1 = Yes 0 = No)	
				Bit 5 Compressor 2 is Lead (1 = Yes 0 = No)	
				Bit 6 Not Used - Reserved for UCP	
				Bit 7 Not Used - Reserved for UCP	bitfield
		30021	20	Bit 0 Zone Temperature Sensor Failed (1 = Yes 0 = No)	
				Bit 1 Outdoor Air Temperature Sensor Failed (1 = Yes 0 = No)	
				Bit 2 Supply Air Temperature Sensor Failed (Mixed) (1 = Yes 0 = No)	
				Bit 3 Outdoor Humidity Sensor Failed (1 = Yes 0 = No)	
				Bit 4 Return Air Temperature Sensor Failed (1 = Yes 0 = No)	
				Bit 5 Return Humidity Sensor Failed (1 = Yes 0 = No)	
				Bit 6 Not Used - Reserved for UCP	
		Bit 7 External Auto Stop (1 = Yes 0 = No)	bitfield		
		30022	21	Bit 0 High Temperature Input is Hot / Smoke Detector (1 = Yes 0 = No)	
				Bit 1 Heat Failure (1 = Yes 0 = No)	
				Bit 2 Filter Clogged Failure (1 = Yes 0 = No)	
				Bit 3 Not Used - Reserved for UCP	
				Bit 4 Local Zone Heating Setpoint Failed (1 = Yes 0 = No)	
				Bit 5 Local Zone Cooling Setpoint Failed (1 = Yes 0 = No)	
				Bit 6 Coil Temperature Sensor Failed (1 = Yes 0 = No)	
				Bit 7 Economizer Fault (1 = Yes 0 = No)	bitfield
		30023	22	Bit 0 Spare	
				Bit 1 Supply Fan is Energized (1 = Yes 0 = No)	
				Bit 2 Reverse Valve is Energized (1 = Yes 0 = No)	
				Bit 3 Heat Output 2 is Energized (1 = Yes 0 = No)	
Bit 4 Heat Output 1 is Energized (1 = Yes 0 = No)					
Bit 5 Condenser Fan B is Energized (1 = Yes 0 = No)					
Bit 6 Condenser Fan A is Energized (1 = Yes 0 = No)					
Bit 7 Exhaust Fan is Energized (1 = Yes 0 = No)	bitfield				





## Notes

---



## Notes

---



## Notes

---



Trane optimizes the performance of homes and buildings around the world. A business of Ingersoll Rand, the leader in creating and sustaining safe, comfortable and energy efficient environments, Trane offers a broad portfolio of advanced controls and HVAC systems, comprehensive building services, and parts. For more information, visit [www.Trane.com](http://www.Trane.com).

Trane has a policy of continuous product and product data improvement and reserves the right to change design and specifications without notice.

© 2011 Trane All rights reserved  
CNT-SVX15D-E4 November 2011. Supersedes CNT-SVX15C-E4 June 2006



Digitally printed on environmentally friendly paper;  
produced using fewer trees and chemicals and less energy.

