



TRANE®

*Cooling and Heating
Systems and Services*

UniTrane™ FCD ducted fan coil units

**FCD 101-103-203-204-304-306-406-408-
508-512-612-616-716-724**

FED 100-200-300-400

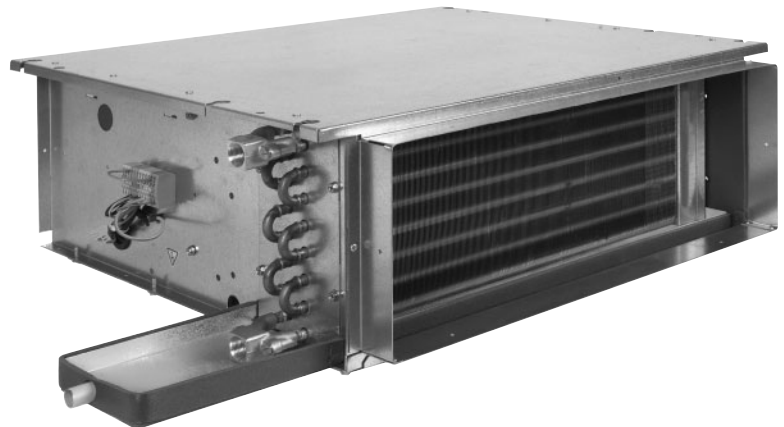

UNT-PRC012-E4



Contents

Introduction	4
Features and Benefits	7
Unit Description	12
Options	13
Accessories	26
General Data	30
Cooling Capacities - FCD	36
Cooling Capacities - FED	44
Heating Capacities - FCD	52
Heating Capacities - FED	56
External Static Pressure and Airflow Curves	60
Water Pressure Drop Curves	69
Sound Levels	74
Model Number	86

Introduction

The UniTrane™ FCD/FED unit is a horizontal ductable fan coil capable of air-conditioning areas between 20 and 90 m².

They are designed to fit demanding customer needs in terms of comfort in cooling and heating mode, sound levels, ease of installation and maintenance.

The model FCD is equipped with an AC fan motor. The model FED is equipped with an EC fan motor.

Comfort

The UniTrane™ FCD range is available in 7 physical casings - 1, 2, 3, 4, 5, 6 and 7. The FED range is available in 4 casings - 1, 2, 3, 4 (same as FCD casings). For each physical casing, four combinations of water coil and fan motor can be selected in order to match the exact cooling or heating capacity requirement.

As an option, a LonTalk controller can further improve the comfort of the occupant by optimizing the valve position and the fan speed selection. The room air and the discharge air temperatures are constantly monitored to avoid cold air drafts.

Sound level

More than ever the absence of noise is a key criterion for the selection of an air-conditioning system. That is the reason why Trane paid particular attention on the sound level during the development of the unit. Thus reducing by several dB the overall sound level of the unit compared to the previous range.

Thanks to an EC motor and the ZN control's continuous and variable speed control, the FED fan coil can achieve exceptionally low sound levels without perceivable shifts of fan speeds.

Ease of installation

Thanks to its low height and its compactness, the unit can be installed in most false ceilings. Except for the biggest casing, the dimension between the top of the unit and the bottom of the condensate drain pan outlet is constant (217mm), giving an immediate reading of the maximum length for the drainage by gravity. The new anchoring system allows the unit to be suspended with minimum 3 rods or directly fitted to the ceiling using a drill.

Matching a wide range of installation, the unit can be configured with multiple combinations of types, diameters and number of duct connections on the return air side as well as on the discharge air side.

Ease of maintenance

The access to the air filter is very easy and does not need any tool whatever the unit configuration.

The unit also includes a new system to remove/replace the fan motor + electric heater (option) assembly from the inside of the unit, reducing the number of ceiling tiles to remove.

Thanks to these above features, the UniTrane™ FCD/FED range is suitable for office building, hotel, store, shop and classroom applications.

Introduction

Typical installation

As a system, the UniTrane™ FCD/FED unit can be connected to a discharge air grille/diffuser and/or a return air grille/diffuser (supplied by Trane or by others) using thermally and acoustically insulated flexible ducting. The pre-treated and filtered fresh air coming from the air handling unit (supplied by Trane or by others) can be connected either to the inlet or to the outlet of the unit; the airflow rate can be controlled by a constant air flow module as an option. The chilled water or the hot water coming from the chiller (supplied by Trane or by others) is connected through a 2-way or a 3-way valve according to the hydraulic circuit installation. The control (supplied by Trane or by others) is managing the overall terminal unit or system.

Figure 1 - Typical installations

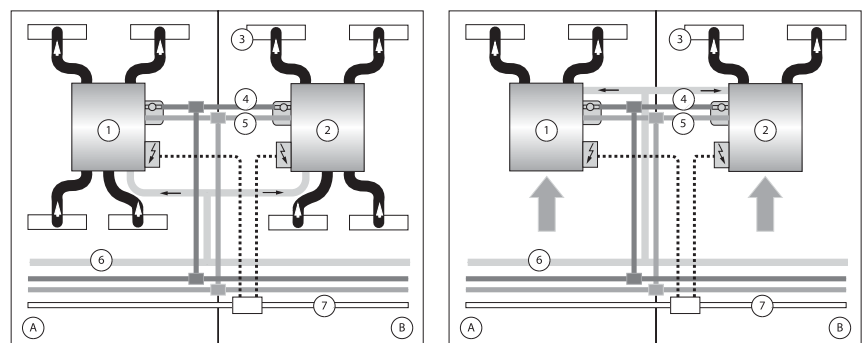

1. FCD/FED Left-hand
2. FCD/FED Right-hand
3. Diffuser
4. Supply
5. Return
6. Fresh air
7. Power supply
- A. Section 1
- B. Section 2

Introduction

A "Total Quality" Product

The Total Quality principle is based on the ISO 9001-certified Trane quality assurance system, and applies to all aspects of the product's operating life. All UniTrane™ FCD/FED units are manufactured under Trane quality standards, and all components are tested during assembly. Materials Management initiatives, like ISO 9001 help us develop an integrated supply chain process that provides mutual benefit to our customers, our suppliers, and our company as a whole.

Sound performance is tested in a 300m² reverberant sound laboratory compliant to ISO 3741 standards. It is capable of measuring sound power and inlet and outlet radiated sound, and of simulating real operating conditions in order to measure static pressure through ducts.

EUROVENT Certification



The airflow, capacities and sound levels of the units have been tested by an independent laboratory and are Eurovent certified in the Eurovent Certification Program for fan coil units, thus guaranteeing very precise performance data for the customer.

Safety

To make the installation of the product and its maintenance safer, all casings of the UniTrane™ FCD/FED range are manufactured without sharp edges (where possible). Nevertheless it is recommended to wear gloves when handling units and during the installation.

Environment

Trane manufacturing sites in Charmes and Golbey were certified ISO 14001 in July 2004. To reduce wastes on the job site, units are stacked on a pallet and covered with a recyclable film.

Features and Benefits

Unit Chassis

The unit chassis is made from one piece of 1.0mm thick hot dip galvanized sheet steel. It is thermally and acoustically-lined with a 5mm thick closed-cell polyethylene foam. This insulating foam is M1-certified fire retardant and its remarkable stability over time ensures that it does not emit particles into the airflow, thus giving a very quiet operation and keeping a good air quality.

All removable access panels are accessible from below the unit.

As an option, the unit can be equipped with a multi-outlet, multi-type air connection adaptor at the inlet or / and at the outlet.

Water Coils

UniTrane™ FCD/FED fan coils are equipped with high-performance water coils, which are factory tested at 21 bars, for a service pressure of up to 16 bars. They are made of aluminum fins mechanically crimped by expansion onto copper pipes diameter 3/8" (9.50 mm). The fins, WavyIII B-type, specially designed by Trane, allow a high heat transfer ratio. The maximum allowed entering water temperature is 95°C. The entering and leaving water connections are 1/2" ISO/R7 female type. The water coils feature air vents and drains as standard with easily accessible slotted/hexagonal plugs. They are easily accessible from underneath and are removable from underneath or from the side of the unit. The four types of coils available in the FCD/FED range are 2-pipe standard capacity, 2-pipe high capacity and 4-pipe.

- Cooling or heating with the 2-pipe standard capacity coil
- Cooling or heating with the 2-pipe high capacity coil allowing higher cooling or heating capacity for the same unit casing (option)

- Cooling and heating with the 4-pipe standard capacity coil (option)
- Cooling and heating with the 4-pipe high capacity coil allowing higher cooling and heating capacity for the same unit casing (option).

Figure 2 - 2-pipe straight coil



Figure 3 - 2-pipe inclined coil



Features and Benefits

FCD Fan Motor Assembly

The unit is equipped with a high efficiency, multi-speed quiet motor able to provide up to 80 Pa of external static pressure when both inlet and outlet air connection adaptors are installed. As a consequence, the ratio between the output cooling capacity and the power consumption is high.

These motors have a permanent split capacitor and are mounted on anti-vibration mountings. They are protected against overheating (a temperature sensor is inserted in the motor winding), have a Class IP21 protection and class B for insulation rating. The bearing mountings on the shaft do not necessitate any maintenance because they are lubricated for life and contribute to giving the motor a life span of 40,000 hours.

The motors drive double-air inlet fan wheels. All fan wheels are aluminum or plastic, multi-blade, centrifugal action-type, and statically-balanced.

A quick selection of three speeds among the six available speeds from the control panel permits a better adjustment of the airflow during the commissioning stage and, as a consequence, of the sound levels. Like water coils, the fan board is factory-tested at all fan speeds and a quick connector allows for connection to the control panel.

FED Fan Motor Assembly

Equipped with an ultra-efficient Electronic Commutated winding motor, the FED unit is capable of saving up to 65% energy consumption per year. The motor's electronic control is built into the motor frame in a sealed compartment resulting in an extraordinary integrated solution demonstrating the best of EC motor technology. The motor drives continuous variable speed through the entire operating range of the FED terminal and, when associated with the Trane ZN controller, the FED terminal will deliver the perfect cooling (or heating) capacity at all times without a perceivable shift in operating speed.

Condensate Tray

Keeping hygiene and security in mind, the units were designed with a condensate tray allowing for the evacuation of condensates coming from the water coil and the cooling valve. This tray minimizes the quantity of residual water inside the unit. It is a one-piece structure made of hot dip galvanized sheet steel, and insulated with polyethylene self-extinguishing foam (5mm thick, fire retardant CSTB M1), and has a 16mm external diameter outlet provided for the drainage. The evacuation of the condensates is assisted thanks to its position downward from the fan, in other words, in the high air pressure zone. This position avoids having foul air drawn through the system of condensate evacuation. The condensate tray is easily accessible and removable from underneath the unit, without disconnecting the ductwork and without putting the unit down.

Features and Benefits

Control Panel

The control panel is made of hot dip galvanized sheet steel and was designed to not only adapt to Trane on/off or electronic controls, but also to other controls on the market. Turning 1 screw gives easy access to the control panel with its quick connection terminal block for accurate commissioning of air volumes. It is built according to the standard CEI 335-2-40, its protection class of IP23 and maintains the full earth continuity.

The wiring diagram of the controls is provided with the unit. All factory-supplied and mounted controls (see options) are tested.

Figure 4 - Control panel



Features and Benefits

Unit Handling

The units are available in four different configurations to adapt to any job site configuration:

- Both water and electrical connections on the right or on the left side (when facing the airflow). This configuration permits to save the maximum space at the opposite side of the connections.
- The water connection on the right side and the electrical connection on the left side, or the reverse.

Unit Identification

Reducing the time spent on the job site to identify the right configuration, each unit arrives with an identification sticker with pictograms. Each pictogram clearly indicates important information such as the order number, the unit model & size, the coil type, the presence of an electric heater, the unit handling and the factory speed wiring. In addition to this standard information, customized tags can also be printed on the sticker to furthermore ease the unit identification and localization.

Units arrive on site with an identification sticker with pictograms, which clearly indicates important information such as the customer order number, job name, unit model size, coil type, presence of an electric heater, motor type, unit handling, speed wiring, and so on. (See Figure 5)



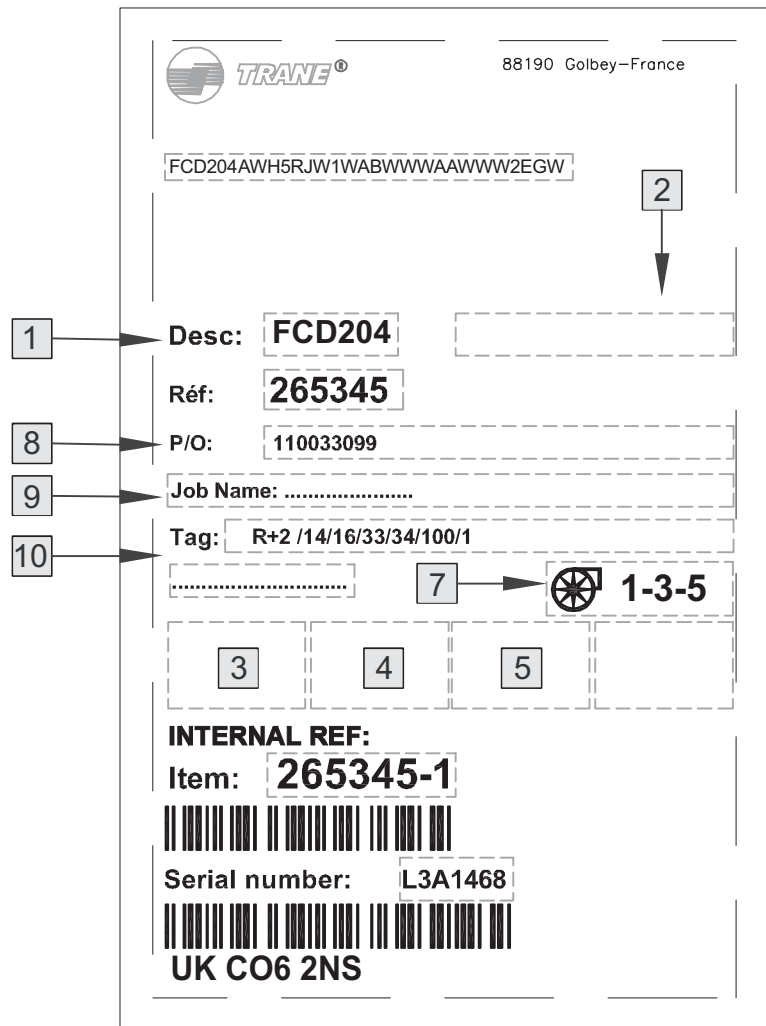





Figure 5 - Unit identification sticker







Features and Benefits

① = Indicates the unit description



② = Indicates the ZN control configuration program

2 	2-pipe cooling only	4	4-pipe
2 	2-pipe heating only		Zone control
2 	2-pipe cooling + electric heater		Cascade control
2 	2-pipe changeover, 2-way valve		
2 	2-pipe changeover, 3-way valve		
2 	2-pipe changeover + electric heater, 2-way valve		
2 	2-pipe changeover + electric heater, 3-way valve		





③ = Indicates the unit handing

	Water Right hand + Electric Right connection
	Water Left hand + Electric Right connection
	Water Right hand + Electric Left connection
	Water Left hand + Electric Left connection

⑤ = Indicates the presence of an electric heater

	Electric heater. If nothing, no electric heater
	Electric heater with electro-mechanical relay
	Electric heater with solid-state relay

④ = Indicates the coil type

	Standard coil
	2-pipe high capacity coil
	4-pipe standard coil
	4-pipe high capacity coil

⑦ = Indicates the factory-wired fan speeds (AC motor) or presence of EC motor

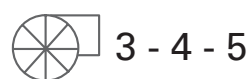
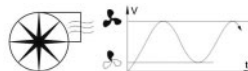
	3 = Low speed 4 = Medium speed 5 = High speed
	Indicates presence of EC motor

⑧ = Indicates customer order number (max 25 alphanumeric characters)

⑨ = Indicates job name (max 25 alphanumeric characters)

⑩ = Indicates personal customer tag (max 22 alphanumeric characters)

Unit description

Figure 6 - Unit view from the top

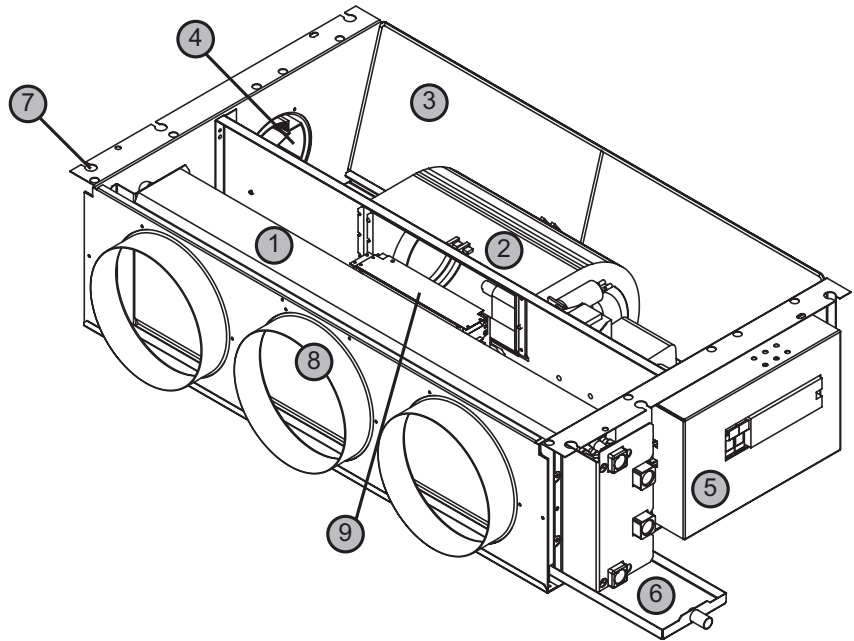





- 1 Chilled water coil, Hot water coil (Option)
- 2 Fan
- 3 Air filter (Option)
- 4 Fresh air inlet spigot (factory mounted option or accessory) - \varnothing 100mm or 125mm - with or without fresh air controller
- 5 Control box
- 6 Drain Pan
- 7 Anchoring clips and rubber insulators
- 8 Discharge Spigots (\varnothing 200mm or 150 mm) - Quantity differs according to unit size
- 9 Electric heater (Option)

Options

Inlet and outlet air duct connections

In order to suit different types of installations, UniTrane™ FCD/FED units are available with different numbers, types and diameters of duct connections. The following table shows what the different possibilities are.





Table 1 - Air ducts dimension and numbers - FCD

	101	103	203	204	304	306	406	408	508	512	612	616	716	724
Circular connection ø 160 mm 	1 or 2	2	2	2	2 or 3	3	3 or 4	4	4 or 5	5	5 or 6	6	6	-
Circular connection ø 200 mm 	1	1	1 or 2	1 or 2	1 or 2	2 or 3	2 or 3	2 or 3	2 or 3	3 or 4	3 or 4	4 or 5	4 or 5	5
Oblong connection, equivalent ø 250 mm 	1	1	1	1	1 or 2	1 or 2	1 or 2	2	2 or 3	2 or 3	2 or 3	3 or 4	3 or 4	3 or 4
Rectangular connection (39 mm deep) 	194 x 418 mm		194 x 568 mm		194 x 798 mm		194 x 948 mm		194 x 1098 mm		194 x 1398 mm		238 x 1398 mm	
Rectangular connection for Trane discharge grille (80 mm deep) 	152 x 403 mm		152 x 503 mm		152 x 803 mm		-		-		-		-	

Spigots that may not be used must be sealed on job site with a spigot cap or equivalent.
 Note: Trane do not recommend an air velocity per duct connection above 3 to 4 m/s.

Options

Table 2 - Air ducts dimension and numbers - FED

	FED 100	FED 200	FED 300	FED 400
Circular connection ø 160 mm 	1 or 2	2	2 or 3	3 or 4
Circular connection ø 200 mm 	1	1 or 2	2 or 3	2 or 3
Oblong connection, equivalent ø 250 mm 	1	1	1 or 2	1 or 2
Rectangular connection (39 mm deep) 	194 x 418 mm	194 x 568 mm	194 x 798 mm	194 x 948 mm
Rectangular connection for Trane discharge grille (80 mm deep) 	152 x 403 mm	152 x 503 mm	152 x 803 mm	-

Spigots that may not be used must be sealed on job site with a spigot cap or equivalent.
 Note: Trane do not recommend an air velocity per duct connection above 3 to 4 m/s.

Options

Air Filter

The unit can be factory-equipped with a cleanable G3 filter (85% gravimetric efficiency), made of a 8mm-thick polyester media mounted on a metallic frame. It is M1-certified fire retardant, is easily removable without any tool from the back or from underneath according to the configuration of the unit and contribute to maintain a good air quality level within the air-conditioned space.

As an option, it is also possible to order the unit without any air filter. In this case, it is recommended to use a return air grille equipped with a filter.

Fresh Air Inlet

It is possible to equip the unit with a fresh air connection (\varnothing 100 mm or \varnothing 125mm). The connection can be located at the inlet (opposite side of the control panel) or at the outlet (right or left hand side) of the unit. Moreover, a fresh air flow controller module can be installed inside the fresh air connection. The module ensures a constant fresh air flow from the air handling unit to be mixed with the circulated air to ensure a hygienic renewal of air in the room. Its choice depends on the volume of the room to air-condition.

Several possibilities are available:

- Duct connection \varnothing 100mm only (no fresh air flow controller)
- Duct \varnothing 100mm + a 30m³/hr fixed fresh air flow controller (-10/+20%)
- Duct \varnothing 100mm + a 45m³/hr fixed fresh air flow controller (-10/+20%)
- Duct connection \varnothing 125mm only (no fresh air flow controller)
- Duct \varnothing 125mm + an 60-130m³/hr adjustable fresh air flow controller (-10/+20%)

Static pressure range: for 50 to 200 Pa

Note: In all cases, the fresh air connection must be connected to a filtered and pre-treated air supply (e.g. air handling unit).

Options

Figure 7 - Fresh air inlet with the adjustable airflow controller

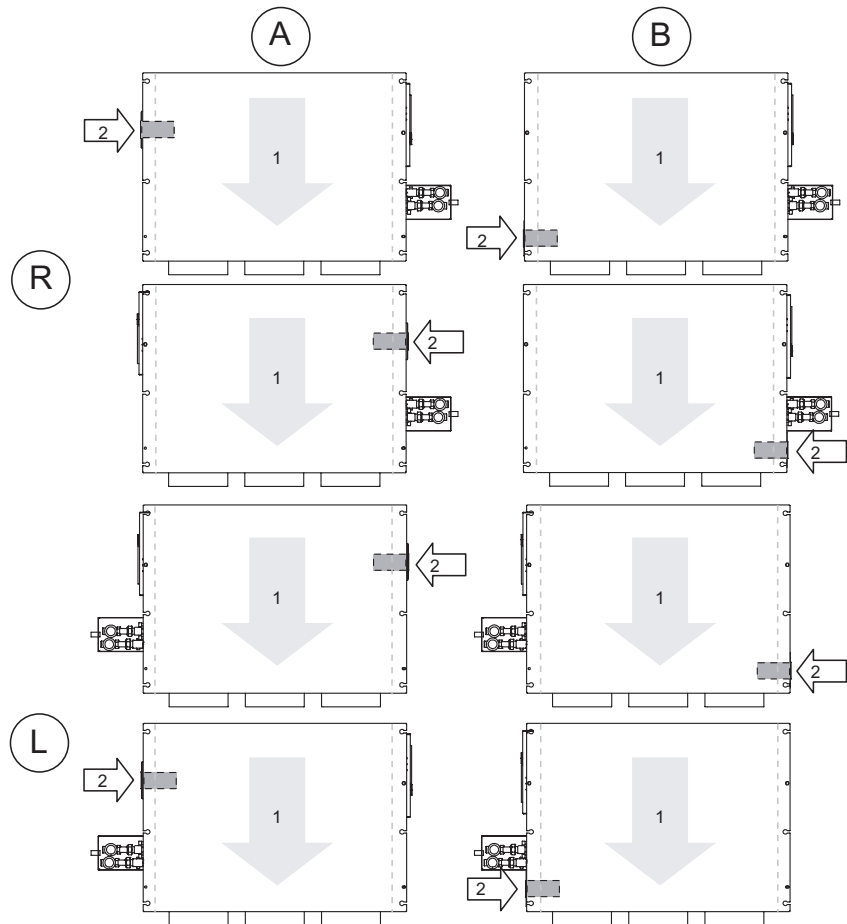

- A = Fresh air duct placed at air intake
- B = Fresh air duct placed at air discharge
- L = Left hand configuration
- R = Right hand configuration
- 1 = Airflow
- 2 = Fresh air intake possibility, in compliance with unit size and configuration

Options

Figure 8 - Fresh air inlet with the adjustable airflow controller



Adjustment of the 60-130m³/hr fresh air flow controller

The setting of the 60-130m³/hr fresh air flow controller is easy to modify on the job site. By moving the two side baffles, it is possible to adjust the airflow at four different values: 60, 75, 90 or 130m³/h (Maximum constant airflow).

Electric heater

The electric heater is made of bare wire resistive elements which have an excellent heat transfer characteristic. As they exhibit very low residual heat retention, there is no need for the fan to run on after switching off the electric heater.

Heating elements are factory-mounted inside the unit directly at fan air discharge ahead of the water coil. Several capacities are available for each unit size, from 0.5kW to 4.0kW for the largest unit size (see general data table). This allows for use as either additional heating or as the principal heating source; and allows for the adjustment of the heating capacity to the exact capacity need.

Each heating elements are equipped with two safety devices as standard: one automatic reset overheat thermostat (trip-off temperature 60°C) and one thermal fuse (trip-off temperature 110°C). When the thermal fuse has tripped-off, the heating element has to be changed.

Note: If the electric heater is managed by a controller supplied by others, it is mandatory to lock it if the fan is switched off.

Options

Figure 9 - Electric heater - FCD/FED

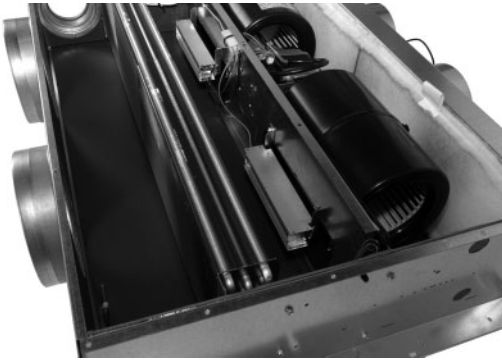

Table 3 - Minimum airflow (m³/h) in order to not damage heating elements - FCD

	Unit size	101	103	203	204	304	306	406	408	508	512	612	616	716	724
Heating capacity	500W		100	100	80	80	80	80							
	750W			150	120	120	120	120							
	1000W				160	160	160	160							
	1500W					240	240	240	190	190	265	265	285	285	375
	2000W						320	320	250	250	350	350	380	380	500
	3000W								375	375	525	525	565	565	750
	4000W									500	700	700	755	755	1000

Table 4 - Minimum airflow (m³/h) in order to not damage heating elements - FED

	Unit size	100	200	300	400
Heating capacity	500W	80	80	80	
	750W		120	120	
	1000W		160	160	160
	1500W			240	240
	2000W			320	320
	3000W				480

Note: 0-10V signal for motor operating range is reduced in heating mode versus cooling mode in order to keep the airflow above the minimum heater operating range

Options

Condensate pump

As an option, units can be supplied with a factory-mounted, quiet operation condensate pump. The pump is fitted beside the condensate tray, and can afford a maximum pump height of 6m.

The condensate pump is equipped with a floating sensor which will stop the chilled water flow in the water coil as soon as the alarm level is reached, while continuing to evacuate condensate water. The condensate pump option is increasing the height of the unit by 20 mm. As the alarm contact is a voltage-free contact, it can be also used for other purposes (information to a person from the maintenance).

Condensate pump 1 (for on/off controls):

Power supply: 230V/50Hz/1Ph
 Max flow rate (+/- 10%) : 8 l/h
 Sound level (at 1m distance) : < 28dBA
 Alarm contact: Relay NC, 250V 8A resistive

Nominal input power: 6W (max 10W)
 Max recommended discharge height : 6m
 Fluid temperature: 0°C to 35°C (condensate water)
 CE or UL std 778 certified

Condensate pump 2 (for ZN control):

Power supply: 230V/50Hz/1Ph
 Max flow rate (+/- 10%) : 10 l/h
 Sound level (at 1m distance) : < 21dBA

Nominal input power: 19VA
 Max recommended discharge height : 6m
 Fluid temperature: 0°C to 35°C (condensate water)

Alarm contact: Relay NC & NO, 250V 5A resistive NF EN 60 950; 70/23/CEE; 89/336/CEE

Condensate pump sensor:

'Start' level: 10 to 15 mm
 'Stop' level: 10 mm
 'Alarm' level: 17 mm

Figure 10 - Condensate pump on unit without ZN control

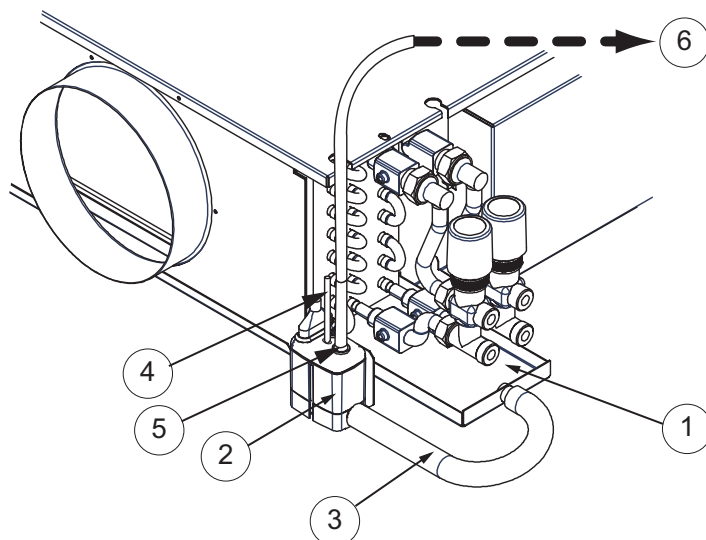

- 1= Condensate tray
- 2 = Condensate pump
- 3 = Condensate pump suction
- 4 = Vent
- 5 = Condensate pump discharge
- 6 = Towards condensate evacuation

Options

Figure 11 - Condensate pump on unit with ZN control

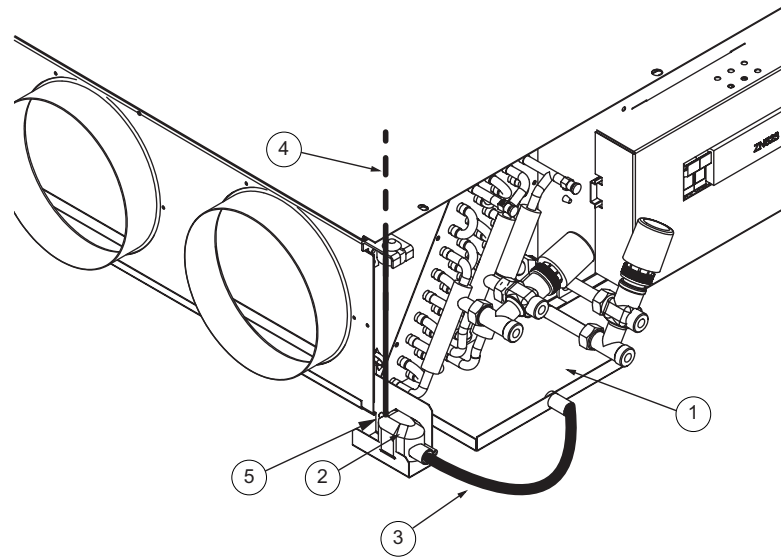

- 1 = Condensate tray
- 2 = Condensate pump
- 3 = Condensate pump suction
- 4 = Condensate pump discharge
- 5 = Vent

Table 5 - Condensate pump performances (l/h)

Pump	Discharge height - H	Discharge length - L			
		5m	10m	20m	30m
1	1 m	9.5	9.0	8.2	7.4
1	2 m	7.0	6.5	5.7	4.9
1	3 m	5.0	4.6	3.9	3.4
1	4 m	4.0	3.6	3.1	2.8
2	1 m	10	9.5	8	7
2	2 m	9	8	7	6
2	3 m	8	7	6	5
2	4 m	6.5	5	4	4

Options

Epoxy coating

The epoxy coating option is recommended when the unit has to be installed in an aggressive/corrosive atmosphere (areas with chemical industries, close to the sea, etc...). This option improves the life span of the water coil by having a specific coating on the aluminum fins.

Fan speed selection - FCD

As an option, it is possible to factory set the three speeds of the fan motor according to your needs and application. The fan speeds can be selected directly from the multi-position terminal block or from the quick connector in the control panel; this allows to have an accurate commissioning of air volumes.

Fan speed selection - FED

The fan motor speed is controlled via a 0-10V signal. The operating signal voltage range of the motor is specific to each unit size, as shown in Table 6. In between the minimum and maximum 0-10v signal, the motor will run any speed proportional to the command signal.

The heating mode signal voltage range is reduced for units equipped with an electric heater to not fall below the minimum operating airflow and to avoid tripping on overheat safety thermostats. This is reduced by using a higher minimum signal voltage value based on heater capacity watts.

Unit fuse

The fuse is optional with all on/off controls and delivered as standard with all modulating and communicating controls. If the unit is fitted with an electric heater, two fuses will be provided otherwise a single fuse protects the entire unit. Table 4 shows the fuse size depending on the unit configuration.

Table 6 - Fuse size (A) - FCD/FED

	Without electric heater	With electric heater < 2 kW	With electric heater > 2 kW
On/off controls	4	16	25
ZN control	4	10	25

Options

Valve package

Valve package options are factory-mounted and leak-tested at 6 bars. Depending on the application, a 2-way or a 3-way/4-port valve is available, and an on/off or a modulating valve can be chosen.

Figure 12 - Valve package

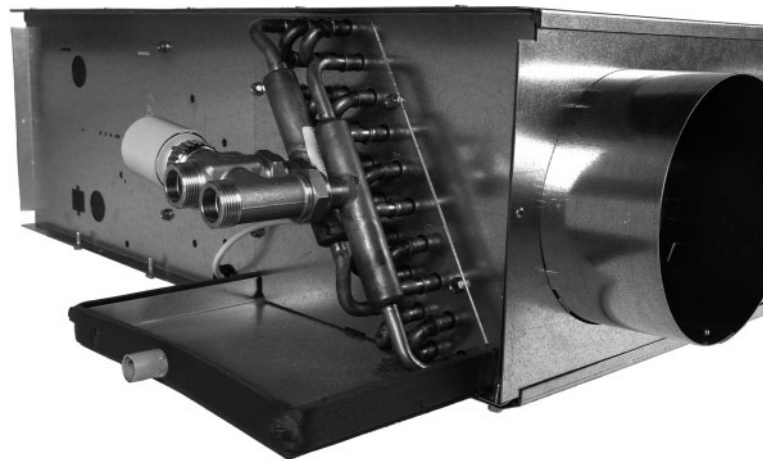

Actuators

Hot wax actuator - (compatible with Trane on/off wall thermostats)

Power supply: 230 VAC
(±10%)/50Hz/1Ph

Initial current: 0.7 A

Permanent current: 0.013 A

Power: 3 W

Maximum stroke: 2.5 mm

Ambient temperature: 0-50°C

Protection standard:

- IP43 for vertical installations, actuator pointing upwards
- IP40 for horizontal installations

Opening time: 4 min.

Closing time: 4-6 min. depending on heating time

Options

Modulating actuator (hot wax or 3 floating point) (compatible with Trane ZN control)

Power supply: 230 VAC
(±10%)/50Hz/1Ph

Power: 3W

Maximum stroke: 6.5 mm

Protection standard:

- IP43 for vertical installations, actuator pointing upwards.
- IP40 for horizontal installations.

Ambient temperature: 0-50°C

Permanent current: 0.125A

Valve bodies

On/Off 2-way and 3-way/4port valve

Action: Normally closed

Water temperature: 2-120°C

Suitable medium: Water, with maximum 50% glycol

Static pressure: 16 bar, PN 16

Connection diameter: 1/2" & 3/4", flat faced

Valve capacity:

(Cooling and heating, 2-way) kv = 1.0, 1.6 or 2.5

(Cooling and heating, 3-way/4port) kv = 1.0, 1.6 or 2.5
(direct way), cv = 0.63, 1.0 or 1.6
(bypass)

Differential pressure: 180 kPa (2-way), 150 kPa (3-way/4port)

Maximum stroke: 2.5 mm

Flow characteristic: Equal percentage

Body: nickel-plated brass

2-way and 3-way / 4-port modulating valve

Action: Normally closed

Water temperature: 2-120°C

Suitable medium: Water, with maximum 50% glycol

Static pressure: 16 bar, PN16

Connection diameter: 1/2" & 3/4", flat faced

Valve capacity:

(Cooling and heating, 2-way) kv = 1.0, 1.6 or 2.5

(Cooling and heating, 3-way/4port) kv = 1.0, 1.6 or 2.5
(direct way), cv = 0.63, 1.0 or 1.6
(bypass)

Differential pressure: 180 kPa (2-way), 150 kPa (3-way/4port)

Maximum stroke: 6.5 mm

Flow characteristic: Equal percentage

Body: brass

Options

On/off controls

Different wall mounted control packages selected to match the designated valve package are available. Each system is customised to the customer requirements and provides room air thermostats, motor speed control switch, summer/winter switch, electric heater command and overheat protection thermostat (according to the unit configuration).

Unit mounted terminal strip is provided for customers supply voltage wiring. All controls are factory-tested. The following unit configurations are supported:

- 2-pipe cooling
- 2-pipe cooling + electric heater
- 2-pipe changeover + electric heater
- 2-pipe heating
- 2-pipe changeover (manual or automatic)
- 4-pipe

Two specific controls have been developed for a 2-pipe changeover + electric heater application with a pilot relay.

- In the first case, the management of the electric heater is centralized meaning that the pilot relay (230V) is energized by a central system when the electric heater is authorized to operate.
- In the second case, the management is local meaning that the local changeover sensor is locking the electric heater if the hot water coil is sensed in the entering pipe.

Note: For more details about on/off valves, refer to the manual CNTSVX14B.

Intelligent LonTalk (ZN) control

The Tracer™ ZN unit controller is an open protocol, micro-processor based direct digital controller that is dedicated to the control and the optimisation of the fan coil units. The 'Zone' version includes a single control loop and provides already a high level of comfort. The 'Cascade' version includes a double control loop and provides an improved comfort level with a minimum energy consumption through the use of custom proportional integral derivative (PID) control algorithms as well as intelligent fan speed and set point control strategies. The 'Cascade' algorithm keeps supply air temperature from falling below 14°C when associated with modulating valves, eliminating the risk of cold air drafts. An optional supply air temperature sensor is required to achieve this function. It is factory installed, pre-commissioned and tested, resulting in a highly integrated product, reduced installation and commissioning time. A modulating valve using a hot wax actuator or a 3 floating point actuator can be connected to the controller.

The following configurations are supported by the controller:

- 2-pipe cooling
- 2-pipe cooling + electric heater
- 2-pipe changeover + electric heater
- 2-pipe heating
- 2-pipe changeover (manual or automatic)
- 4-pipe

Table 7 - ZN preferred control configurations

	Hot Wax	3 Wire
Zone	X	X
Cascade	-	X

Options

Two options are possible when the unit is fitted with an electric heater option, the cost efficient one is based on a low noise electro-mechanical relay, the comfort one is based on a solid state relay that can modulate the capacity of the electric heater without any noise.

The intelligent control offers the following benefits:

- Built-in electrical protection
- Adjustable local set point max - min limits
- Intelligent management of valve position and fan speeds. Valve must be fully open before changing the fan speed (acoustic comfort optimization)
- Control algorithms based on ambient and discharge air temperatures
- Discharge air temperature (low and high limit control)
- Automatic changeover based on ambient air - entering water temperatures differential (+/- 2.5K)
- Automatic stand-alone changeover (2-way or 3-way valve)
- 2 operating modes in stand-alone application: comfort and reduce

- Built-in adjustable timed override function
- After a power up in the building, units automatically staggered from 5-32 seconds
- Built-in condensate overflow protection
- Built-in output test capability
- Built-in diagnostic indicator

The ZN control is compatible with a full range of wall sensors, including an infra-red version.

Note: For more details about the LonTalk ZN control, please refer to the manual BAS-SVX02A (ZN525) / BAS-SVX003 (ZN523).

Free issued controls

In addition to Trane's proposed controls, free issued controls and valves by the customer can be factory fitted and wired. Please refer to your local Sales Office for more details.

Empty Control Box

When the control is going to be fitted on site, an empty control box can be ordered. It is designed to receive major controls on the market. It includes a fan speed motor and mains power supply terminal blocks and a metal cover.

Inside dimensions (mm): 280 X 185

Water coil, fan motor access

Thanks to this option, it is very easy to remove the water coil or the fan motor assembly. A system allows for simple removal of these parts from the inside of the unit, thus reducing the number of ceiling tiles to remove.

Flexible hose pipes

Flexible connection hoses are used to connect the unit to the installation. Two insulated hoses are supplied per circuit. Two for a 2-pipe system, and four for a 4-pipe system. The flexible connection hoses are shipped with each unit, but are not factory-mounted. They are guaranteed for ten years. According to the unit size, bent 1/2" ISO R7 gas male-female, 400mm long and/or straight 3/4" ISO R7 gas male-female, 500mm long non-insulated flexible connection hoses are provided.

Figure 13 - Flexible 1/2" hose pipes



Accessories

On/off wall thermostats - FCD

Five models of wall mounted switch / thermostats are available - two models for fan control only, and three models for the control of thermal valves and/or electric heater option:

- Remote fan switch (L): This device is used to control the three fan speed of the unit only.
- Remote, wall thermostat (M): This thermostat is used to control the fan either in cooling or heating mode.
- Remote, wall thermostat (N): This thermostat is used to control one or two on/off valve(s) or one on/off valve + an electric heater. The fan is running continuously. The changeover between the summer and the winter mode is manual.
- Remote, wall thermostat (P & E): These thermostats are used to control one or two on/off valve(s) or one on/off valve + an electric heater. The fan is running continuously. The changeover between the summer and the winter mode is automatic.

Thermostats - FED

Contact for local sales office for information.

Table 8 - Thermostat descriptions

Features	Fan switch 'L'	Wall Thermostat 'M'	Wall Thermostat 'N'	Wall Thermostat 'P'	Wall Thermostat 'E'
On/off switch	X	X	X	X	X
Manual 3 speed fan switch	X	X	X	X	X
1 stage thermostat + summer/winter switch		X	X		
2 stage thermostat (auto changeover)				X	X

Accessories

Applications (FCD only)	Fan switch 'L'	Wall Thermostat 'M'	Wall Thermostat 'N'	Wall Thermostat 'P'	Wall Thermostat 'E'
2-pipe cooling	Fan only	Fan only	Yes, fan runs continuously	Yes, fan runs continuously	Yes, fan runs continuously
2-pipe heating	Fan only	Fan only	Yes, fan runs continuously	Yes, fan runs continuously	Yes, fan runs continuously
2-pipe cooling + electric heater			Yes, fan runs continuously	Yes, fan runs continuously	Yes, fan runs continuously
2-pipe changeover (manual)	Fan only	Fan only	Yes, fan runs continuously		
2-pipe changeover (automatic)	Fan only	Fan only		Yes, fan runs continuously	Yes, fan runs continuously
2-pipe changeover + electric heater (automatic)				Yes, fan runs continuously	
4-pipe	Fan only	Fan only	Yes, fan runs continuously	Yes, fan runs continuously	Yes, fan runs continuously

Figure 14 - Thermostat type L, M/N, and P



Figure 15 - Thermostat type E

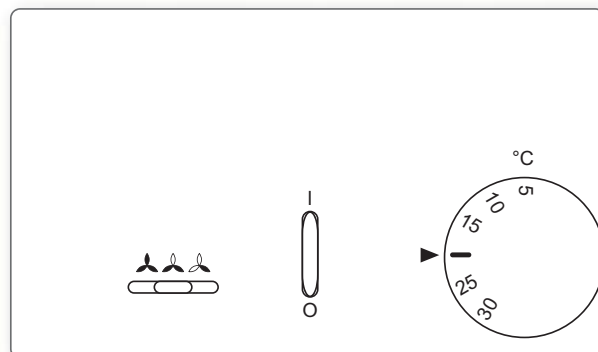

The recommended cable size is 1mm.

For more information about wiring, refer to the wiring diagrams.

Accessories

Fresh Air Controllers

The fresh air controller (see description in Options section) is also available as a site-installed accessory. Five possibilities are available as a kit:

- Duct connection \varnothing 100mm only (no fresh air flow controller)
- Duct \varnothing 100mm + a 30m³/hr fixed fresh air flow controller (-10/+20%)
- Duct \varnothing 100mm + a 45m³/hr fixed fresh air flow controller (-10/+20%)
- Duct connection \varnothing 125mm only (no fresh air flow controller)
- Duct \varnothing 125mm + an 60-130m³/hr adjustable fresh air flow controller (-10/+20%)

FCD/FED units have pre-punched holes (\varnothing 125 mm) at the air inlet and the air outlet. These holes can be used if a fresh air connection needs to be added on the job site. In this case, it is necessary to cut the insulation that is behind the metallic part held by four pins. A kit based on one of these above possibilities can then be installed.

Rubber isolators

A set of 4 pieces can be ordered with the unit. These rubber isolators reduce potential vibrations and avoid creating unexpected noise.

Accessories

Discharge air grilles

It is made of aluminum and allows good air diffusion while keeping allow sound level within the room. The discharge air grille can be connected directly to the unit when the wall is 50 mm wide.

Discharge air grilles are delivered separately.

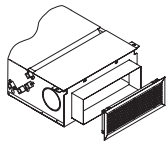

Three sizes are available (L x h):

- 400 x 150 mm (unit size 101-103, kit reference 3516 8754-002)
- 500 x 150 mm (unit size 203-204, kit reference 3516 8754-005)
- 800 x 150 mm (unit size 304-306; kit reference 3516 8754-004)

Straight discharge air duct connection for discharge air grilles

The discharge air duct is used to connect the unit to the discharge air grille through a wall (max 200 mm).

It is made of galvanized steel.

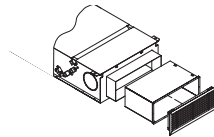

Three sizes are available (L x h):

- 400 x 150 mm (unit size 101-103, kit reference 3530 0573-001)
- 500 x 150 mm (unit size 203-204, kit reference 3530 0574-001)
- 800 x 150 mm (unit size 304-306; kit reference 3530 0575-001)

Discharge air ducts are delivered separately and have to be assembled and insulated on job site.

Condensate pump kit

A condensate pump can be installed on the job site. The kit includes the same components as for the condensate pump 2 option and as a consequence the same features.

With a ZN controller, the optional condensate pump kit can be factory-mounted.

Valve connection kit

When the water valve is supplied by others, this kit allows connecting the valve to the unit using copper elbows. It is compatible with the majority of 2-way and 3-way/4-port water valves of the market (symmetric configuration). It is necessary only with the straight water coil.

Conical connection kit

This kit allows connecting the unit to the hydraulic circuit using a conical connection instead of a flat faced connection.

Spare EU3 filter

A spare filter can be ordered with a unit and will replace the one delivered with the unit after the start up of the installation.

It is the same filter that can be ordered as an option (G3, 85% gravimetric efficiency)

Table 9 - Discharge air grilles data

Airflow (m ³ /h)		L x h (mm)		
		400 x 150	500 x 150	800 x 150
300	Noise rating NR			
	Pressure drop (Pa)			
400	Noise rating NR	23	<20	
	Pressure drop (Pa)	7	4	
600	Noise rating NR	33	28	< 20
	Pressure drop (Pa)	17	10	4
800	Noise rating NR	40	35	25
	Pressure drop (Pa)	30	18	7
1000	Noise rating NR	46	41	31
	Pressure drop (Pa)	46	29	11
1400	Noise rating NR	46		
	Pressure drop (Pa)	39		

General data

Table 10 - General Data - FCD without air connection

230V/50Hz/1ph, medium speed, 2 pipe, Eurovent program FC, 0 Pa

Unit size		101	103	203	204	304	306	406	408	508	512	612	616	716	724
Speed at ESP = 0 Pa		3	3	3	3	3	3	3	3	3	3	3	3	3	3
Airflow	(m ³ /h)	110	189	222	327	329	502	518	794	799	1033	1108	1571	1553	2053
Standard coil, cooling mode		Air inlet conditions : 27°C/50%, Water : 7/12°C Constant delta T°													
Total capacity	(kW)	0.9	1.3	1.3	1.8	2.2	3.1	3.5	4.8	4.0	4.7	7.5	9.5	9.1	11.2
Sensible capacity	(kW)	0.6	1.0	1.0	1.4	1.6	2.3	2.6	3.6	3.1	3.7	5.5	7.1	6.8	8.6
Water flow	(l/h)	148	225	226	306	381	533	607	819	696	818	1290	1634	1575	1935
Water pressure drop	(kPa)	8	16	4	7	8	16	19	33	32	43	30	46	29	43
Water content	(l)	0.5	0.5	0.6	0.6	1.3	1.3	1.5	1.5	1.5	1.5	2.8	2.8	3.3	3.3
Water connections		1/2" ISO R7 female gas							3/4" ISO R7 female gas						
Standard coil, heating mode		Air inlet : 20°C, water inlet : 50°C, Water flow from cooling mode													
Total capacity	(kW)	1.0	1.5	1.7	2.3	2.8	4.0	4.3	6.1	5.3	6.5	8.4	11.0	11.5	14.3
Water flow	(l/h)	148	225	226	306	381	533	607	819	696	818	1290	1634	1575	1935
Water pressure drop	(kPa)	6	13	3	6	7	14	15	27	27	36	26	40	27	40
Electric heater															
Minimum electric heater capacity	(W)	-	500	500	500	500	500	500	1500	1500	1500	1500	1500	1500	1500
Absorbed current at minimum capacity	(A)	-	2.2	2.2	2.2	2.2	2.2	2.2	6.5	6.5	6.5	6.5	6.5	6.5	6.5
Maximum electric heater capacity	(W)	-	500	750	1000	1500	1500	1500	3000	4000	4000	4000	4000	4000	4000
Absorbed current at maximum capacity	(A)	-	2.2	3.3	4.3	6.5	6.5	6.5	13.0	17.4	17.4	17.4	17.4	17.4	17.4
Fan motor															
Absorbed Power	(W)	16	25	26	34	34	58	59	87	87	139	145	189	187	294
Maximum external static pressure	(Pa)	40	60	60	60	90	90	90	90	90	90	90	90	90	90
Sound levels															
Sound power level (1)	(dB(A))	33	47	47	49	48	53	56	55	56	59	59	63	60	65
Sound pressure level (2)	(dB(A))	24	38	38	40	39	44	47	46	47	50	50	54	51	56
NC levels (2)		15	33	33	35	32	39	41	38	41	44	41	47	44	49
NR levels (2)		17	34	34	37	34	41	43	40	43	45	43	49	45	51

(1) Levels according to Eurovent specification 8/2 (ISO 3741/88) and Eurovent FC Certification

(2) Values calculated from sound power levels with a hypothetical acoustic attenuation of 9 dB.

(3) Levels according to Eurovent specification 8/2 (ISO 3741/88) and Eurovent FCP Certification

(4) Values calculated from sound power levels with a hypothetical acoustic attenuation of 20 dB.

General Data

Table 11 - General Data - FED without air connection

230V/50Hz/1ph, medium speed, 2 pipe, Eurovent program FC, 0 Pa

	Unit size	100	200	300	400
Speed at ESP = 0 Pa		3	3	3	3
Airflow	(m ³ /h)	204	306	432	635
Voltage	(V)	3.2	3.7	4.6	4.1
Water connections		1/2" ISO R7 female gas			
Standard coil, cooling mode		Air inlet conditions : 27°C/50%, Water : 7/12°C Constant delta T°			
Total capacity	(kW)	1.2	1.6	2.8	4.2
Sensible capacity	(kW)	0.8	1.2	1.9	2.9
Water flow	(l/h)	203	280	486	719
Water pressure drop	(kPa)	13	6	12	26
Water content	(l)	0.5	0.6	1.3	1.5
Standard coil, heating mode		Air inlet : 20°C, water inlet : 50°C, Water flow from cooling mode			
Total capacity	(kW)	1.4	2.0	3.3	4.8
Water flow	(l/h)	203	280	486	719
Water pressure drop	(kPa)	11	5	10	21
Electric heater					
Minimum electric heater capacity	(W)	500	500	500	1000
Absorbed current at minimum capacity	(A)	2.2	2.2	2.2	4.3
Maximum electric heater capacity	(W)	500	1000	2000	3000
Absorbed current at maximum capacity	(A)	2.2	4.3	8.7	13.0
Fan motor					
Absorbed Power	(W)	6	9	18	23
Maximum external static pressure	(Pa)	50	60	90	90
Sound levels					
Sound power level (1)	(dB(A))	41	45	52	53
Sound pressure level (2)	(dB(A))	32	36	43	44
NC levels (2)		27	30	37	39
NR levels (2)		28	31	38	40
Voltage range					
Minimum voltage	(V)	2	2.3	2.6	2.5
Maximum voltage	(V)	5.1	5.8	7.6	6.7

- (1) Levels according to Eurovent specification 8/2 (ISO 3741/88) and Eurovent FC Certification
 (2) Values calculated from sound power levels with a hypothetical acoustic attenuation of 9 dB.
 (3) Levels according to Eurovent specification 8/2 (ISO 3741/88) and Eurovent FCP Certification
 (4) Values calculated from sound power levels with a hypothetical acoustic attenuation of 20 dB.

General Data

Table 12 - General Data - FCD with inlet and discharge air connections

230V/50Hz/1ph, medium speed, 2 pipe, Eurovent program FC, 50 Pa

Unit size		101	103	203	204	304	306	406	408	508	512	612	616	716	724
Speed at ESP = 50 Pa		-	5	5	5	5	5	5	5	5	5	5	5	5	5
Airflow	(m ³ /h)	-	65	81	174	187	402	400	544	585	864	869	1184	1237	1911
Water content	(l)	-	0.5	0.6	0.6	1.3	1.3	1.5	1.5	1.5	1.5	2.8	2.8	3.3	3.3
Water connections					1/2" ISO R7 female gas						3/4" ISO R7 female gas				
Standard coil, cooling mode		Air inlet conditions : 27°C/19°C, Water : 7/12°C Constant delta T°													
Total capacity	(kW)	-	0.6	0.6	1.1	1.3	2.6	2.9	3.7	3.3	4.3	6.3	7.8	7.7	10.7
Sensible capacity	(kW)	-	0.4	0.5	0.9	1.0	2.0	2.1	2.7	2.4	3.3	4.5	5.8	5.6	8.1
Water flow	(l/h)	-	100	107	186	229	454	501	635	569	736	1081	1351	1327	1838
Water pressure drop	(kPa)	-	4	1	3	3	12	14	21	22	35	22	33	20	39
Standard coil, heating mode		Air inlet : 20°C, water inlet : 50°C, Water flow from cooling mode													
Total capacity	(kW)	-	0.6	0.7	1.4	1.7	3.3	3.5	4.5	4.2	5.7	6.9	8.9	9.5	13.5
Water flow	(l/h)	-	100	107	186	229	454	501	635	569	736	1081	1351	1327	1838
Water pressure drop	(kPa)	-	3	1	2	3	10	11	17	19	30	19	29	20	36
Electric heater															
Minimum electric heater capacity	(W)	-	500	500	500	500	500	500	1500	1500	1500	1500	1500	1500	1500
Absorbed current at minimum capacity	(A)	-	2.2	2.2	2.2	2.2	2.2	2.2	6.5	6.5	6.5	6.5	6.5	6.5	6.5
Maximum electric heater capacity	(W)	-	500	750	1000	1500	1500	1500	3000	4000	4000	4000	4000	4000	4000
Absorbed current at maximum capacity	(A)	-	2.2	3.3	4.3	6.5	6.5	6.5	13.0	17.4	17.4	17.4	17.4	17.4	17.4
Fan motor															
Absorbed Power	(W)	-	39	39	45	45	73	73	100	101	131	132	147	151	272
Maximum external static pressure	(Pa)	-	50	50	50	70	70	70	70	70	70	70	70	70	70
Sound levels															
Sound power level (3)	(dB(A))	-	53	52	54	54	58	56	56	62	62	60	62	65	64
Sound pressure level (4)	(dB(A))	-	33	32	34	34	38	36	36	42	42	40	42	45	44
NC levels (4)		-	27	25	28	28	33	32	33	35	35	32	35	39	37
NR levels (4)		-	28	26	28	28	34	34	34	36	37	33	36	40	39

(1) Levels according to Eurovent specification 8/2 (ISO 3741/88) and Eurovent FC Certification

(2) Values calculated from sound power levels with a hypothetical acoustic attenuation of 9 dB.

(3) Levels according to Eurovent specification 8/2 (ISO 3741/88) and Eurovent FCP Certification

(4) Values calculated from sound power levels with a hypothetical acoustic attenuation of 20 dB.

General Data

Table 13 - General Data - FED with inlet and discharge air connections

230V/50Hz/1ph, medium speed, 2 pipe, Eurovent program FC, 50 Pa

Unit size		100	200	300	400
Speed at ESP = 50 Pa		-	5	5	5
Airflow	(m ³ /h)	-	104	305	405
Voltage	(V)	-	5.1	6.6	5.7
Water connections		1/2" ISO R7 female gas			
Standard coil, cooling mode		Air inlet conditions : 27°C//19°C, Water : 7/12°C Constant delta T°			
Total capacity	(kW)	-	0.7	2.2	3.0
Sensible capacity	(kW)	-	0.5	1.5	2.0
Water flow	(l/h)	-	121	372	521
Water pressure drop	(kPa)	-	1	7	14
Water content	(l)	-	0.6	1.3	1.5
Standard coil, heating mode		Air inlet : 20°C, water inlet : 50°C, Water flow from cooling mode			
Total capacity	(kW)	-	0.8	2.5	3.3
Water flow	(l/h)	-	121	372	521
Water pressure drop	(kPa)	-	1	6	12
Electric heater					
Minimum electric heater capacity	(W)	-	500	500	1000
Absorbed current at minimum capacity	(A)	-	2.2	2.2	4.3
Maximum electric heater capacity	(W)	-	1000	2000	3000
Absorbed current at maximum capacity	(A)	-	4.3	8.7	13.0
Fan motor					
Absorbed Power	(W)	-	10	28	33
Maximum external static pressure	(Pa)	-	50	70	70
Sound levels					
Sound power level (3)	(dB(A))	-	51	61	57
Sound pressure level (4)	(dB(A))	-	31	41	37
NC levels (4)		-	24	35	33
NR levels (4)		-	25	37	35
Voltage range					
Minimum voltage	(V)	-	2.3	2.6	2.5
Maximum voltage	(V)	-	5.8	7.6	6.7

- (1) Levels according to Eurovent specification 8/2 (ISO 3741/88) and Eurovent FC Certification
 (2) Values calculated from sound power levels with a hypothetical acoustic attenuation of 9 dB.
 (3) Levels according to Eurovent specification 8/2 (ISO 3741/88) and Eurovent FCP Certification
 (4) Values calculated from sound power levels with a hypothetical acoustic attenuation of 20 dB.

General Data

Voltage data - FED

Electric heaters shall run with the minimum airflow described in following table. To maintain this minimum airflow the fan motor shall not run below the following voltage. This results in reduced airflow operating range described in the following table.

Table 14 - Minimum air flow (m3/h)function electric heater

M3/hr	Electric heater capacity					
Unit Size	500 W	750 W	1000 W	1500 W	2000 W	3000 W
FED 100	80					
FED 200	80	120	160			
FED 300	80	120	160	240	320	
FED 400			160	240	320	480

Voltage Range

2 and 4 pipe cooling or heating

FED100	Voltage	Airflow range
V min	2	
V medium	3.6	100 %
V max	5.1	

FED200	Voltage	Airflow range
V min	2.3	
V medium	4.1	100 %
V max	5.8	

FED300	Voltage	Airflow range
V min	2.6	
V medium	5.1	100 %
V max	5.8	

FED400	Voltage	Airflow range
V min	2.5	
V medium	4.6	100 %
V max	6.7	

Minimum voltage

2 pipe electric heat heating mode

FED100	
Electric heater capacity	500 W
V min	2.9
Airflow range	71 %

FED200			
Electric heater capacity	500 W	750 W	1000 W
V min	3.2	3.6	3.6
Airflow range	74 %	63 %	63 %

FED300					
Electric heater capacity	500 W	750 W	1000 W	1500 W	2000 W
V min	3.6	3.6	3.6	4.4	4.4
Airflow range	80 %	80 %	80 %	64 %	64 %

FED400				
Electric heater capacity	1000 W	1500 W	2000 W	3000 W
V min	3.6	3.6	4	4
Airflow range	74 %	74 %	64 %	64 %

Example

FED 300

Operating range without electric heater or in cooling mode Figure 16

Operating range for electric heater 500 W - 750 W - 1000 W in heating mode Figure 17

Operating range for electric heater 1500 W - 2000 W in heating mode Figure 18

General Data

Figure 16 - FED 300 Airflow operating range

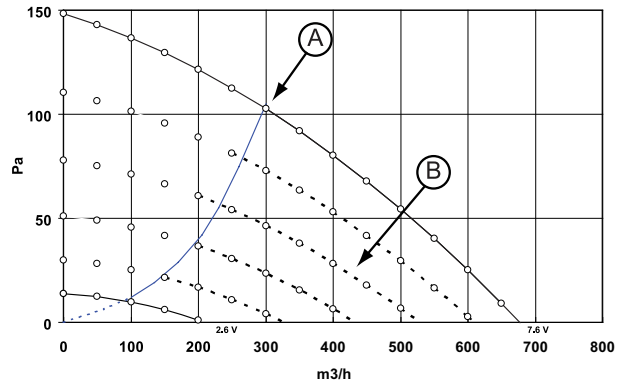

A = Airflow pressure drop system curve
 B = Standard selection operating system zone

Figure 17 - FED 300 with Electric Heater 500 W - 7500 W - 1000 W

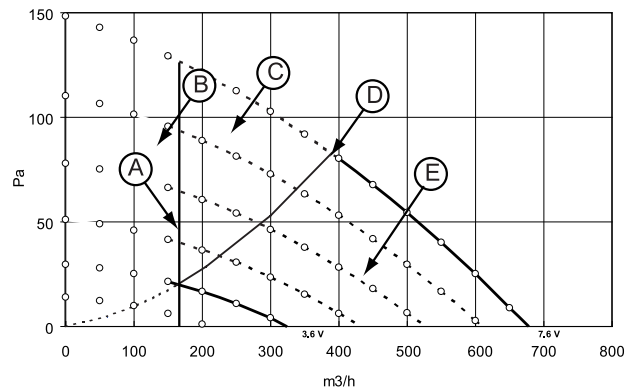

A = 160 m3/hr minimum airflow for 1000 W
 B = Not allowed operating system
 C = Special selection operating system zone
 D = Airflow pressure drop system curve
 E = Standard selection operating system zone

Figure 18 - FED 300 with Electric Heater 1500 W - 2000 W

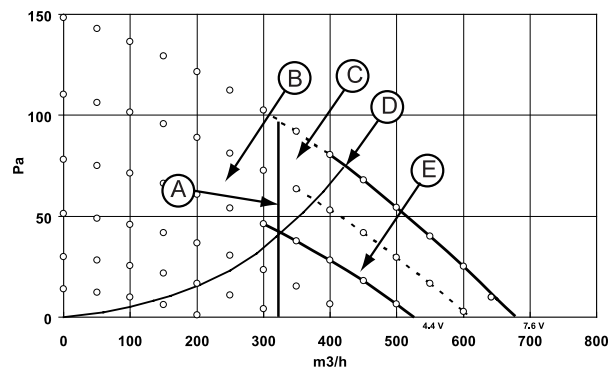

A = 320 m3/hr minimum airflow for 2000 W
 B = Not allowed operating system zone
 C = Special selection operating system zone
 D = Airflow pressure drop system curve
 E = Standard selection operating system zone

Cooling Capacities - FCD

Table 15 - Cooling capacities, 2-pipe standard capacity coil, 0Pa Unit with rectangular flange at the discharge side and EU3 filter, no inlet air connection

Return air temp. / Entering - leaving relative humidity	water temp.	Unit size		101	103	203	204	304	306	406	408	508	512	612	616	716	724
		Airflow	m ³ /h	227	313	380	465	501	695	697	1092	1286	1419	1541	2117	2169	2677
22°C / 50%	5-10°C	Tot. cap.	kW	1.1	1.4	1.4	1.6	2.2	2.8	3.2	4.4	4.0	4.2	7.0	8.6	8.7	10.2
		Sens. cap.	kW	0.9	1.2	1.3	1.5	1.9	2.5	2.7	3.8	3.5	3.7	5.8	7.4	7.4	8.8
		Water flow	l/h	191	241	240	281	376	488	553	754	683	727	1204	1488	1498	1765
	5.5-11°C	WPD	kPa	12	18	5	6	8	13	16	28	31	34	27	39	26	36
		Tot. cap.	kW	1.0	1.3	1.1	1.4	1.8	2.5	2.8	3.9	3.5	3.7	6.2	7.8	7.8	9.2
		Sens. cap.	kW	0.9	1.1	1.1	1.4	1.7	2.3	2.5	3.6	3.3	3.5	5.5	7.0	6.9	8.4
	6-12°C	Water flow	l/h	154	197	178	213	288	386	443	614	549	587	976	1220	1216	1445
		WPD	kPa	8	13	3	4	5	9	11	19	21	23	18	27	17	24
		Tot. cap.	kW	0.9	1.1	1.0	1.2	1.5	2.0	2.5	3.5	2.9	3.2	5.5	7.0	6.9	8.3
	7-12°C	Sens. cap.	kW	0.8	1.1	1.0	1.2	1.5	2.0	2.3	3.4	2.9	3.2	5.1	6.6	6.6	8.0
		Water flow	l/h	125	161	143	168	216	292	352	500	423	457	790	1001	986	1186
		WPD	kPa	6	9	2	3	3	5	7	13	13	15	13	19	11	16
8-13°C	Tot. cap.	kW	0.9	1.1	1.1	1.3	1.6	2.1	2.5	3.4	3.0	3.2	5.4	6.8	6.8	8.1	
	Sens. cap.	kW	0.8	1.1	1.1	1.3	1.6	2.1	2.3	3.4	3.0	3.2	5.1	6.6	6.5	7.9	
	Water flow	l/h	148	190	182	217	268	360	424	592	511	550	934	1174	1167	1394	
5-10°C	WPD	kPa	8	12	3	4	4	8	10	18	18	21	17	26	16	23	
	Tot. cap.	kW	0.7	1.0	0.9	1.1	1.4	1.9	2.1	3.0	2.7	2.9	4.6	5.9	5.8	7.1	
	Sens. cap.	kW	0.7	1.0	0.9	1.1	1.4	1.9	2.1	3.0	2.7	2.9	4.6	5.9	5.8	7.1	
5.5-11°C	Water flow	l/h	127	166	162	194	240	326	361	516	465	501	795	1020	1005	1216	
	WPD	kPa	6	10	2	3	4	6	8	14	15	18	13	20	12	17	
	Tot. cap.	kW	1.4	1.8	1.8	2.1	2.9	3.7	4.1	5.5	5.1	5.4	8.9	10.8	11.0	12.9	
6-12°C	Sens. cap.	kW	1.1	1.4	1.5	1.8	2.2	2.8	3.1	4.3	4.0	4.2	6.6	8.3	8.4	9.9	
	Water flow	l/h	243	303	318	366	498	632	711	952	878	929	1528	1868	1903	2216	
	WPD	kPa	18	27	8	10	14	21	25	43	48	54	41	59	42	56	
7-12°C	Tot. cap.	kW	1.3	1.6	1.6	1.9	2.5	3.3	3.7	5.0	4.6	4.8	8.0	9.9	10.0	11.7	
	Sens. cap.	kW	1.0	1.3	1.4	1.6	2.0	2.6	2.9	4.0	3.7	4.0	6.2	7.9	7.9	9.4	
	Water flow	l/h	199	250	250	290	397	511	581	784	713	757	1260	1548	1566	1834	
8-13°C	WPD	kPa	13	19	5	6	9	14	18	30	33	29	42	28	39		
	Tot. cap.	kW	1.1	1.4	1.3	1.6	2.2	2.9	3.3	4.5	4.0	4.3	7.2	8.9	9.0	10.6	
	Sens. cap.	kW	0.9	1.2	1.3	1.5	1.9	2.5	2.7	3.8	3.5	3.8	5.9	7.5	7.5	9.0	
5-10°C	Water flow	l/h	164	206	193	229	311	410	472	647	580	618	1037	1284	1288	1520	
	WPD	kPa	9	14	3	4	6	10	12	21	23	26	20	30	19	27	
	Tot. cap.	kW	1.1	1.4	1.4	1.7	2.2	2.9	3.3	4.4	4.0	4.3	7.1	8.7	8.8	10.3	
6-12°C	Sens. cap.	kW	0.9	1.2	1.3	1.6	1.9	2.5	2.7	3.8	3.5	3.8	5.8	7.4	7.4	8.9	
	Water flow	l/h	193	243	246	287	385	497	562	762	690	734	1219	1502	1515	1781	
	WPD	kPa	12	18	5	6	9	14	17	29	31	35	27	40	27	37	
7-12°C	Tot. cap.	kW	1.0	1.3	1.2	1.4	1.9	2.5	2.9	3.9	3.5	3.8	6.2	7.7	7.8	9.2	
	Sens. cap.	kW	0.9	1.1	1.2	1.4	1.8	2.3	2.5	3.6	3.3	3.6	5.5	7.0	7.0	8.4	
	Water flow	l/h	170	216	207	244	332	435	493	675	608	649	1075	1334	1337	1582	
8-13°C	WPD	kPa	10	15	4	5	7	11	13	23	25	28	22	32	21	29	
	Tot. cap.	kW	1.7	2.2	2.4	2.7	3.7	4.6	5.1	6.8	6.3	6.7	10.9	13.3	13.6	15.8	
	Sens. cap.	kW	1.2	1.5	1.7	2.0	2.5	3.2	3.5	4.8	4.5	4.8	7.4	9.3	9.4	11.1	
5-10°C	Water flow	l/h	300	372	407	464	630	792	881	1174	1094	1156	1880	2294	2346	2726	
	WPD	kPa	26	38	12	15	21	32	37	62	72	80	60	85	63	85	
	Tot. cap.	kW	1.6	2.0	2.1	2.4	3.3	4.2	4.7	6.3	5.8	6.1	10.1	12.3	12.6	14.6	
5.5-11°C	Sens. cap.	kW	1.1	1.4	1.6	1.9	2.3	3.0	3.3	4.5	4.2	4.5	7.1	8.9	8.9	10.6	
	Water flow	l/h	251	311	329	376	518	655	737	981	910	961	1581	1925	1968	2285	
	WPD	kPa	19	28	8	10	15	23	27	45	52	57	44	62	45	60	
6-12°C	Tot. cap.	kW	1.5	1.8	1.8	2.1	2.9	3.7	4.3	5.7	5.2	5.5	9.2	11.3	11.4	13.3	
	Sens. cap.	kW	1.1	1.4	1.5	1.7	2.2	2.8	3.1	4.3	4.0	4.3	6.7	8.4	8.5	10.1	
	Water flow	l/h	209	260	262	303	421	538	612	820	750	794	1324	1617	1644	1916	
7-12°C	WPD	kPa	14	21	5	7	10	16	19	33	36	40	32	46	31	42	
	Tot. cap.	kW	1.4	1.8	1.9	2.2	3.0	3.7	4.2	5.6	5.2	5.5	9.0	11.0	11.2	13.0	
	Sens. cap.	kW	1.1	1.4	1.5	1.8	2.2	2.8	3.1	4.3	4.0	4.3	6.6	8.3	8.4	9.9	
8-13°C	Water flow	l/h	247	307	326	374	511	645	726	967	891	942	1556	1895	1935	2248	
	WPD	kPa	19	27	8	10	14	22	26	44	50	55	42	61	43	58	
	Tot. cap.	kW	1.3	1.6	1.7	1.9	2.6	3.3	3.8	5.0	4.6	4.9	8.1	9.9	10.0	11.7	
5-10°C	Sens. cap.	kW	1.0	1.3	1.4	1.7	2.0	2.7	2.9	4.0	3.7	4.0	6.2	7.9	7.9	9.4	
	Water flow	l/h	221	276	287	331	451	573	647	866	790	837	1392	1700	1728	2015	
	WPD	kPa	16	23	6	8	11	18	21	36	40	44	35	50	35	47	
5.5-11°C	Tot. cap.	kW	2.1	2.6	2.9	3.3	4.4	5.6	6.1	8.2	7.7	8.1	13.1	16.0	16.3	19.0	
	Sens. cap.	kW	1.3	1.7	1.9	2.2	2.8	3.6	3.9	5.3	5.0	5.3	8.2	10.3	10.4	12.3	
	Water flow	l/h	361	448	504	572	765	959	1058	1410	1319	1394	2250	2751	2813	3270	
6-12°C	WPD	kPa	36	52	17	21	30	46	52	87	101	112	83	118	90	122	
	Tot. cap.	kW	2.0	2.4	2.7	3.0	4.1	5.2	5.7	7.6	7.1	7.5	12.3	14.9	15.3	17.7	
	Sens. cap.	kW	1.3	1.6	1.8	2.1	2.6	3.4	3.7	5.1	4.7	5.1	7.9	9.9	10.0	11.8	
7-12°C	Water flow	l/h	306	379	417	473	646	810	901	1197	1116	1179	1920	2340	2395	2779	
	WPD	kPa	27	39	12	15	22	34	39	65	75	82	62	89	66	88	
	Tot. cap.	kW	1.8	2.2	2.4	2.7	3.8	4.7	5.3	7.1	6.6	6.9	11.4	13.9	14.2	16.5	
8-13°C	Sens. cap.	kW	1.2	1.5	1.7	2.0	2.5	3.2	3.5	4.8	4.5	4.8	7.5	9.4	9.5	11.2	
	Water flow	l/h	260	321	341	390	542	681	766	1017	943	996	1640	1993	2041	2365	
	WPD	kPa	21	30	9	11	16	25	29	48	55	61	47	66	48	64	
5-10°C	Tot. cap.	kW	1.8	2.2	2.4	2.8	3.8	4.7	5.3	7.0	6.5	6.8	11.2	13.6	13.9	16.2	
	Sens. cap.	kW	1.2	1.5	1.7	2.0	2.5	3.2	3.5	4.8	4.5	4.8	7.4	9.3	9.4	11.1	
	Water flow	l/h	307	380	419	476	650	813	906	1200	1118	1180	1927	2345	2402	2785	
6-12°C	WPD	kPa	27	39	12	15	22	34	39	65	75	83	62	89	66	89	
	Tot. cap.	kW	1.6	2.0	2.2	2.5	3.4	4.3	4.8	6.3	5.9	6.2	10.2	12.4	12.7	14.7	
	Sens. cap.	kW	1.1	1.4	1.6	1.9	2.3	3.0	3.3	4.5	4.2	4.5	7.0	8.8	8.		

Cooling Capacities - FCD

Correction factors to be applied on the above values

Unit size	101	103	203	204	304	306	406	408	508	512	612	616	716	724
Airflow rate / ESP (m³/h / Pa)														
Speed 1	63	137	163	199	207	345	348	471	495	757	772	1240	1216	1714
Speed 2	78	159	189	231	241	391	394	542	564	924	967	1409	1384	1880
Speed 3	110	189	222	327	329	502	518	794	799	1033	1108	1571	1553	2053
Speed 4	140	222	270	374	380	566	581	908	948	1220	1291	1736	1748	2277
Speed 5	188	271	321	415	438	642	642	1004	1110	1329	1411	1890	1880	2491
Speed 6	227	313	380	465	501	695	697	1092	1286	1419	1541	2117	2169	2677
Total cooling capacity														
Speed 1	0.35	0.55	0.49	0.52	0.46	0.59	0.59	0.56	0.54	0.69	0.61	0.71	0.65	0.73
Speed 2	0.43	0.62	0.57	0.59	0.54	0.65	0.65	0.62	0.59	0.78	0.72	0.77	0.72	0.78
Speed 3	0.58	0.70	0.66	0.78	0.72	0.79	0.80	0.81	0.75	0.84	0.80	0.83	0.78	0.83
Speed 4	0.70	0.79	0.77	0.86	0.81	0.87	0.88	0.89	0.84	0.92	0.89	0.89	0.86	0.89
Speed 5	0.87	0.91	0.88	0.93	0.90	0.95	0.94	0.95	0.92	0.96	0.94	0.93	0.90	0.95
Speed 6	1.00	1.00	1.00	1.00	1.00	1.00	1.00	1.00	1.00	1.00	1.00	1.00	1.00	1.00
Sensible cooling capacity														
Speed 1	0.33	0.51	0.47	0.49	0.45	0.56	0.56	0.52	0.50	0.65	0.58	0.67	0.62	0.70
Speed 2	0.40	0.58	0.55	0.56	0.53	0.63	0.63	0.59	0.55	0.75	0.70	0.74	0.69	0.75
Speed 3	0.55	0.67	0.63	0.75	0.70	0.77	0.79	0.79	0.72	0.81	0.78	0.80	0.76	0.81
Speed 4	0.67	0.76	0.75	0.84	0.79	0.85	0.86	0.87	0.81	0.90	0.88	0.87	0.84	0.88
Speed 5	0.86	0.89	0.87	0.91	0.90	0.94	0.94	0.94	0.90	0.96	0.94	0.92	0.89	0.94
Speed 6	1.00	1.00	1.00	1.00	1.00	1.00	1.00	1.00	1.00	1.00	1.00	1.00	1.00	1.00

Cooling Capacities - FCD

**Table 16 - Cooling capacities, 4-pipe standard capacity coil, 0Pa
Unit with rectangular flange at the discharge side and EU3 filter, no inlet air connection**

Return air temp. / Entering - leaving relative humidity	water temp.	Unit size	101	103	203	204	304	306	406	408	508	512	612	616	716	724
			Airflow m ³ /h	205	300	366	456	501	686	688	1063	1259	1363	1489	1996	2089
22°C / 50%	5-10°C	Tot. cap. kW	1.0	1.4	1.4	1.6	2.2	2.8	3.2	4.3	3.9	4.1	6.8	8.3	8.4	9.9
		Sens. cap. kW	0.9	1.2	1.3	1.5	1.9	2.4	2.6	3.7	3.4	3.6	5.7	7.1	7.1	8.5
		Water flow l/h	178	234	233	277	376	484	548	741	674	710	1175	1433	1455	1713
	5.5-11°C	WPD kPa	11	17	4	6	8	13	16	27	30	33	26	37	25	34
		Tot. cap. kW	0.9	1.2	1.1	1.3	1.8	2.4	2.8	3.8	3.5	3.7	6.1	7.5	7.5	8.9
		Sens. cap. kW	0.8	1.1	1.1	1.3	1.7	2.3	2.5	3.5	3.2	3.4	5.3	6.7	6.7	8.1
	6-12°C	Water flow l/h	144	191	172	209	288	383	438	603	541	572	952	1172	1179	1401
		WPD kPa	7	12	3	4	5	8	11	19	20	22	18	26	16	23
		Tot. cap. kW	0.8	1.1	1.0	1.2	1.5	2.0	2.4	3.4	2.9	3.1	5.4	6.7	6.6	8.0
	7-12°C	Sens. cap. kW	0.8	1.0	1.0	1.2	1.5	2.0	2.3	3.3	2.9	3.1	5.0	6.3	6.3	7.7
		Water flow l/h	116	156	140	165	216	289	348	491	417	444	769	960	954	1148
		WPD kPa	5	9	2	2	3	5	7	13	13	14	12	18	11	15
8-13°C	Tot. cap. kW	0.8	1.1	1.0	1.2	1.6	2.1	2.4	3.4	2.9	3.1	5.3	6.5	6.6	7.8	
	Sens. cap. kW	0.8	1.0	1.0	1.2	1.6	2.1	2.3	3.3	2.9	3.1	5.0	6.3	6.3	7.6	
	Water flow l/h	138	184	177	214	268	357	419	581	503	535	910	1127	1130	1350	
24°C / 50%	5-10°C	WPD kPa	7	11	3	4	4	7	10	18	18	20	16	24	15	21
		Tot. cap. kW	0.7	0.9	0.9	1.1	1.4	1.9	2.1	2.9	2.7	2.8	4.5	5.7	5.6	6.8
		Sens. cap. kW	0.7	0.9	0.9	1.1	1.4	1.9	2.1	2.9	2.7	2.8	4.5	5.7	5.6	6.8
	5.5-11°C	Water flow l/h	118	161	156	190	240	323	357	506	457	487	774	975	972	1175
		WPD kPa	5	9	2	3	4	6	7	14	15	17	12	18	11	16
		Tot. cap. kW	1.3	1.7	1.8	2.1	2.9	3.6	4.1	5.4	5.0	5.3	8.7	10.5	10.7	12.5
	6-12°C	Sens. cap. kW	1.0	1.3	1.5	1.7	2.2	2.8	3.0	4.2	3.9	4.1	6.4	8.0	8.1	9.6
		Water flow l/h	227	294	310	361	498	627	704	936	868	909	1494	1801	1852	2155
		WPD kPa	16	25	7	9	14	21	25	42	47	52	39	55	40	53
	7-12°C	Tot. cap. kW	1.2	1.5	1.5	1.8	2.5	3.2	3.7	4.9	4.5	4.7	7.9	9.5	9.7	11.4
		Sens. cap. kW	0.9	1.2	1.4	1.6	2.0	2.6	2.9	4.0	3.7	3.9	6.1	7.6	7.7	9.1
		Water flow l/h	186	243	242	286	397	506	575	771	704	740	1232	1492	1522	1782
8-13°C	WPD kPa	12	18	5	6	9	14	17	29	33	36	28	39	27	37	
	Tot. cap. kW	1.1	1.4	1.3	1.6	2.2	2.8	3.3	4.4	4.0	4.2	7.1	8.6	8.7	10.3	
	Sens. cap. kW	0.9	1.2	1.3	1.5	1.9	2.4	2.7	3.7	3.5	3.7	5.7	7.2	7.2	8.7	
26°C / 50%	5-10°C	Water flow l/h	152	200	187	225	311	406	468	636	572	603	1013	1236	1250	1475
		WPD kPa	8	13	3	4	6	9	12	21	22	25	20	28	18	25
		Tot. cap. kW	1.0	1.4	1.4	1.6	2.2	2.9	3.2	4.3	4.0	4.2	6.9	8.4	8.5	10.0
	5.5-11°C	Sens. cap. kW	0.9	1.2	1.3	1.5	1.9	2.5	2.7	3.7	3.5	3.7	5.7	7.1	7.2	8.6
		Water flow l/h	180	236	239	283	385	492	557	749	681	717	1191	1447	1472	1729
		WPD kPa	11	17	5	6	9	13	16	28	31	34	26	37	25	35
	6-12°C	Tot. cap. kW	0.9	1.2	1.2	1.4	1.9	2.5	2.8	3.8	3.5	3.7	6.1	7.4	7.5	8.9
		Sens. cap. kW	0.8	1.1	1.2	1.4	1.8	2.3	2.5	3.5	3.3	3.5	5.3	6.7	6.7	8.1
		Water flow l/h	159	210	201	241	332	431	487	664	599	633	1049	1283	1298	1535
	7-12°C	WPD kPa	9	14	3	5	7	11	13	22	24	27	21	30	20	27
		Tot. cap. kW	1.6	2.1	2.3	2.7	3.7	4.6	5.1	6.7	6.3	6.6	10.7	12.8	13.3	15.4
		Sens. cap. kW	1.1	1.5	1.7	2.0	2.5	3.2	3.4	4.7	4.4	4.7	7.3	8.9	9.1	10.8
28°C / 50%	5-10°C	Water flow l/h	280	362	397	459	630	786	873	1155	1081	1132	1839	2214	2285	2652
		WPD kPa	23	36	11	14	21	32	37	61	71	77	57	80	60	80
		Tot. cap. kW	1.5	1.9	2.0	2.4	3.3	4.1	4.7	6.2	5.7	6.0	9.9	11.9	12.2	14.2
	5.5-11°C	Sens. cap. kW	1.0	1.4	1.6	1.8	2.3	3.0	3.3	4.5	4.2	4.4	6.9	8.5	8.7	10.3
		Water flow l/h	234	303	320	372	518	649	730	966	899	941	1546	1858	1916	2223
		WPD kPa	17	27	8	10	15	22	27	44	51	55	42	58	42	57
	6-12°C	Tot. cap. kW	1.4	1.8	1.8	2.1	2.9	3.7	4.2	5.6	5.2	5.4	9.0	10.9	11.1	13.0
		Sens. cap. kW	1.0	1.3	1.4	1.7	2.2	2.8	3.1	4.2	3.9	4.2	6.5	8.1	8.2	9.8
		Water flow l/h	195	253	255	299	421	533	606	807	741	776	1295	1560	1600	1863
	7-12°C	WPD kPa	13	20	5	7	10	16	19	32	36	39	31	43	30	40
		Tot. cap. kW	1.3	1.7	1.8	2.1	3.0	3.7	4.2	5.5	5.1	5.3	8.8	10.6	10.9	12.7
		Sens. cap. kW	1.0	1.3	1.5	1.7	2.2	2.8	3.0	4.2	3.9	4.1	6.5	8.0	8.1	9.6
8-13°C	Water flow l/h	231	299	318	369	511	640	719	951	881	922	1522	1829	1884	2187	
	WPD kPa	17	26	8	10	14	22	26	43	49	53	41	57	41	55	
	Tot. cap. kW	1.2	1.6	1.6	1.9	2.6	3.3	3.7	4.9	4.5	4.7	7.9	9.5	9.8	11.4	
30°C / 50%	5-10°C	Sens. cap. kW	0.9	1.2	1.4	1.6	2.0	2.6	2.9	4.0	3.7	3.9	6.1	7.5	7.6	9.1
		Water flow l/h	207	268	280	327	451	568	641	852	780	818	1361	1640	1681	1959
		WPD kPa	14	22	6	8	11	18	21	35	39	43	33	47	33	44
	5.5-11°C	Tot. cap. kW	2.0	2.5	2.9	3.3	4.4	5.5	6.1	8.1	7.6	7.9	12.8	15.4	15.9	18.4
		Sens. cap. kW	1.2	1.6	1.9	2.2	2.8	3.5	3.8	5.2	4.9	5.2	8.0	9.9	10.1	11.9
		Water flow l/h	337	435	492	565	765	951	1048	1388	1304	1364	2200	2653	2739	3180
	6-12°C	WPD kPa	32	50	16	21	30	45	51	84	99	107	79	111	86	115
		Tot. cap. kW	1.8	2.4	2.6	3.0	4.1	5.1	5.7	7.5	7.0	7.4	12.0	14.4	14.9	17.3
		Sens. cap. kW	1.2	1.6	1.8	2.1	2.6	3.4	3.7	5.0	4.7	4.9	7.7	9.5	9.7	11.4
	7-12°C	Water flow l/h	286	369	406	468	646	803	893	1178	1103	1154	1878	2258	2333	2704
		WPD kPa	24	37	12	15	22	33	38	63	73	79	60	83	62	84
		Tot. cap. kW	1.7	2.2	2.3	2.7	3.8	4.7	5.3	7.0	6.5	6.8	11.2	13.4	13.8	16.0
8-13°C	Sens. cap. kW	1.1	1.5	1.7	1.9	2.5	3.2	3.5	4.7	4.5	4.7	7.4	9.0	9.2	10.9	
	Water flow l/h	243	313	333	385	542	675	759	1001	932	975	1604	1924	1988	2302	
	WPD kPa	18	28	8	11	16	24	28	47	54	59	45	62	46	61	
9-13°C	Tot. cap. kW	1.7	2.1	2.4	2.7	3.8	4.7	5.2	6.9	6.4	6.7	10.9	13.1	13.6	15.7	
	Sens. cap. kW	1.1	1.5	1.7	2.0	2.5	3.2	3.4	4.7	4.4	4.7	7.3	8.9	9.1	10.8	
	Water flow l/h	288	370	409	470	650	807	897	1181	1105	1155	1885	2264	2340	2710	
10-13°C	WPD kPa	24	38	12	15	22	34	38	63	73	80	60	83	63	84	
	Tot. cap. kW	1.5	2.0	2.1	2.5	3.4	4.2	4.7	6.2	5.8	6.1	10.0	12.0	12.4	14.3	
	Sens. cap. kW	1.0	1.4	1.6	1.9	2.3	3.0	3.2	4.4	4.2	4.4	6.9	8.5	8.6	10.2	
11-13°C	Water flow l/h	262	336	366	422	588	730	817	1073	1001	1046	1720	2060	2130	2465	
	WPD kPa	21	32	10	12	19	28	33	53	61	67	51	70	52	70	

Cooling Capacities - FCD

Correction factors to be applied on the above values

Unit size	101	103	203	204	304	306	406	408	508	512	612	616	716	724
Airflow rate / ESP (m³/h / Pa)														
Speed 1	64	126	148	199	207	341	343	459	482	739	757	1210	1197	1688
Speed 2	72	149	174	232	241	386	389	531	551	898	943	1369	1361	1845
Speed 3	103	182	209	334	329	496	512	776	786	1005	1079	1514	1519	2009
Speed 4	131	217	251	375	380	559	574	887	932	1178	1254	1662	1702	2217
Speed 5	172	260	309	410	438	633	634	979	1091	1278	1367	1801	1828	2412
Speed 6	205	300	366	456	501	686	688	1063	1259	1363	1489	1996	2089	2573
Total cooling capacity														
Speed 1	0.39	0.53	0.48	0.54	0.48	0.60	0.59	0.57	0.54	0.70	0.62	0.73	0.67	0.74
Speed 2	0.43	0.61	0.55	0.61	0.55	0.66	0.65	0.63	0.60	0.79	0.73	0.79	0.73	0.79
Speed 3	0.59	0.71	0.65	0.81	0.72	0.80	0.81	0.82	0.76	0.84	0.80	0.84	0.80	0.84
Speed 4	0.71	0.80	0.76	0.88	0.81	0.87	0.88	0.89	0.84	0.92	0.89	0.89	0.86	0.90
Speed 5	0.88	0.91	0.89	0.93	0.91	0.95	0.94	0.95	0.92	0.97	0.95	0.94	0.91	0.96
Speed 6	1.00	1.00	1.00	1.00	1.00	1.00	1.00	1.00	1.00	1.00	1.00	1.00	1.00	1.00
Sensible cooling capacity														
Speed 1	0.37	0.50	0.48	0.51	0.46	0.57	0.57	0.53	0.50	0.66	0.59	0.69	0.64	0.72
Speed 2	0.41	0.57	0.55	0.58	0.54	0.63	0.63	0.59	0.56	0.76	0.71	0.76	0.71	0.77
Speed 3	0.56	0.67	0.65	0.78	0.71	0.78	0.79	0.79	0.73	0.82	0.78	0.82	0.78	0.82
Speed 4	0.69	0.78	0.76	0.86	0.80	0.85	0.87	0.88	0.82	0.91	0.88	0.88	0.85	0.89
Speed 5	0.87	0.90	0.89	0.92	0.90	0.94	0.94	0.94	0.91	0.96	0.94	0.93	0.90	0.95
Speed 6	1.00	1.00	1.00	1.00	1.00	1.00	1.00	1.00	1.00	1.00	1.00	1.00	1.00	1.00

Cooling Capacities - FCD

Table 17 - Cooling capacities, 2-pipe standard capacity coil, 50Pa in speed 5
Unit with return air duct connection D200mm, discharge air duct connection D200mm and EU3 filter(s)

Return air temp. / Entering - leaving relative humidity	Unit size	101	103	203	204	304	306	406	408	508	512	612	616	716	724
5-10°C	Airflow m ³ /h	-	70	86	182	198	425	419	565	614	902	912	1233	1281	1973
	Tot. cap. kW	-	0.5	0.5	0.8	1.1	1.9	2.2	2.8	2.4	3.2	4.7	6.0	5.7	8.1
	Sens. cap. kW	-	0.4	0.4	0.7	0.9	1.7	1.8	2.3	2.0	2.7	3.8	4.9	4.7	6.8
	Water flow l/h	-	79	90	137	183	333	372	477	412	545	815	1028	983	1399
5.5-11°C	WPD kPa	-	3	1	2	2	7	8	12	12	20	13	20	11	23
	Tot. cap. kW	-	0.4	0.5	0.7	1.0	1.6	1.8	2.4	2.0	2.7	4.1	5.3	4.9	7.2
	Sens. cap. kW	-	0.4	0.4	0.7	0.8	1.5	1.6	2.1	1.9	2.5	3.5	4.6	4.4	6.4
	Water flow l/h	-	66	75	115	152	252	288	379	314	430	644	827	772	1132
22°C / 50%	WPD kPa	-	2	1	1	2	4	5	8	8	13	9	14	7	15
	Tot. cap. kW	-	0.4	0.4	0.7	0.9	1.4	1.5	2.1	1.6	2.2	3.5	4.6	4.1	6.4
	Sens. cap. kW	-	0.3	0.4	0.7	0.8	1.4	1.5	2.0	1.6	2.2	3.3	4.3	4.0	6.1
	Water flow l/h	-	56	63	97	128	198	219	297	224	321	498	660	595	914
7-12°C	WPD kPa	-	1	0	1	1	2	3	5	4	8	5	9	4	10
	Tot. cap. kW	-	0.4	0.4	0.6	0.8	1.4	1.6	2.1	1.7	2.4	3.5	4.6	4.3	6.3
	Sens. cap. kW	-	0.3	0.4	0.6	0.8	1.4	1.5	2.0	1.7	2.4	3.3	4.3	4.1	6.0
	Water flow l/h	-	63	72	109	145	235	275	363	285	413	611	788	735	1085
8-13°C	WPD kPa	-	2	1	1	1	3	5	8	6	12	8	12	6	14
	Tot. cap. kW	-	0.3	0.4	0.6	0.7	1.2	1.3	1.8	1.5	2.1	2.9	3.8	3.6	5.4
	Sens. cap. kW	-	0.3	0.4	0.6	0.7	1.2	1.3	1.8	1.5	2.1	2.9	3.8	3.6	5.4
	Water flow l/h	-	57	64	101	129	212	230	306	256	356	506	662	616	930
5-10°C	WPD kPa	-	2	0	1	1	3	6	5	10	6	9	4	10	
	Tot. cap. kW	-	0.6	0.6	1.0	1.3	2.6	2.8	3.6	3.2	4.1	6.1	7.6	7.5	10.3
	Sens. cap. kW	-	0.4	0.5	0.8	1.0	1.9	2.1	2.6	2.4	3.1	4.4	5.6	5.5	7.8
	Water flow l/h	-	101	110	177	226	444	489	617	556	715	1055	1315	1286	1783
5.5-11°C	WPD kPa	-	4	1	3	3	11	13	20	21	33	21	31	19	37
	Tot. cap. kW	-	0.5	0.6	0.9	1.2	2.2	2.5	3.2	2.8	3.7	5.5	6.9	6.6	9.3
	Sens. cap. kW	-	0.4	0.5	0.8	0.9	1.8	1.9	2.5	2.2	2.9	4.1	5.3	5.1	7.4
	Water flow l/h	-	82	92	140	189	352	394	502	439	574	862	1081	1041	1465
24°C / 50%	WPD kPa	-	3	1	2	2	7	9	14	14	23	15	22	13	25
	Tot. cap. kW	-	0.5	0.5	0.8	1.1	1.9	2.2	2.8	2.4	3.2	4.8	6.2	5.8	8.4
	Sens. cap. kW	-	0.4	0.4	0.7	0.9	1.6	1.8	2.3	2.0	2.7	3.8	4.9	4.7	6.9
	Water flow l/h	-	69	78	118	160	272	312	406	341	459	695	884	834	1201
7-12°C	WPD kPa	-	2	1	1	2	5	6	9	9	15	10	15	8	17
	Tot. cap. kW	-	0.5	0.5	0.8	1.1	2.0	2.2	2.8	2.4	3.2	4.8	6.1	5.8	8.2
	Sens. cap. kW	-	0.4	0.4	0.7	0.9	1.7	1.8	2.3	2.0	2.7	3.8	4.9	4.7	6.9
	Water flow l/h	-	81	90	137	183	342	381	486	421	553	831	1044	1002	1417
8-13°C	WPD kPa	-	3	1	2	2	7	8	13	13	21	14	21	12	23
	Tot. cap. kW	-	0.4	0.5	0.7	0.9	1.7	1.9	2.5	2.1	2.8	4.2	5.3	5.0	7.2
	Sens. cap. kW	-	0.3	0.4	0.7	0.8	1.6	1.7	2.2	1.9	2.6	3.6	4.6	4.4	6.5
	Water flow l/h	-	71	80	124	163	294	329	424	360	481	722	915	868	1248
5-10°C	WPD kPa	-	2	1	1	2	5	6	10	10	16	11	16	9	18
	Tot. cap. kW	-	0.7	0.8	1.4	1.7	3.3	3.5	4.4	4.1	5.2	7.6	9.4	9.3	12.8
	Sens. cap. kW	-	0.5	0.5	1.0	1.2	2.2	2.4	3.0	2.7	3.6	5.0	6.3	6.2	8.8
	Water flow l/h	-	124	132	237	297	564	610	765	700	894	1305	1621	1598	2200
5.5-11°C	WPD kPa	-	6	2	5	5	17	19	29	32	50	31	46	30	56
	Tot. cap. kW	-	0.7	0.7	1.2	1.5	3.0	3.2	4.1	3.7	4.7	7.0	8.7	8.5	11.8
	Sens. cap. kW	-	0.5	0.5	0.9	1.0	2.1	2.2	2.8	2.6	3.4	4.8	6.0	5.9	8.3
	Water flow l/h	-	104	112	185	233	463	509	640	580	743	1097	1363	1337	1846
26°C / 50%	WPD kPa	-	4	1	3	3	12	14	21	23	36	23	33	21	39
	Tot. cap. kW	-	0.6	0.7	1.0	1.4	2.6	2.9	3.7	3.3	4.2	6.4	7.9	7.7	10.7
	Sens. cap. kW	-	0.4	0.5	0.8	1.0	1.9	2.1	2.7	2.4	3.2	4.5	5.7	5.5	7.9
	Water flow l/h	-	87	95	144	197	375	419	531	470	608	913	1139	1106	1540
7-12°C	WPD kPa	-	3	1	2	2	8	10	15	16	25	16	24	14	27
	Tot. cap. kW	-	0.6	0.6	1.1	1.3	2.7	2.9	3.7	3.3	4.2	6.3	7.8	7.6	10.5
	Sens. cap. kW	-	0.4	0.5	0.8	1.0	1.9	2.1	2.6	2.4	3.2	4.4	5.6	5.5	7.8
	Water flow l/h	-	104	110	185	232	457	503	631	569	728	1082	1343	1317	1815
8-13°C	WPD kPa	-	4	1	3	3	12	14	20	22	35	22	33	20	38
	Tot. cap. kW	-	0.5	0.6	0.9	1.2	2.3	2.6	3.3	2.9	3.7	5.6	7.0	6.8	9.4
	Sens. cap. kW	-	0.4	0.4	0.8	0.9	1.8	1.9	2.5	2.2	2.9	4.1	5.3	5.1	7.3
	Water flow l/h	-	93	100	159	205	403	446	562	497	641	964	1199	1166	1620
5-10°C	WPD kPa	-	4	1	2	3	9	11	17	17	27	18	27	16	30
	Tot. cap. kW	-	0.9	0.9	1.7	2.1	4.0	4.3	5.3	4.9	6.3	9.1	11.2	11.1	15.3
	Sens. cap. kW	-	0.5	0.6	1.1	1.3	2.5	2.6	3.3	3.1	4.0	5.6	7.0	6.9	9.7
	Water flow l/h	-	147	156	299	367	684	733	918	846	1078	1561	1938	1918	2635
5.5-11°C	WPD kPa	-	8	2	7	8	25	27	40	45	70	43	63	42	79
	Tot. cap. kW	-	0.8	0.9	1.6	2.0	3.7	4.0	5.0	4.6	5.8	8.5	10.6	10.4	14.3
	Sens. cap. kW	-	0.5	0.6	1.0	1.2	2.4	2.5	3.2	2.9	3.8	5.3	6.7	6.6	9.3
	Water flow l/h	-	126	133	244	307	577	625	782	716	913	1336	1657	1636	2246
28°C / 50%	WPD kPa	-	6	2	5	6	18	20	30	34	52	32	48	31	58
	Tot. cap. kW	-	0.8	0.8	1.4	1.7	3.4	3.7	4.6	4.2	5.4	7.9	9.9	9.7	13.3
	Sens. cap. kW	-	0.5	0.5	0.9	1.1	2.2	2.4	3.0	2.7	3.6	5.1	6.4	6.3	8.9
	Water flow l/h	-	108	115	195	248	484	531	666	604	772	1142	1416	1392	1914
7-12°C	WPD kPa	-	5	1	3	4	13	15	23	25	38	24	36	23	42
	Tot. cap. kW	-	0.7	0.8	1.4	1.8	3.4	3.7	4.6	4.2	5.3	7.8	9.7	9.5	13.1
	Sens. cap. kW	-	0.5	0.5	1.0	1.2	2.2	2.4	3.0	2.7	3.6	5.0	6.3	6.2	8.8
	Water flow l/h	-	128	134	247	311	582	631	788	721	917	1346	1665	1646	2254
8-13°C	WPD kPa	-	6	2	5	6	18	20	30	34	52	33	48	31	58
	Tot. cap. kW	-	0.7	0.7	1.3	1.6	3.1	3.3	4.2	3.8	4.8	7.1	8.8	8.7	11.9
	Sens. cap. kW	-	0.5	0.5	0.9	1.1	2.1	2.2	2.8	2.6	3.4	4.7	6.0	5.8	8.3
	Water flow l/h	-	118	122	220	279	527	576	719	655	832	1231	1521	1501	2054
	WPD kPa	-	5	1	4	5	15	17	26	29	44	28	41	26	49

Tot. cap. Total cooling capacity
Sens. cap. Sensible cooling capacity
WPD Water pressure drop

Data given at high speed

Cooling Capacities - FCD

Correction factors to be applied on the above values

Unit size	101	103	203	204	304	306	406	408	508	512	612	616	716	724
Airflow rate / ESP (m³/h / Pa)														
Speed 1	-	40 / 18	50 / 19	104 / 18	107 / 16	258 / 21	256 / 20	325 / 18	316 / 15	592 / 23	581 / 22	962 / 33	981 / 31	1510 / 31
Speed 2	-	46 / 24	57 / 25	121 / 24	123 / 22	282 / 25	287 / 26	371 / 23	360 / 19	686 / 32	680 / 31	1040 / 39	1080 / 38	1609 / 35
Speed 3	-	52 / 32	67 / 34	153 / 39	159 / 36	343 / 37	354 / 39	481 / 39	488 / 35	757 / 38	750 / 37	1089 / 42	1135 / 42	1707 / 40
Speed 4	-	59 / 40	73 / 40	163 / 44	174 / 44	371 / 43	379 / 45	519 / 45	540 / 43	826 / 46	826 / 45	1136 / 46	1199 / 47	1820 / 45
Speed 5	-	65 / 50	81 / 50	174 / 50	187 / 50	402 / 50	400 / 50	554 / 50	585 / 50	864 / 50	869 / 50	1184 / 50	1237 / 50	1911 / 50
Speed 6	-	70 / 57	86 / 57	182 / 55	198 / 56	425 / 56	419 / 55	565 / 54	614 / 55	902 / 54	912 / 55	1233 / 54	1281 / 54	1973 / 53
Total cooling capacity														
Speed 1	-	0.58	0.65	0.62	0.62	0.65	0.65	0.64	0.59	0.76	0.70	0.84	0.81	0.82
Speed 2	-	0.65	0.73	0.69	0.69	0.70	0.72	0.72	0.66	0.84	0.79	0.89	0.88	0.86
Speed 3	-	0.74	0.81	0.83	0.82	0.84	0.86	0.88	0.84	0.89	0.86	0.91	0.91	0.90
Speed 4	-	0.83	0.87	0.89	0.88	0.89	0.92	0.93	0.91	0.95	0.93	0.94	0.95	0.94
Speed 5	-	0.93	0.94	0.95	0.93	0.95	0.96	0.97	0.96	0.97	0.96	0.97	0.97	0.98
Speed 6	-	1.00	1.00	1.00	1.00	1.00	1.00	1.00	1.00	1.00	1.00	1.00	1.00	1.00
Sensible cooling capacity														
Speed 1	-	0.57	0.61	0.60	0.59	0.64	0.64	0.62	0.58	0.74	0.68	0.82	0.80	0.80
Speed 2	-	0.64	0.69	0.67	0.66	0.69	0.71	0.70	0.65	0.82	0.78	0.87	0.87	0.85
Speed 3	-	0.73	0.78	0.83	0.81	0.83	0.86	0.87	0.83	0.88	0.85	0.91	0.90	0.89
Speed 4	-	0.82	0.84	0.89	0.87	0.89	0.91	0.93	0.90	0.94	0.92	0.94	0.94	0.94
Speed 5	-	0.92	0.93	0.95	0.93	0.95	0.96	0.97	0.96	0.97	0.96	0.97	0.97	0.97
Speed 6	-	1.00	1.00	1.00	1.00	1.00	1.00	1.00	1.00	1.00	1.00	1.00	1.00	1.00

Cooling Capacities - FCD

**Table 18 - Cooling capacities. 4-pipe standard capacity coil, 50Pa in speed 5
Unit with return air duct connection D200mm, discharge air duct connection D200mm and EU3 filter(s)**

Return air temp. / Entering - leaving relative humidity water temp.	Unit size	101	103	203	204	304	306	406	408	508	512	612	616	716	724	
5-10°C	Airflow m ³ /h	-	71	83	172	198	418	412	553	605	868	886	1178	1228	1912	
	Tot. cap. kW	-	0.5	0.5	0.8	1.1	1.9	2.1	2.7	2.4	3.1	4.6	5.8	5.5	7.9	
	Sens. cap. kW	-	0.4	0.4	0.7	0.9	1.6	1.7	2.2	2.0	2.6	3.7	4.7	4.5	6.7	
5.5-11°C	Water flow l/h	-	80	87	133	183	329	367	470	407	531	796	994	948	1366	
	WPD kPa	-	3	1	2	2	6	8	12	12	20	13	19	11	22	
	Tot. cap. kW	-	0.4	0.5	0.7	1.0	1.6	1.8	2.4	2.0	2.7	4.0	5.1	4.7	7.0	
22°C / 50%	5.5-11°C	Sens. cap. kW	-	0.4	0.4	0.7	0.8	1.5	1.6	2.1	1.8	2.5	3.4	4.4	4.2	6.3
	Water flow l/h	-	67	73	112	152	248	283	372	310	418	628	798	742	1103	
	WPD kPa	-	2	1	1	2	4	5	8	7	13	8	13	6	14	
6-12°C	Tot. cap. kW	-	0.4	0.4	0.7	0.9	1.4	1.5	2.0	1.5	2.2	3.4	4.4	4.0	6.2	
	Sens. cap. kW	-	0.3	0.4	0.6	0.8	1.4	1.5	1.9	1.5	2.2	3.2	4.1	3.8	5.9	
	Water flow l/h	-	56	61	94	128	196	217	291	222	310	484	634	568	889	
7-12°C	WPD kPa	-	2	0	1	1	2	3	5	4	7	5	8	4	9	
	Tot. cap. kW	-	0.4	0.4	0.6	0.8	1.3	1.6	2.1	1.6	2.3	3.5	4.4	4.1	6.1	
	Sens. cap. kW	-	0.3	0.4	0.6	0.8	1.3	1.5	2.0	1.6	2.3	3.2	4.1	3.9	5.9	
8-13°C	Water flow l/h	-	64	70	105	145	232	271	356	281	401	596	760	706	1057	
	WPD kPa	-	2	1	1	1	3	4	7	6	12	8	12	6	13	
	Tot. cap. kW	-	0.3	0.4	0.6	0.7	1.2	1.3	1.7	1.5	2.0	2.9	3.7	3.4	5.2	
24°C / 50%	8-13°C	Sens. cap. kW	-	0.3	0.3	0.6	0.7	1.2	1.3	1.7	1.5	2.0	2.9	3.7	3.4	5.2
	Water flow l/h	-	57	62	97	129	210	226	301	253	346	493	637	591	905	
	WPD kPa	-	2	0	1	1	3	3	5	5	9	5	9	4	10	
5-10°C	Tot. cap. kW	-	0.6	0.6	1.0	1.3	2.5	2.8	3.5	3.2	4.0	6.0	7.4	7.2	10.1	
	Sens. cap. kW	-	0.4	0.5	0.8	1.0	1.9	2.0	2.6	2.4	3.1	4.3	5.4	5.3	7.6	
	Water flow l/h	-	102	106	168	226	439	483	607	550	698	1032	1273	1245	1743	
5.5-11°C	WPD kPa	-	4	1	2	3	11	13	19	21	32	20	30	18	35	
	Tot. cap. kW	-	0.5	0.6	0.9	1.2	2.2	2.5	3.2	2.8	3.6	5.4	6.7	6.4	9.1	
	Sens. cap. kW	-	0.4	0.4	0.7	0.9	1.8	1.9	2.4	2.2	2.9	4.0	5.1	4.9	7.2	
6-12°C	Water flow l/h	-	83	90	136	189	348	389	495	434	560	842	1046	1006	1431	
	WPD kPa	-	3	1	2	2	7	9	13	14	21	14	21	12	24	
	Tot. cap. kW	-	0.5	0.5	0.8	1.1	1.9	2.1	2.8	2.3	3.1	4.7	5.9	5.6	8.2	
7-12°C	8-13°C	Sens. cap. kW	-	0.4	0.4	0.7	0.9	1.6	1.7	2.3	2.0	2.7	3.8	4.8	4.5	6.7
	Water flow l/h	-	69	76	115	160	269	308	399	337	447	679	854	803	1172	
	WPD kPa	-	2	1	1	2	4	6	9	9	14	10	14	8	16	
8-13°C	Tot. cap. kW	-	0.5	0.5	0.8	1.1	2.0	2.2	2.8	2.4	3.1	4.7	5.9	5.6	8.0	
	Sens. cap. kW	-	0.4	0.4	0.7	0.9	1.7	1.8	2.3	2.0	2.7	3.7	4.7	4.6	6.7	
	Water flow l/h	-	82	87	133	183	338	376	479	416	539	813	1010	967	1383	
26°C / 50%	8-13°C	WPD kPa	-	3	1	2	2	7	8	12	13	20	13	20	11	22
	Tot. cap. kW	-	0.4	0.5	0.7	0.9	1.7	1.9	2.4	2.1	2.7	4.1	5.1	4.9	7.1	
	Sens. cap. kW	-	0.3	0.4	0.7	0.8	1.5	1.6	2.1	1.9	2.5	3.5	4.4	4.2	6.3	
5-10°C	Water flow l/h	-	71	78	120	163	291	324	418	356	468	706	885	836	1217	
	WPD kPa	-	2	1	1	2	5	6	10	9	16	10	15	8	17	
	Tot. cap. kW	-	0.7	0.7	1.3	1.7	3.2	3.5	4.4	4.0	5.1	7.4	9.1	9.0	12.5	
5.5-11°C	8-13°C	Sens. cap. kW	-	0.5	0.5	0.9	1.2	2.2	2.3	2.9	2.7	3.5	4.9	6.1	6.0	8.6
	Water flow l/h	-	125	128	227	297	557	603	754	693	873	1277	1570	1547	2151	
	WPD kPa	-	6	2	4	5	17	19	28	32	48	30	43	28	53	
6-12°C	5.5-11°C	Tot. cap. kW	-	0.7	0.7	1.1	1.5	2.9	3.2	4.0	3.7	4.6	6.9	8.4	8.3	11.5
	Sens. cap. kW	-	0.5	0.5	0.8	1.0	2.1	2.2	2.8	2.5	3.3	4.6	5.8	5.7	8.1	
	Water flow l/h	-	105	109	176	233	458	503	631	574	725	1074	1321	1295	1805	
26°C / 50%	6-12°C	WPD kPa	-	4	1	3	3	12	14	20	23	34	22	32	20	38
	Tot. cap. kW	-	0.6	0.6	1.0	1.4	2.6	2.9	3.6	3.2	4.1	6.2	7.7	7.4	10.5	
	Sens. cap. kW	-	0.4	0.5	0.8	1.0	1.9	2.0	2.6	2.4	3.1	4.4	5.5	5.3	7.7	
7-12°C	Water flow l/h	-	88	93	140	197	370	414	523	465	594	893	1103	1070	1505	
	WPD kPa	-	3	1	2	2	8	10	15	15	24	16	23	13	26	
	Tot. cap. kW	-	0.6	0.6	1.0	1.3	2.6	2.9	3.6	3.3	4.1	6.1	7.5	7.4	10.3	
8-13°C	7-12°C	Sens. cap. kW	-	0.4	0.5	0.8	1.0	1.9	2.0	2.6	2.4	3.1	4.3	5.4	5.3	7.6
	Water flow l/h	-	105	107	176	232	452	497	622	564	711	1059	1301	1275	1775	
	WPD kPa	-	4	1	3	3	11	13	20	22	33	21	31	19	36	
28°C / 50%	8-13°C	Tot. cap. kW	-	0.5	0.6	0.9	1.2	2.3	2.6	3.2	2.9	3.6	5.5	6.7	6.5	9.2
	Sens. cap. kW	-	0.4	0.4	0.7	0.9	1.8	1.9	2.4	2.2	2.9	4.0	5.1	4.9	7.1	
	Water flow l/h	-	94	97	151	205	398	440	554	492	626	943	1162	1128	1583	
5-10°C	8-13°C	WPD kPa	-	4	1	2	3	9	11	16	17	26	17	25	15	29
	Tot. cap. kW	-	0.9	0.9	1.7	2.1	3.9	4.2	5.2	4.9	6.1	8.9	10.9	10.8	14.9	
	Sens. cap. kW	-	0.5	0.6	1.1	1.3	2.5	2.6	3.3	3.0	3.9	5.5	6.8	6.7	9.5	
5.5-11°C	Water flow l/h	-	149	151	286	367	676	724	904	837	1053	1528	1878	1858	2577	
	WPD kPa	-	8	2	6	8	24	26	39	44	67	41	60	40	76	
	Tot. cap. kW	-	0.8	0.8	1.5	2.0	3.6	3.9	4.9	4.5	5.7	8.3	10.2	10.1	14.0	
6-12°C	5.5-11°C	Sens. cap. kW	-	0.5	0.5	1.0	1.2	2.3	2.5	3.1	2.9	3.7	5.2	6.5	6.4	9.1
	Water flow l/h	-	128	129	233	307	571	618	771	709	892	1308	1606	1584	2196	
	WPD kPa	-	6	2	4	6	18	20	29	33	50	31	45	29	55	
7-12°C	6-12°C	Tot. cap. kW	-	0.8	0.8	1.3	1.7	3.3	3.7	4.6	4.2	5.2	7.8	9.6	9.4	13.0
	Sens. cap. kW	-	0.5	0.5	0.9	1.1	2.2	2.3	3.0	2.7	3.5	5.0	6.2	6.1	8.7	
	Water flow l/h	-	109	111	185	248	479	525	656	598	754	1117	1372	1348	1872	
8-13°C	7-12°C	WPD kPa	-	5	1	3	4	13	15	22	24	37	23	34	21	40
	Tot. cap. kW	-	0.8	0.8	1.4	1.8	3.3	3.6	4.5	4.1	5.2	7.6	9.4	9.3	12.8	
	Sens. cap. kW	-	0.5	0.5	0.9	1.2	2.2	2.3	2.9	2.7	3.5	4.9	6.1	6.0	8.6	
28°C / 50%	8-13°C	Water flow l/h	-	130	130	236	311	576	623	777	714	896	1317	1614	1595	2205
	WPD kPa	-	6	2	5	6	18	20	30	33	50	31	45	29	56	
	Tot. cap. kW	-	0.7	0.7	1.2	1.6	3.0	3.3	4.1	3.8	4.7	7.0	8.6	8.4	11.7	
28°C / 50%	8-13°C	Sens. cap. kW	-	0.5	0.5	0.9	1.1	2.1	2.2	2.8	2.5	3.3	4.6	5.8	5.7	8.1
	Water flow l/h	-	119	119	210	279	521	569	709	648	813	1205	1475	1454	2009	
	WPD kPa	-	5	1	4	5	15	17	25	28	42	27	39	25	46	

Tot. cap. Total cooling capacity
Sens. cap. Sensible cooling capacity
WPD Water pressure drop

Data given at high speed

Cooling Capacities - FCD

Correction factors to be applied on the above values

Unit size	101	103	203	204	304	306	406	408	508	512	612	616	716	724
Airflow rate / ESP (m³/h / Pa)														
Speed 1	-	39 / 17	46 / 19	100 / 18	107 / 16	254 / 21	253 / 21	319 / 18	312 / 15	577 / 24	569 / 23	933 / 34	959 / 32	1484 / 32
Speed 2	-	46 / 23	52 / 24	113 / 23	123 / 22	279 / 25	283 / 26	364 / 23	355 / 19	666 / 32	665 / 31	1005 / 39	1052 / 39	1576 / 36
Speed 3	-	53 / 31	60 / 32	144 / 38	159 / 36	339 / 37	349 / 39	472 / 39	481 / 35	734 / 39	733 / 37	1049 / 43	1101 / 43	1666 / 40
Speed 4	-	60 / 41	67 / 40	157 / 45	174 / 44	366 / 37	374 / 45	508 / 45	532 / 43	797 / 46	804 / 45	1091 / 46	1160 / 47	1771 / 46
Speed 5	-	67 / 50	75 / 50	166 / 50	187 / 50	396 / 50	394 / 50	533 / 50	577 / 50	833 / 50	846 / 50	1135 / 50	1191 / 50	1854 / 50
Speed 6	-	71 / 56	83 / 60	172 / 54	198 / 56	418 / 56	412 / 55	553 / 54	605 / 55	868 / 54	886 / 55	1178 / 54	1228 / 53	1912 / 53
Total cooling capacity														
Speed 1	-	0.56	0.64	0.62	0.60	0.66	0.66	0.65	0.60	0.77	0.70	0.85	0.82	0.83
Speed 2	-	0.64	0.70	0.67	0.66	0.71	0.72	0.72	0.67	0.85	0.80	0.89	0.89	0.87
Speed 3	-	0.74	0.78	0.83	0.80	0.84	0.87	0.88	0.85	0.90	0.86	0.92	0.92	0.91
Speed 4	-	0.84	0.85	0.90	0.87	0.90	0.92	0.93	0.91	0.95	0.93	0.95	0.96	0.95
Speed 5	-	0.94	0.93	0.96	0.94	0.95	0.96	0.97	0.96	0.97	0.96	0.97	0.98	0.98
Speed 6	-	1.00	1.00	1.00	1.00	1.00	1.00	1.00	1.00	1.00	1.00	1.00	1.00	1.00
Sensible cooling capacity														
Speed 1	-	0.55	0.60	0.60	0.58	0.64	0.64	0.63	0.59	0.75	0.69	0.83	0.81	0.82
Speed 2	-	0.63	0.67	0.66	0.65	0.70	0.71	0.70	0.65	0.83	0.79	0.88	0.88	0.86
Speed 3	-	0.73	0.75	0.83	0.80	0.83	0.86	0.87	0.83	0.89	0.86	0.91	0.91	0.90
Speed 4	-	0.83	0.83	0.90	0.87	0.89	0.91	0.93	0.90	0.94	0.92	0.94	0.95	0.94
Speed 5	-	0.93	0.91	0.95	0.94	0.95	0.96	0.97	0.96	0.97	0.96	0.97	0.97	0.97
Speed 6	-	1.00	1.00	1.00	1.00	1.00	1.00	1.00	1.00	1.00	1.00	1.00	1.00	1.00

Cooling Capacities - FED

**Table 19 - Cooling capacities, 2-pipe standard capacity coil, 0Pa
Unit with rectangular flange at the discharge side and EU3 filter, no inlet air connection**

Return air temp. / relative humidity	Entering - leaving water temp.	Unit size	100	200	300	400	
			Airflow m ³ /h	370	503	677	1069
		Voltage	5.1	5.8	7.6	6.7	
22°C / 50%	5-10°C	Tot. cap.	kW	1.16	1.49	2.55	4.02
		Sens. cap.	kW	1.03	1.44	2.23	3.47
		Water flow	l/h	200	257	439	693
		WPD	kPa	13	5	10	24
	5.5-11°C	Tot. cap.	kW	1.03	1.24	2.19	3.58
		Sens. cap.	kW	0.97	1.24	2.07	3.27
		Water flow	l/h	161	194	343	561
		WPD	kPa	9	3	6	17
	6-12°C	Tot. cap.	kW	0.87	1.05	1.79	3.16
		Sens. cap.	kW	0.87	1.05	1.79	3.09
		Water flow	l/h	126	150	257	454
		WPD	kPa	6	2	4	11
7-12°C	Tot. cap.	kW	0.88	1.15	1.87	3.13	
	Sens. cap.	kW	0.88	1.15	1.87	3.08	
	Water flow	l/h	151	198	322	540	
	WPD	kPa	8	3	5	15	
8-13°C	Tot. cap.	kW	0.80	1.02	1.68	2.73	
	Sens. cap.	kW	0.80	1.02	1.68	2.73	
	Water flow	l/h	137	175	289	470	
	WPD	kPa	7	3	5	12	
24°C / 50%	5-10°C	Tot. cap.	kW	1.49	1.97	3.35	5.12
		Sens. cap.	kW	1.17	1.65	2.57	3.94
		Water flow	l/h	256	339	577	883
		WPD	kPa	20	8	16	37
	5.5-11°C	Tot. cap.	kW	1.33	1.70	2.95	4.62
		Sens. cap.	kW	1.10	1.54	2.40	3.72
		Water flow	l/h	208	266	462	724
		WPD	kPa	14	6	11	26
	6-12°C	Tot. cap.	kW	1.18	1.44	2.55	4.13
		Sens. cap.	kW	1.04	1.43	2.23	3.51
		Water flow	l/h	169	207	366	593
		WPD	kPa	10	4	7	18
7-12°C	Tot. cap.	kW	1.17	1.53	2.60	4.07	
	Sens. cap.	kW	1.04	1.47	2.25	3.49	
	Water flow	l/h	202	263	448	701	
	WPD	kPa	13	5	10	25	
8-13°C	Tot. cap.	kW	1.03	1.31	2.26	3.59	
	Sens. cap.	kW	0.98	1.31	2.12	3.29	
	Water flow	l/h	178	225	390	619	
	WPD	kPa	11	4	8	20	
26°C / 50%	5-10°C	Tot. cap.	kW	1.87	2.53	4.23	6.35
		Sens. cap.	kW	1.32	1.88	2.93	4.44
		Water flow	l/h	321	436	729	1095
		WPD	kPa	30	13	24	55
	5.5-11°C	Tot. cap.	kW	1.69	2.23	3.83	5.83
		Sens. cap.	kW	1.25	1.75	2.76	4.21
		Water flow	l/h	266	350	600	914
		WPD	kPa	21	9	17	40
	6-12°C	Tot. cap.	kW	1.52	1.94	3.40	5.29
		Sens. cap.	kW	1.18	1.64	2.58	3.98
		Water flow	l/h	218	279	488	759
		WPD	kPa	15	6	12	29
7-12°C	Tot. cap.	kW	1.51	2.01	3.42	5.21	
	Sens. cap.	kW	1.18	1.67	2.59	3.95	
	Water flow	l/h	260	347	590	898	
	WPD	kPa	21	9	16	38	
8-13°C	Tot. cap.	kW	1.34	1.77	3.02	4.64	
	Sens. cap.	kW	1.11	1.57	2.42	3.72	
	Water flow	l/h	231	306	521	801	
	WPD	kPa	17	7	13	31	
28°C / 50%	5-10°C	Tot. cap.	kW	2.26	3.14	5.14	7.65
		Sens. cap.	kW	1.47	2.11	3.28	4.92
		Water flow	l/h	390	542	886	1318
		WPD	kPa	41	19	34	77
	5.5-11°C	Tot. cap.	kW	2.09	2.85	4.76	7.14
		Sens. cap.	kW	1.40	1.99	3.11	4.70
		Water flow	l/h	328	447	746	1118
		WPD	kPa	31	14	25	57
	6-12°C	Tot. cap.	kW	1.92	2.53	4.36	6.60
		Sens. cap.	kW	1.33	1.86	2.94	4.48
		Water flow	l/h	276	364	626	948
		WPD	kPa	23	10	18	42
7-12°C	Tot. cap.	kW	1.91	2.60	4.35	6.50	
	Sens. cap.	kW	1.33	1.89	2.94	4.44	
	Water flow	l/h	328	447	750	1120	
	WPD	kPa	31	14	25	57	
8-13°C	Tot. cap.	kW	1.72	2.32	3.93	5.90	
	Sens. cap.	kW	1.25	1.78	2.77	4.19	
	Water flow	l/h	296	399	677	1017	
	WPD	kPa	26	11	21	48	

Tot. cap. Total cooling capacity
Sens. cap. Sensible cooling capacity
WPD Water pressure drop

Data given at high speed

Cooling Capacities - FED

Correction factors to be applied on the above values

Unit size	100	200	300	400
Voltage (V)				
Speed 1	2.0	2.3	2.6	2.5
Speed 2	2.6	3.0	3.6	3.3
Speed 3	3.2	3.7	4.6	4.1
Speed 4	3.8	4.4	5.6	4.9
Speed 5	4.4	5.1	6.6	5.7
Speed 6	5.1	5.8	7.6	6.7
Airflow rate (m3/h) / ESP (Pa)				
Speed 1	106	169	210	347
Speed 2	154	237	325	483
Speed 3	204	306	432	635
Speed 4	257	375	527	785
Speed 5	310	441	609	924
Speed 6	370	503	677	1069
Total cooling capacity				
Speed 1	0.42	0.41	0.38	0.45
Speed 2	0.56	0.56	0.57	0.58
Speed 3	0.68	0.70	0.72	0.71
Speed 4	0.80	0.81	0.84	0.82
Speed 5	0.90	0.91	0.93	0.91
Speed 6	1.00	1.00	1.00	1.00
Sensible cooling capacity				
Speed 1	0.38	0.39	0.36	0.41
Speed 2	0.52	0.54	0.55	0.54
Speed 3	0.64	0.67	0.70	0.68
Speed 4	0.77	0.79	0.82	0.80
Speed 5	0.88	0.90	0.92	0.90
Speed 6	1.00	1.00	1.00	1.00

Cooling Capacities - FED

**Table 20 - Cooling capacities, 4-pipe standard capacity coil, 0Pa
Unit with rectangular flange at the discharge side and EU3 filter, no inlet air connection**

Return air temp. / relative humidity	Entering - leaving water temp.	Unit size	100	200	300	400	
			Airflow m ³ /h	338	475	668	997
		Voltage	5.1	5.8	7.6	6.7	
22°C / 50%	5-10°C	Tot. cap.	kW	1.09	1.43	2.52	3.84
		Sens. cap.	kW	0.96	1.38	2.21	3.30
		Water flow	l/h	188	246	435	662
		WPD	kPa	12	5	9	22
	5.5-11°C	Tot. cap.	kW	0.82	1.01	1.77	3.00
		Sens. cap.	kW	0.82	1.01	1.77	2.93
		Water flow	l/h	117	145	254	431
		WPD	kPa	5	2	4	10
	6-12°C	Tot. cap.	kW	0.82	1.01	1.77	3.00
		Sens. cap.	kW	0.82	1.01	1.77	2.93
		Water flow	l/h	117	145	254	431
		WPD	kPa	5	2	4	10
7-12°C	Tot. cap.	kW	0.82	1.09	1.85	2.98	
	Sens. cap.	kW	0.82	1.09	1.85	2.92	
	Water flow	l/h	141	189	318	514	
	WPD	kPa	7	3	5	14	
8-13°C	Tot. cap.	kW	0.74	0.96	1.66	2.59	
	Sens. cap.	kW	0.74	0.96	1.66	2.59	
	Water flow	l/h	128	166	286	446	
	WPD	kPa	6	2	4	11	
24°C / 50%	5-10°C	Tot. cap.	kW	1.41	1.89	3.32	4.91
		Sens. cap.	kW	1.10	1.58	2.55	3.75
		Water flow	l/h	243	326	572	846
		WPD	kPa	18	8	16	35
	5.5-11°C	Tot. cap.	kW	1.25	1.63	2.92	4.42
		Sens. cap.	kW	1.03	1.47	2.38	3.54
		Water flow	l/h	197	255	457	693
		WPD	kPa	13	5	10	24
	6-12°C	Tot. cap.	kW	1.11	1.37	2.52	3.94
		Sens. cap.	kW	0.97	1.37	2.21	3.34
		Water flow	l/h	160	197	362	566
		WPD	kPa	9	3	7	17
7-12°C	Tot. cap.	kW	1.10	1.46	2.57	3.89	
	Sens. cap.	kW	0.97	1.40	2.23	3.32	
	Water flow	l/h	190	252	444	671	
	WPD	kPa	12	5	10	23	
8-13°C	Tot. cap.	kW	0.97	1.25	2.24	3.43	
	Sens. cap.	kW	0.92	1.25	2.09	3.13	
	Water flow	l/h	167	215	386	591	
	WPD	kPa	10	4	8	18	
26°C / 50%	5-10°C	Tot. cap.	kW	1.77	2.44	4.19	6.09
		Sens. cap.	kW	1.25	1.80	2.90	4.23
		Water flow	l/h	305	421	723	1050
		WPD	kPa	27	12	24	51
	5.5-11°C	Tot. cap.	kW	1.61	2.15	3.79	5.59
		Sens. cap.	kW	1.18	1.68	2.73	4.01
		Water flow	l/h	252	337	594	876
		WPD	kPa	19	8	17	37
	6-12°C	Tot. cap.	kW	1.44	1.86	3.37	5.07
		Sens. cap.	kW	1.11	1.57	2.55	3.79
		Water flow	l/h	207	267	484	728
		WPD	kPa	14	6	11	26
7-12°C	Tot. cap.	kW	1.43	1.94	3.39	4.99	
	Sens. cap.	kW	1.10	1.59	2.56	3.76	
	Water flow	l/h	246	334	585	861	
	WPD	kPa	19	8	16	36	
8-13°C	Tot. cap.	kW	1.27	1.70	2.99	4.45	
	Sens. cap.	kW	1.04	1.50	2.40	3.54	
	Water flow	l/h	218	293	516	767	
	WPD	kPa	15	7	13	29	
28°C / 50%	5-10°C	Tot. cap.	kW	2.14	3.03	5.09	7.33
		Sens. cap.	kW	1.39	2.02	3.25	4.70
		Water flow	l/h	369	523	878	1264
		WPD	kPa	38	18	34	71
	5.5-11°C	Tot. cap.	kW	1.99	2.75	4.72	6.85
		Sens. cap.	kW	1.32	1.91	3.08	4.49
		Water flow	l/h	311	431	740	1073
		WPD	kPa	28	13	25	53
	6-12°C	Tot. cap.	kW	1.82	2.44	4.32	6.33
		Sens. cap.	kW	1.25	1.79	2.91	4.27
		Water flow	l/h	262	351	620	910
		WPD	kPa	21	9	18	39
7-12°C	Tot. cap.	kW	1.81	2.51	4.31	6.24	
	Sens. cap.	kW	1.25	1.81	2.91	4.23	
	Water flow	l/h	312	432	743	1075	
	WPD	kPa	28	13	25	53	
8-13°C	Tot. cap.	kW	1.63	2.24	3.89	5.66	
	Sens. cap.	kW	1.18	1.71	2.74	4.00	
	Water flow	l/h	281	385	671	976	
	WPD	kPa	24	11	21	45	

Tot. cap. Total cooling capacity
Sens. cap. Sensible cooling capacity
WPD Water pressure drop
Data given at high speed

Cooling Capacities - FED

Correction factors to be applied on the above values

Unit size	100	200	300	400
Voltage (V)				
Speed 1	2.0	2.3	2.6	2.5
Speed 2	2.6	3.0	3.6	3.3
Speed 3	3.2	3.7	4.6	4.1
Speed 4	3.8	4.4	5.6	4.9
Speed 5	4.4	5.1	6.6	5.7
Speed 6	5.1	5.8	7.6	6.7
Airflow rate (m3/h) / ESP (Pa)				
Speed 1	91	159	205	347
Speed 2	131	225	316	483
Speed 3	177	291	418	635
Speed 4	226	355	509	785
Speed 5	278	416	592	924
Speed 6	338	475	668	997
Total cooling capacity				
Speed 1	0.40	0.41	0.37	0.45
Speed 2	0.53	0.56	0.56	0.58
Speed 3	0.65	0.69	0.71	0.71
Speed 4	0.77	0.81	0.82	0.82
Speed 5	0.88	0.91	0.92	0.91
Speed 6	1.00	1.00	1.00	1.00
Sensible cooling capacity				
Speed 1	0.36	0.39	0.36	0.41
Speed 2	0.49	0.54	0.54	0.54
Speed 3	0.62	0.67	0.69	0.68
Speed 4	0.74	0.79	0.81	0.80
Speed 5	0.87	0.90	0.91	0.90
Speed 6	1.00	1.00	1.00	1.00

Cooling Capacities - FED

**Table 21 - Cooling capacities, 2-pipe standard capacity coil, 50Pa in speed 5
Unit with return air duct connection D200mm, discharge air duct connection D200mm and EU3 filter(s)**

Return air temp. / relative humidity	Entering - leaving water temp.	Unit size	100				200				300				400					
			Airflow m ³ /h	Voltage V	Tot. cap. kW	Sens. cap. kW	Water flow l/h	WPD kPa	Tot. cap. kW	Sens. cap. kW	Water flow l/h	WPD kPa	Tot. cap. kW	Sens. cap. kW	Water flow l/h	WPD kPa	Tot. cap. kW	Sens. cap. kW	Water flow l/h	WPD kPa
22°C / 50%	5-10°C	Tot. cap.	-	-	0.55	1.43	2.24	1.85	386	8	-	-	-	-	-	-	-	-	-	-
		Sens. cap.	-	-	0.46	1.25	1.85	1.85	386	8	-	-	-	-	-	-	-	-	-	-
		Water flow	-	-	95	246	386	386	386	8	-	-	-	-	-	-	-	-	-	-
		WPD	-	-	1	3	8	8	8	8	-	-	-	-	-	-	-	-	-	-
	5.5-11°C	Tot. cap.	-	-	0.50	1.28	1.90	1.70	298	5	-	-	-	-	-	-	-	-	-	-
		Sens. cap.	-	-	0.44	1.19	1.70	1.70	298	5	-	-	-	-	-	-	-	-	-	-
		Water flow	-	-	78	200	298	298	298	5	-	-	-	-	-	-	-	-	-	-
		WPD	-	-	1	2	5	5	5	5	-	-	-	-	-	-	-	-	-	-
	6-12°C	Tot. cap.	-	-	0.45	1.17	1.55	1.55	223	3	-	-	-	-	-	-	-	-	-	-
		Sens. cap.	-	-	0.42	1.14	1.55	1.55	223	3	-	-	-	-	-	-	-	-	-	-
		Water flow	-	-	65	168	223	223	223	3	-	-	-	-	-	-	-	-	-	-
		WPD	-	-	0	2	3	3	3	3	-	-	-	-	-	-	-	-	-	-
7-12°C	Tot. cap.	-	-	0.43	1.08	1.65	1.59	284	5	-	-	-	-	-	-	-	-	-	-	
	Sens. cap.	-	-	0.41	1.08	1.59	1.59	284	5	-	-	-	-	-	-	-	-	-	-	
	Water flow	-	-	74	186	284	284	284	5	-	-	-	-	-	-	-	-	-	-	
	WPD	-	-	1	2	5	5	5	5	-	-	-	-	-	-	-	-	-	-	
8-13°C	Tot. cap.	-	-	0.37	0.99	1.38	1.38	238	4	-	-	-	-	-	-	-	-	-	-	
	Sens. cap.	-	-	0.37	0.99	1.38	1.38	238	4	-	-	-	-	-	-	-	-	-	-	
	Water flow	-	-	64	171	238	238	238	4	-	-	-	-	-	-	-	-	-	-	
	WPD	-	-	0	2	4	4	4	4	-	-	-	-	-	-	-	-	-	-	
24°C / 50%	5-10°C	Tot. cap.	-	-	0.68	2.01	2.97	2.17	512	14	-	-	-	-	-	-	-	-	-	-
		Sens. cap.	-	-	0.52	1.51	2.17	2.17	512	14	-	-	-	-	-	-	-	-	-	-
		Water flow	-	-	118	347	512	512	512	14	-	-	-	-	-	-	-	-	-	-
		WPD	-	-	1	6	14	14	14	14	-	-	-	-	-	-	-	-	-	-
	5.5-11°C	Tot. cap.	-	-	0.63	1.69	2.62	2.01	411	9	-	-	-	-	-	-	-	-	-	-
		Sens. cap.	-	-	0.50	1.36	2.01	2.01	411	9	-	-	-	-	-	-	-	-	-	-
		Water flow	-	-	98	264	411	411	411	9	-	-	-	-	-	-	-	-	-	-
		WPD	-	-	1	4	9	9	9	9	-	-	-	-	-	-	-	-	-	-
	6-12°C	Tot. cap.	-	-	0.57	1.45	2.25	1.85	323	6	-	-	-	-	-	-	-	-	-	-
		Sens. cap.	-	-	0.47	1.26	1.85	1.85	323	6	-	-	-	-	-	-	-	-	-	-
		Water flow	-	-	82	208	323	323	323	6	-	-	-	-	-	-	-	-	-	-
		WPD	-	-	1	2	6	6	6	6	-	-	-	-	-	-	-	-	-	-
7-12°C	Tot. cap.	-	-	0.55	1.48	2.29	1.87	395	9	-	-	-	-	-	-	-	-	-	-	
	Sens. cap.	-	-	0.46	1.28	1.87	1.87	395	9	-	-	-	-	-	-	-	-	-	-	
	Water flow	-	-	94	256	395	395	395	9	-	-	-	-	-	-	-	-	-	-	
	WPD	-	-	1	4	9	9	9	9	-	-	-	-	-	-	-	-	-	-	
8-13°C	Tot. cap.	-	-	0.49	1.25	1.97	1.73	340	7	-	-	-	-	-	-	-	-	-	-	
	Sens. cap.	-	-	0.44	1.18	1.73	1.73	340	7	-	-	-	-	-	-	-	-	-	-	
	Water flow	-	-	84	215	340	340	340	7	-	-	-	-	-	-	-	-	-	-	
	WPD	-	-	1	3	7	7	7	7	-	-	-	-	-	-	-	-	-	-	
26°C / 50%	5-10°C	Tot. cap.	-	-	0.84	2.62	3.73	2.48	642	21	-	-	-	-	-	-	-	-	-	-
		Sens. cap.	-	-	0.58	1.76	2.48	2.48	642	21	-	-	-	-	-	-	-	-	-	-
		Water flow	-	-	145	451	642	642	642	21	-	-	-	-	-	-	-	-	-	-
		WPD	-	-	2	10	21	21	21	21	-	-	-	-	-	-	-	-	-	-
	5.5-11°C	Tot. cap.	-	-	0.77	2.33	3.41	2.34	535	15	-	-	-	-	-	-	-	-	-	-
		Sens. cap.	-	-	0.55	1.63	2.34	2.34	535	15	-	-	-	-	-	-	-	-	-	-
		Water flow	-	-	121	365	535	535	535	15	-	-	-	-	-	-	-	-	-	-
		WPD	-	-	1	7	15	15	15	15	-	-	-	-	-	-	-	-	-	-
	6-12°C	Tot. cap.	-	-	0.71	1.99	3.05	2.18	438	11	-	-	-	-	-	-	-	-	-	-
		Sens. cap.	-	-	0.53	1.48	2.18	2.18	438	11	-	-	-	-	-	-	-	-	-	-
		Water flow	-	-	102	286	438	438	438	11	-	-	-	-	-	-	-	-	-	-
		WPD	-	-	1	4	11	11	11	11	-	-	-	-	-	-	-	-	-	-
7-12°C	Tot. cap.	-	-	0.69	2.09	3.05	2.18	438	11	-	-	-	-	-	-	-	-	-	-	
	Sens. cap.	-	-	0.52	1.52	2.18	2.18	438	11	-	-	-	-	-	-	-	-	-	-	
	Water flow	-	-	119	359	438	438	438	11	-	-	-	-	-	-	-	-	-	-	
	WPD	-	-	1	7	15	15	15	15	-	-	-	-	-	-	-	-	-	-	
8-13°C	Tot. cap.	-	-	0.62	1.81	2.69	2.03	344	10	-	-	-	-	-	-	-	-	-	-	
	Sens. cap.	-	-	0.49	1.41	2.03	2.03	344	10	-	-	-	-	-	-	-	-	-	-	
	Water flow	-	-	106	311	438	438	438	10	-	-	-	-	-	-	-	-	-	-	
	WPD	-	-	1	5	12	12	12	12	-	-	-	-	-	-	-	-	-	-	
28°C / 50%	5-10°C	Tot. cap.	-	-	1.08	3.20	4.49	2.78	774	30	-	-	-	-	-	-	-	-	-	-
		Sens. cap.	-	-	0.68	1.99	2.78	2.78	774	30	-	-	-	-	-	-	-	-	-	-
		Water flow	-	-	186	552	774	774	774	30	-	-	-	-	-	-	-	-	-	-
		WPD	-	-	3	15	30	30	30	30	-	-	-	-	-	-	-	-	-	-
	5.5-11°C	Tot. cap.	-	-	0.94	2.96	4.20	2.64	658	22	-	-	-	-	-	-	-	-	-	-
		Sens. cap.	-	-	0.62	1.87	2.64	2.64	658	22	-	-	-	-	-	-	-	-	-	-
		Water flow	-	-	147	464	658	658	658	22	-	-	-	-	-	-	-	-	-	-
		WPD	-	-	2	11	22	22	22	22	-	-	-	-	-	-	-	-	-	-
	6-12°C	Tot. cap.	-	-	0.87	2.68	3.88	2.50	558	16	-	-	-	-	-	-	-	-	-	-
		Sens. cap.	-	-	0.59	1.75	2.50	2.50	558	16	-	-	-	-	-	-	-	-	-	-
		Water flow	-	-	125	385	558	558	558	16	-	-	-	-	-	-	-	-	-	-
		WPD	-	-	1	8	16	16	16	16	-	-	-	-	-	-	-	-	-	-
7-12°C	Tot. cap.	-	-	0.85	2.71	3.85	2.48	663	22	-	-	-	-	-	-	-	-	-	-	
	Sens. cap.	-	-	0.58	1.77	2.48	2.48	663	22	-	-	-	-	-	-	-	-	-	-	
	Water flow	-	-	146	468	663	663	663	22	-	-	-	-	-	-	-	-	-	-	
	WPD	-	-	2	11	22	22	22	22	-	-	-	-	-	-	-	-	-	-	
8-13°C	Tot. cap.	-	-	0.77	2.45	3.50	2.34	504	19	-	-	-	-	-	-	-	-	-	-	
	Sens. cap.	-	-	0.55	1.65	2.34	2.34	504	19	-	-	-	-	-	-	-	-	-	-	
	Water flow	-	-	132	422	504	504	504	19	-	-	-	-	-	-	-	-	-	-	
	WPD	-	-	2	9	19	19	19	19	-	-	-	-	-	-	-	-	-	-	

Tot. cap. Total cooling capacity
Sens. cap. Sensible cooling capacity
WPD Water pressure drop

Data given at high speed

Cooling Capacities - FED

Correction factors to be applied on the above values

Unit size	100	200	300	400
Voltage (V)				
Speed 1	-	2.3	2.6	2.5
Speed 2	-	3.0	3.6	3.3
Speed 3	-	3.7	4.6	4.1
Speed 4	-	4.4	5.6	4.9
Speed 5	-	5.1	6.6	5.7
Speed 6	-	5.8	7.6	6.7
Airflow rate (m3/h) / ESP (Pa)				
Speed 1	-	42 / 8	109 / 6	166 / 8
Speed 2	-	57 / 15	163 / 14	220 / 15
Speed 3	-	73 / 25	213 / 24	280 / 24
Speed 4	-	88 / 36	260 / 36	342 / 36
Speed 5	-	104 / 50	305 / 50	405 / 50
Speed 6	-	120 / 66	346 / 65	480 / 71
Total cooling capacity				
Speed 1	-	0.49	0.39	0.39
Speed 2	-	0.62	0.52	0.51
Speed 3	-	0.73	0.63	0.64
Speed 4	-	0.83	0.77	0.76
Speed 5	-	0.92	0.89	0.87
Speed 6	-	1.00	1.00	1.00
Sensible cooling capacity				
Speed 1	-	0.44	0.37	0.38
Speed 2	-	0.56	0.50	0.50
Speed 3	-	0.68	0.63	0.63
Speed 4	-	0.79	0.77	0.75
Speed 5	-	0.90	0.89	0.86
Speed 6	-	1.00	1.00	1.00

Cooling Capacities - FED

**Table 22 - Cooling capacities, 4-pipe standard capacity coil, 50Pa in speed 5
Unit with return air duct connection D200mm, discharge air duct connection D200mm and EU3 filter(s)**

Return air temp. / relative humidity	Entering - leaving water temp.	Unit size	100				200				300				400					
			Airflow m ³ /h	Voltage V	Tot. cap. kW	Sens. cap. kW	Water flow l/h	WPD kPa	Tot. cap. kW	Sens. cap. kW	Water flow l/h	WPD kPa	Tot. cap. kW	Sens. cap. kW	Water flow l/h	WPD kPa	Tot. cap. kW	Sens. cap. kW	Water flow l/h	WPD kPa
22°C / 50%	5-10°C	Tot. cap.	-	-	-	-	0.54	0.46	93	1	1.40	1.23	242	3	2.08	1.72	359	7		
		Sens. cap.	-	-	-	-	0.46	0.43	77	1	1.26	1.17	198	2	1.75	1.57	274	5		
		Water flow	-	-	-	-	93	77	198	1	1.16	1.13	166	2	1.48	1.45	212	3		
		WPD	-	-	-	-	1	0.49	0.42	0	0.45	0.42	0	2	1.48	1.45	212	3		
	5.5-11°C	Tot. cap.	-	-	-	-	0.49	0.43	77	1	1.11	1.10	191	2	1.51	1.47	261	4		
		Sens. cap.	-	-	-	-	0.43	0.37	63	1	1.00	0.98	169	2	1.27	1.27	218	3		
		Water flow	-	-	-	-	77	63	169	1	0.98	0.98	169	2	1.27	1.27	218	3		
		WPD	-	-	-	-	1	0.37	0.37	0	0.37	0.37	0	2	1.27	1.27	218	3		
	6-12°C	Tot. cap.	-	-	-	-	0.45	0.43	73	1	1.11	1.10	191	2	1.51	1.47	261	4		
		Sens. cap.	-	-	-	-	0.45	0.37	63	1	1.00	0.98	169	2	1.27	1.27	218	3		
		Water flow	-	-	-	-	65	63	169	1	0.98	0.98	169	2	1.27	1.27	218	3		
		WPD	-	-	-	-	0	0.37	0.37	0	0.37	0.37	0	2	1.27	1.27	218	3		
7-12°C	Tot. cap.	-	-	-	-	0.43	0.43	73	1	1.11	1.10	191	2	1.51	1.47	261	4			
	Sens. cap.	-	-	-	-	0.43	0.37	63	1	1.00	0.98	169	2	1.27	1.27	218	3			
	Water flow	-	-	-	-	73	63	169	1	0.98	0.98	169	2	1.27	1.27	218	3			
	WPD	-	-	-	-	1	0.37	0.37	0	0.37	0.37	0	2	1.27	1.27	218	3			
8-13°C	Tot. cap.	-	-	-	-	0.68	0.51	117	1	1.99	1.49	342	6	2.78	2.02	478	12			
	Sens. cap.	-	-	-	-	0.68	0.49	97	1	1.66	1.34	260	4	1.87	1.87	382	8			
	Water flow	-	-	-	-	117	97	260	1	1.49	1.34	260	4	1.87	1.87	382	8			
	WPD	-	-	-	-	1	0.62	0.62	1	1.66	1.34	260	4	1.87	1.87	382	8			
24°C / 50%	5-10°C	Tot. cap.	-	-	-	0.57	0.51	81	1	1.43	1.25	206	2	2.08	1.71	299	5			
		Sens. cap.	-	-	-	-	0.51	0.47	81	1	1.25	1.25	206	2	1.71	1.71	299	5		
		Water flow	-	-	-	-	81	81	206	1	1.25	1.25	206	2	1.71	1.71	299	5		
		WPD	-	-	-	-	1	0.57	0.57	1	1.43	1.25	206	2	1.71	1.71	299	5		
	5.5-11°C	Tot. cap.	-	-	-	-	0.62	0.49	97	1	1.66	1.34	260	4	2.44	1.87	382	8		
		Sens. cap.	-	-	-	-	0.49	0.49	97	1	1.34	1.34	260	4	1.87	1.87	382	8		
		Water flow	-	-	-	-	97	97	260	1	1.34	1.34	260	4	1.87	1.87	382	8		
		WPD	-	-	-	-	1	0.62	0.62	1	1.66	1.34	260	4	1.87	1.87	382	8		
	6-12°C	Tot. cap.	-	-	-	-	0.57	0.47	81	1	1.43	1.25	206	2	2.08	1.71	299	5		
		Sens. cap.	-	-	-	-	0.47	0.47	81	1	1.25	1.25	206	2	1.71	1.71	299	5		
		Water flow	-	-	-	-	81	81	206	1	1.25	1.25	206	2	1.71	1.71	299	5		
		WPD	-	-	-	-	1	0.57	0.57	1	1.43	1.25	206	2	1.71	1.71	299	5		
7-12°C	Tot. cap.	-	-	-	-	0.54	0.46	93	1	1.46	1.26	252	4	2.13	1.74	368	8			
	Sens. cap.	-	-	-	-	0.46	0.46	93	1	1.26	1.26	252	4	1.74	1.74	368	8			
	Water flow	-	-	-	-	93	93	252	1	1.26	1.26	252	4	1.74	1.74	368	8			
	WPD	-	-	-	-	1	0.54	0.54	1	1.46	1.26	252	4	1.74	1.74	368	8			
8-13°C	Tot. cap.	-	-	-	-	0.48	0.43	83	1	1.23	1.17	213	3	1.83	1.61	315	6			
	Sens. cap.	-	-	-	-	0.43	0.43	83	1	1.17	1.17	213	3	1.61	1.61	315	6			
	Water flow	-	-	-	-	83	83	213	1	1.17	1.17	213	3	1.61	1.61	315	6			
	WPD	-	-	-	-	1	0.48	0.48	1	1.23	1.17	213	3	1.61	1.61	315	6			
26°C / 50%	5-10°C	Tot. cap.	-	-	-	0.83	0.58	143	2	2.58	1.73	445	10	3.49	2.31	602	19			
		Sens. cap.	-	-	-	-	0.58	0.55	120	2	1.73	1.61	360	7	2.31	2.18	500	13		
		Water flow	-	-	-	-	143	120	360	2	1.61	1.61	360	7	2.18	2.18	500	13		
		WPD	-	-	-	-	2	0.77	0.77	2	2.30	1.61	360	7	2.18	2.18	500	13		
	5.5-11°C	Tot. cap.	-	-	-	-	0.77	0.55	120	2	2.30	1.61	360	7	2.18	2.18	500	13		
		Sens. cap.	-	-	-	-	0.55	0.55	120	2	1.61	1.61	360	7	2.18	2.18	500	13		
		Water flow	-	-	-	-	120	120	360	2	1.61	1.61	360	7	2.18	2.18	500	13		
		WPD	-	-	-	-	2	0.77	0.77	2	2.30	1.61	360	7	2.18	2.18	500	13		
	6-12°C	Tot. cap.	-	-	-	-	0.70	0.52	101	1	1.96	1.46	282	4	2.84	2.03	409	9		
		Sens. cap.	-	-	-	-	0.52	0.52	101	1	1.46	1.46	282	4	2.03	2.03	409	9		
		Water flow	-	-	-	-	101	101	282	1	1.46	1.46	282	4	2.03	2.03	409	9		
		WPD	-	-	-	-	1	0.70	0.70	1	1.96	1.46	282	4	2.03	2.03	409	9		
7-12°C	Tot. cap.	-	-	-	-	0.68	0.51	117	1	2.06	1.50	355	7	2.86	2.03	492	13			
	Sens. cap.	-	-	-	-	0.51	0.51	117	1	1.50	1.50	355	7	2.03	2.03	492	13			
	Water flow	-	-	-	-	117	117	355	1	1.50	1.50	355	7	2.03	2.03	492	13			
	WPD	-	-	-	-	1	0.68	0.68	1	2.06	1.50	355	7	2.03	2.03	492	13			
8-13°C	Tot. cap.	-	-	-	-	0.61	0.48	105	1	1.78	1.39	307	5	2.52	1.89	434	10			
	Sens. cap.	-	-	-	-	0.48	0.48	105	1	1.39	1.39	307	5	1.89	1.89	434	10			
	Water flow	-	-	-	-	105	105	307	1	1.39	1.39	307	5	1.89	1.89	434	10			
	WPD	-	-	-	-	1	0.61	0.61	1	1.78	1.39	307	5	1.89	1.89	434	10			
28°C / 50%	5-10°C	Tot. cap.	-	-	-	1.06	0.67	182	3	3.16	1.96	545	14	4.21	2.59	726	26			
		Sens. cap.	-	-	-	-	0.67	0.61	146	2	1.96	1.85	458	10	2.59	2.47	617	20		
		Water flow	-	-	-	-	182	146	458	3	1.85	1.85	458	10	2.47	2.47	617	20		
		WPD	-	-	-	-	3	1.06	1.06	3	3.16	1.96	545	14	2.47	2.47	617	20		
	5.5-11°C	Tot. cap.	-	-	-	-	0.93	0.61	146	2	2.92	1.85	458	10	3.94	2.47	617	20		
		Sens. cap.	-	-	-	-	0.61	0.61	146	2	1.85	1.85	458	10	2.47	2.47	617	20		
		Water flow	-	-	-	-	146	146	458	2	1.85	1.85	458	10	2.47	2.47	617	20		
		WPD	-	-	-	-	2	0.93	0.93	2	2.92	1.85	458	10	2.47	2.47	617	20		
	6-12°C	Tot. cap.	-	-	-	-	0.86	0.58	124	1	2.65	1.73	380	7	3.64	2.33	523	15		
		Sens. cap.	-	-	-	-	0.58	0.58	124	1	1.73	1.73	380	7	2.33	2.33	523	15		
		Water flow	-	-	-	-	124	124	380	1	1.73	1.73	380	7	2.33	2.33	523	15		
		WPD	-	-	-	-	1	0.86	0.86	1	2.65	1.73	380	7	2.33	2.33	523	15		
7-12°C	Tot. cap.	-	-	-	-	0.84	0.57	145	2	2.68	1.75	462	11	3.61	2.32	622	20			
	Sens. cap.	-	-	-	-															

Cooling Capacities - FED

Correction factors to be applied on the above values

Unit size	100	200	300	400
Voltage (V)				
Speed 1	-	2.3	2.6	2.5
Speed 2	-	3.0	3.6	3.3
Speed 3	-	3.7	4.6	4.1
Speed 4	-	4.4	5.6	4.9
Speed 5	-	5.1	6.6	5.7
Speed 6	-	5.8	7.6	6.7
Airflow rate (m3/h) / ESP (Pa)				
Speed 1	-	43 / 9	108 / 7	144 / 8
Speed 2	-	57 / 16	159 / 14	197 / 14
Speed 3	-	72 / 25	208 / 24	253 / 24
Speed 4	-	87 / 36	255 / 36	310 / 35
Speed 5	-	102 / 50	299 / 50	368 / 50
Speed 6	-	117 / 66	341 / 65	440 / 71
Total cooling capacity				
Speed 1	-	0.51	0.39	0.38
Speed 2	-	0.62	0.51	0.48
Speed 3	-	0.73	0.62	0.62
Speed 4	-	0.83	0.77	0.75
Speed 5	-	0.92	0.89	0.87
Speed 6	-	1.00	1.00	1.00
Sensible cooling capacity				
Speed 1	-	0.45	0.37	0.36
Speed 2	-	0.57	0.50	0.48
Speed 3	-	0.68	0.63	0.61
Speed 4	-	0.79	0.76	0.74
Speed 5	-	0.90	0.89	0.86
Speed 6	-	1.00	1.00	1.00

Heating Capacities - FCD

Table 23 - Heating capacities, 2-pipe coil, 0Pa
Unit with rectangular flange at the discharge side and EU3 filter, no inlet air connection

Unit size			101	103	203	204	304	306	406	408	508	512	612	616	716	724	
Return air temperature 20°C 2-pipe coil		Airflow	m3/h	227	313	380	465	501	695	697	1092	1286	1419	1541	2117	2169	2677
	50-45°C	Capacity	kW	1.7	2.2	2.7	3.1	4.0	5.3	5.6	8.0	7.9	8.5	11.0	14.0	15.2	17.9
		Water flow	l/h	293	368	460	529	688	899	956	1364	1336	1433	1872	2380	2583	3019
		WPD	Pa	21	32	12	16	22	36	35	68	88	100	52	80	69	92
	60-50°C	Capacity	kW	2.2	2.8	3.4	3.9	5.2	6.7	7.2	10.2	10.0	10.7	14.0	17.8	19.4	22.6
		Water flow	l/h	187	234	291	334	441	573	613	870	847	908	1195	1514	1647	1922
		WPD	Pa	9	14	5	7	10	16	16	30	38	44	23	35	30	40
	70-60°C	Capacity	kW	2.8	3.6	4.4	5.1	6.6	8.7	9.2	13.1	12.9	13.8	18.0	22.9	24.9	29.1
		Water flow	l/h	241	302	378	435	567	739	787	1122	1096	1176	1539	1954	2123	2480
		WPD	Pa	15	22	9	11	15	25	25	47	61	70	36	56	48	64
	80-60°C	Capacity	kW	3.1	3.9	4.9	5.6	7.4	9.6	10.3	14.6	14.1	15.2	20.1	25.4	27.6	32.3
		Water flow	l/h	134	167	207	237	317	411	442	624	603	646	857	1083	1180	1374
		WPD	Pa	5	8	3	4	5	8	9	16	21	23	13	19	16	21
	82-71°C	Capacity	kW	3.6	4.5	5.6	6.4	8.3	10.9	11.6	16.5	16.2	17.4	22.6	28.8	31.2	36.6
		Water flow	l/h	276	346	434	499	647	844	897	1281	1254	1346	1757	2232	2423	2833
		WPD	Pa	19	28	11	14	20	32	32	60	78	89	46	71	61	82
	90-70°C	Capacity	kW	3.8	4.7	5.9	6.8	8.9	11.6	12.4	17.6	17.1	18.3	24.1	30.6	33.3	38.9
		Water flow	l/h	162	202	251	288	381	495	529	751	729	781	1030	1304	1419	1655
WPD		Pa	7	11	4	5	7	12	12	23	29	33	18	27	22	30	

Capacity Heating capacity Data given at high speed
WPD Water pressure drop

Correction factors to be applied on the above values

Unit size	101	103	203	204	304	306	406	408	508	512	612	616	716	724
Airflow rate / ESP (m³/h / Pa)														
Speed 1	63	137	163	199	207	345	348	471	495	757	772	1240	1216	1714
Speed 2	78	159	189	231	241	391	394	542	564	924	967	1409	1384	1880
Speed 3	110	189	222	327	329	502	518	794	799	1033	1108	1571	1553	2053
Speed 4	140	222	270	374	380	566	581	908	948	1220	1291	1736	1748	2277
Speed 5	188	271	321	415	438	642	642	1004	1110	1329	1411	1890	1880	2491
Speed 6	227	313	380	465	501	695	697	1092	1286	1419	1541	2117	2169	2677
Heating capacity (2-pipe)														
Speed 1	0.33	0.53	0.50	0.52	0.46	0.56	0.55	0.51	0.48	0.64	0.57	0.67	0.63	0.71
Speed 2	0.41	0.60	0.57	0.59	0.53	0.62	0.61	0.57	0.53	0.74	0.69	0.74	0.70	0.77
Speed 3	0.56	0.69	0.66	0.78	0.70	0.77	0.78	0.78	0.70	0.80	0.77	0.80	0.77	0.82
Speed 4	0.68	0.78	0.77	0.86	0.79	0.85	0.86	0.87	0.80	0.90	0.87	0.86	0.85	0.89
Speed 5	0.86	0.90	0.88	0.92	0.89	0.94	0.93	0.94	0.90	0.96	0.93	0.92	0.90	0.95
Speed 6	1.00	1.00	1.00	1.00	1.00	1.00	1.00	1.00	1.00	1.00	1.00	1.00	1.00	1.00

Heating capacities - FCD

Table 24 - Heating capacities, 4-pipe coil, 0Pa
 Unit with rectangular flange at the discharge side and EU3 filter, no inlet air connection

Unit size			101	103	203	204	304	306	406	408	508	512	612	616	716	724
	Airflow	m3/h	205	300	366	456	501	686	688	1063	1259	1363	1489	1996	2089	2573
50-45°C	Capacity	kW	0.7	0.9	1.2	1.3	1.6	1.9	2.0	2.5	4.0	4.2	5.1	6.0	5.8	6.5
	Water flow	l/h	123	145	190	210	265	305	326	399	661	688	851	985	950	1052
	WPD	Pa	1	1	3	4	14	20	13	19	84	91	155	204	188	227
60-50°C	Capacity	kW	0.9	1.0	1.4	1.5	1.9	2.3	2.4	3.0	4.9	5.1	6.3	7.4	7.1	8.0
	Water flow	l/h	71	85	114	126	162	186	200	246	411	428	531	614	593	657
	WPD	Pa	0	1	1	2	4	6	6	8	36	39	64	84	78	94
70-60°C	Capacity	kW	1.2	1.4	1.8	2.0	2.6	3.0	3.2	3.9	6.4	6.7	8.2	9.6	9.2	10.3
	Water flow	l/h	100	118	155	171	216	249	266	325	539	561	694	803	775	858
	WPD	Pa	1	1	2	3	9	12	10	13	59	63	106	139	128	155
80-60°C	Capacity	kW	1.1	1.4	1.9	2.1	2.7	3.1	3.3	4.1	6.9	7.2	8.9	10.3	10.0	11.1
	Water flow	l/h	47	56	78	86	112	130	140	171	289	301	374	434	419	464
	WPD	Pa	0	0	1	1	2	3	3	5	20	21	33	44	40	49
82-71°C	Capacity	kW	1.5	1.8	2.4	2.6	3.3	3.8	4.0	5.0	8.1	8.4	10.4	12.0	11.6	13.0
	Water flow	l/h	118	139	181	200	250	289	307	377	621	646	798	923	890	986
	WPD	Pa	1	1	3	4	13	18	12	17	75	81	138	181	166	201
90-70°C	Capacity	kW	1.5	1.8	2.3	2.6	3.3	3.8	4.1	5.1	8.3	8.7	10.7	12.5	12.1	13.5
	Water flow	l/h	62	74	99	109	139	161	172	211	352	367	454	526	508	563
	WPD	Pa	0	0	1	1	3	4	5	7	28	30	48	63	58	70

Capacity Heating capacity Data given at high speed
 WPD Water pressure drop

Correction factors to be applied on the above values

Unit size	101	103	203	204	304	306	406	408	508	512	612	616	716	724
Airflow rate / ESP (m³/h / Pa)														
Speed 1	64	126	148	199	207	341	343	459	482	739	757	1210	1197	1688
Speed 2	72	149	174	232	241	386	389	531	551	898	943	1369	1361	1845
Speed 3	103	182	209	334	329	496	512	776	786	1005	1079	1514	1519	2009
Speed 4	131	217	251	375	380	559	574	887	932	1178	1254	1662	1702	2217
Speed 5	172	260	309	410	438	633	634	979	1091	1278	1367	1801	1828	2412
Speed 6	205	300	366	456	501	686	688	1063	1259	1363	1489	1996	2089	2573
Heating capacity (4-pipe)														
Speed 1	0.57	0.67	0.66	0.69	0.67	0.72	0.73	0.68	0.63	0.74	0.72	0.78	0.77	0.81
Speed 2	0.61	0.72	0.72	0.73	0.72	0.76	0.77	0.72	0.67	0.82	0.80	0.83	0.82	0.85
Speed 3	0.73	0.79	0.78	0.86	0.83	0.85	0.87	0.85	0.79	0.86	0.85	0.87	0.86	0.88
Speed 4	0.81	0.86	0.84	0.91	0.88	0.90	0.92	0.91	0.86	0.93	0.92	0.91	0.90	0.93
Speed 5	0.92	0.93	0.92	0.95	0.94	0.96	0.96	0.96	0.93	0.97	0.96	0.95	0.94	0.97
Speed 6	1.00	1.00	1.00	1.00	1.00	1.00	1.00	1.00	1.00	1.00	1.00	1.00	1.00	1.00

Heating Capacities - FCD

Table 25 - Heating capacities, 2-pipe coil, 50Pa in speed 5
Unit with return air duct connection D200mm, discharge air duct connection D200mm and EU3 filter(s)

Return air temperature 20°C	2-pipe coil	Unit size		101	103	203	204	304	306	406	408	508	512	612	616	716	724
		Airflow	m3/h	-	70	86	182	198	425	419	565	614	902	912	1233	1281	1973
50-45°C	Capacity	kW	-	0.7	0.8	1.5	1.8	3.6	3.7	4.8	4.5	6.1	7.2	9.3	10.0	14.2	
	Water flow	l/h	-	108	132	257	303	599	619	801	755	1026	1225	1570	1701	2402	
	WPD	Pa	-	4	1	4	5	17	16	26	31	54	24	38	32	60	
60-50°C	Capacity	kW	-	0.9	1.0	2.0	2.3	4.5	4.7	6.1	5.7	7.7	9.2	11.8	12.8	18.1	
	Water flow	l/h	-	70	84	164	195	384	399	515	482	652	786	1004	1090	1534	
	WPD	Pa	-	2	1	2	2	7	7	11	14	24	11	17	14	26	
70-60°C	Capacity	kW	-	1.1	1.3	2.5	3.0	5.8	6.0	7.8	7.3	9.9	11.8	15.1	16.4	23.2	
	Water flow	l/h	-	89	109	212	251	494	510	660	621	842	1009	1291	1400	1975	
	WPD	Pa	-	3	1	3	3	12	11	18	22	38	17	26	22	42	
80-60°C	Capacity	kW	-	1.2	1.4	2.8	3.3	6.5	6.8	8.7	8.1	11.0	13.3	16.9	18.4	25.8	
	Water flow	l/h	-	50	60	117	141	277	289	372	345	466	566	722	785	1099	
	WPD	Pa	-	1	0	1	1	4	4	6	8	13	6	9	7	14	
82-71°C	Capacity	kW	-	1.3	1.6	3.1	3.7	7.3	7.5	9.7	9.2	12.4	14.8	19.0	20.6	29.1	
	Water flow	l/h	-	101	124	242	285	563	581	752	709	963	1149	1473	1595	2254	
	WPD	Pa	-	3	1	4	4	15	14	23	28	48	21	34	28	53	
90-70°C	Capacity	kW	-	1.5	1.8	3.4	4.0	7.8	8.1	10.5	9.8	13.2	15.9	20.3	22.0	31.0	
	Water flow	l/h	-	60	73	142	170	332	345	445	416	562	678	866	941	1322	
	WPD	Pa	-	1	0	1	2	6	5	9	11	18	8	13	10	20	

Capacity Heating capacity Data given at high speed
WPD Water pressure drop

Correction factors to be applied on the above values

Unit size	101	103	203	204	304	306	406	408	508	512	612	616	716	724
Airflow rate / ESP (m³/h / Pa)														
Speed 1	-	40 / 18	50 / 19	104 / 18	107 / 16	258 / 21	256 / 20	325 / 18	316 / 15	592 / 23	581 / 22	962 / 33	981 / 31	1510 / 31
Speed 2	-	46 / 24	57 / 25	121 / 24	123 / 22	282 / 25	287 / 26	371 / 23	360 / 19	686 / 32	680 / 31	1040 / 39	1080 / 38	1609 / 35
Speed 3	-	52 / 32	67 / 34	153 / 39	159 / 36	343 / 37	354 / 39	481 / 39	488 / 35	757 / 38	750 / 37	1089 / 42	1135 / 42	1707 / 40
Speed 4	-	59 / 40	73 / 40	163 / 44	174 / 44	371 / 43	379 / 45	519 / 45	540 / 43	826 / 46	826 / 45	1136 / 46	1199 / 47	1820 / 45
Speed 5	-	65 / 50	81 / 50	174 / 50	187 / 50	402 / 50	400 / 50	554 / 50	585 / 50	864 / 50	869 / 50	1184 / 50	1237 / 50	1911 / 50
Speed 6	-	70 / 57	86 / 57	182 / 55	198 / 56	425 / 56	419 / 55	565 / 54	614 / 55	902 / 54	912 / 55	1233 / 54	1281 / 54	1973 / 53
Heating capacity (2-pipe)														
Speed 1	-	0.57	0.58	0.60	0.56	0.64	0.64	0.61	0.57	0.72	0.68	0.82	0.80	0.81
Speed 2	-	0.65	0.66	0.68	0.64	0.69	0.71	0.69	0.64	0.81	0.78	0.87	0.87	0.85
Speed 3	-	0.74	0.77	0.84	0.81	0.83	0.85	0.87	0.82	0.87	0.85	0.90	0.90	0.89
Speed 4	-	0.83	0.83	0.90	0.88	0.89	0.91	0.93	0.90	0.93	0.92	0.93	0.94	0.94
Speed 5	-	0.93	0.93	0.95	0.94	0.95	0.96	0.97	0.96	0.97	0.96	0.97	0.97	0.97
Speed 6	-	1.00	1.00	1.00	1.00	1.00	1.00	1.00	1.00	1.00	1.00	1.00	1.00	1.00

Heating capacities - FCD

Table 26 - Heating capacities, 4-pipe coil, 50Pa in speed 5
Unit with return air duct connection D200mm, discharge air duct connection D200mm and EU3 filter(s)

Return air temperature 20°C 4-pipe (heating coil)	Unit size		101	103	203	204	304	306	406	408	508	512	612	616	716	724
	Airflow	m3/h	-	71	83	172	198	418	412	553	605	868	886	1178	1228	1912
50-45°C	Capacity	kW	-	0.5	0.6	0.8	1.1	1.5	1.6	1.8	2.8	3.3	4.0	4.6	4.5	5.6
	Water flow	l/h	-	74	95	137	177	245	262	296	468	554	665	760	744	911
	WPD	Pa	-	0	1	2	5	12	9	11	46	62	98	126	119	173
60-50°C	Capacity	kW	-	0.5	0.7	1.0	1.3	1.8	2.0	2.2	3.5	4.1	5.0	5.7	5.6	6.9
	Water flow	l/h	-	42	57	82	108	150	161	182	291	344	415	475	465	568
	WPD	Pa	-	0	0	1	2	4	4	5	20	27	40	52	49	72
70-60°C	Capacity	kW	-	0.8	1.0	1.3	1.7	2.4	2.6	2.9	4.5	5.4	6.4	7.4	7.2	8.9
	Water flow	l/h	-	60	78	112	144	199	213	241	382	451	542	620	607	743
	WPD	Pa	-	0	1	1	3	7	7	8	32	43	67	86	81	118
80-60°C	Capacity	kW	-	0.7	0.9	1.3	1.8	2.5	2.7	3.1	4.9	5.7	6.9	7.9	7.8	9.6
	Water flow	l/h	-	27	38	55	75	104	112	127	204	241	291	333	327	401
	WPD	Pa	-	0	0	0	1	2	2	3	11	14	21	27	25	37
82-71°C	Capacity	kW	-	1.0	1.2	1.7	2.2	3.0	3.2	3.7	5.7	6.8	8.1	9.3	9.1	11.2
	Water flow	l/h	-	72	91	130	167	231	247	279	439	519	622	712	697	853
	WPD	Pa	-	0	1	2	5	10	8	10	41	55	86	111	105	153
90-70°C	Capacity	kW	-	0.9	1.2	1.7	2.2	3.1	3.3	3.8	5.9	7.0	8.4	9.6	9.4	11.6
	Water flow	l/h	-	37	49	71	93	128	138	156	249	295	355	406	397	487
	WPD	Pa	-	0	0	0	1	3	3	4	15	20	30	39	37	54

Capacity Heating capacity Data given at high speed
 WPD Water pressure drop

Correction factors to be applied on the above values

Unit size	101	103	203	204	304	306	406	408	508	512	612	616	716	724	
Airflow rate / ESP (m³/h / Pa)															
Speed 1	-	39 / 17	46 / 19	100 / 18	107 / 16	254 / 21	253 / 21	319 / 18	312 / 15	577 / 24	569 / 23	933 / 34	959 / 32	1484 / 32	
Speed 2	-	46 / 23	52 / 24	113 / 23	123 / 22	279 / 25	283 / 26	364 / 23	355 / 19	666 / 32	665 / 31	1005 / 39	1052 / 39	1576 / 36	
Speed 3	-	53 / 31	60 / 32	144 / 38	159 / 36	339 / 37	349 / 39	472 / 39	481 / 35	734 / 39	733 / 37	1049 / 43	1101 / 43	1666 / 40	
Speed 4	-	60 / 41	67 / 40	157 / 45	174 / 44	366 / 37	374 / 45	508 / 45	532 / 43	797 / 46	804 / 45	1091 / 46	1160 / 47	1771 / 46	
Speed 5	-	67 / 50	75 / 50	166 / 50	187 / 50	396 / 50	394 / 50	533 / 50	577 / 50	833 / 50	846 / 50	1135 / 50	1191 / 50	1854 / 50	
Speed 6	-	71 / 56	83 / 60	172 / 54	198 / 56	418 / 56	412 / 55	553 / 54	605 / 55	868 / 54	886 / 55	1178 / 54	1228 / 53	1912 / 53	
Heating capacity (4-pipe)															
Speed 1	-	0.66	0.66	0.75	0.72	0.79	0.80	0.78	0.72	0.82	0.81	0.89	0.89	0.88	
Speed 2	-	0.74	0.73	0.81	0.78	0.83	0.84	0.82	0.77	0.88	0.87	0.92	0.93	0.91	
Speed 3	-	0.82	0.80	0.91	0.89	0.90	0.92	0.92	0.89	0.92	0.91	0.94	0.95	0.93	
Speed 4	-	0.89	0.87	0.95	0.93	0.94	0.95	0.96	0.94	0.96	0.95	0.96	0.97	0.96	
Speed 5	-	0.96	0.94	0.98	0.97	0.97	0.98	0.98	0.97	0.98	0.98	0.98	0.98	0.98	
Speed 6	-	1.00	1.00	1.00	1.00	1.00	1.00	1.00	1.00	1.00	1.00	1.00	1.00	1.00	

Heating capacities - FED

**Table 27 - Heating capacities, 2-pipe standard capacity coil, 0Pa
Unit with rectangular flange at the discharge side and EU3 filter, no inlet air connection**

Return air temperature 20°C	2-pipe coil	Unit size		100	200	300	400
		Airflow	m ³ /h	370	503	677	1069
		Voltage	V	5.1	5.8	7.6	6.7
50-45°C	Capacity	kW	2.26	3.08	4.84	7.50	
	Water flow	l/h	388	528	825	1282	
	WPD	Pa	35	16	27	61	
60-50°C	Capacity	kW	2.86	3.87	6.14	9.54	
	Water flow	l/h	245	332	525	817	
	WPD	Pa	15	7	12	27	
70-60°C	Capacity	kW	3.71	5.05	7.93	12.30	
	Water flow	l/h	318	433	679	1054	
	WPD	Pa	24	11	19	42	
80-60°C	Capacity	kW	4.07	5.48	8.77	13.64	
	Water flow	l/h	175	235	376	585	
	WPD	Pa	8	4	6	14	
82-71°C	Capacity	kW	4.68	6.39	9.97	15.46	
	Water flow	l/h	365	498	776	1204	
	WPD	Pa	31	14	24	54	
90-70°C	Capacity	kW	4.93	6.68	10.59	16.44	
	Water flow	l/h	211	286	453	704	
	WPD	Pa	12	5	9	20	

Capacity Heating capacity Data given at high speed
WPD Water pressure drop

Correction factors to be applied on the above values

Unit size	100	200	300	400
Voltage (V)				
Speed 1	2.0	2.3	2.6	2.5
Speed 2	2.6	3.0	3.6	3.3
Speed 3	3.2	3.7	4.6	4.1
Speed 4	3.8	4.4	5.6	4.9
Speed 5	4.4	5.1	6.6	5.7
Speed 6	5.1	5.8	7.6	6.7
Airflow rate (m³/h) / ESP (Pa)				
Speed 1	106	169	210	347
Speed 2	154	237	325	483
Speed 3	204	306	432	635
Speed 4	257	375	527	785
Speed 5	310	441	609	924
Speed 6	370	503	677	1069
Heating capacity (2-pipe)				
Speed 1	0.37	0.42	0.37	0.40
Speed 2	0.51	0.56	0.55	0.53
Speed 3	0.64	0.69	0.69	0.67
Speed 4	0.76	0.80	0.82	0.79
Speed 5	0.88	0.91	0.92	0.90
Speed 6	1.00	1.00	1.00	1.00

Heating capacities - FED

Table 28 - Heating capacities, 4-pipe coil, 0Pa
 Unit with rectangular flange at the discharge side and EU3 filter, no inlet air connection

Return air temperature 20°C	4-pipe coil	Unit size		100	200	300	400
		Airflow	m ³ /h	338	475	668	997
		Voltage	V	5.1	5.8	7.6	6.7
50-45°C	Capacity	kW	0.85	1.31	1.78	2.60	
	Water flow	l/h	143	221	298	436	
	WPD	Pa	1	5	12	21	
60-50°C	Capacity	kW	0.99	1.56	2.17	3.18	
	Water flow	l/h	84	133	182	268	
	WPD	Pa	1	2	4	10	
70-60°C	Capacity	kW	1.37	2.11	2.87	4.20	
	Water flow	l/h	117	180	242	355	
	WPD	Pa	1	3	7	15	
80-60°C	Capacity	kW	1.31	2.14	2.99	4.41	
	Water flow	l/h	56	91	126	187	
	WPD	Pa	0	1	2	5	
82-71°C	Capacity	kW	1.78	2.71	3.66	5.33	
	Water flow	l/h	138	210	281	412	
	WPD	Pa	1	4	10	20	
90-70°C	Capacity	kW	1.72	2.69	3.70	5.43	
	Water flow	l/h	73	115	157	230	
	WPD	Pa	0	1	3	8	

Capacity Heating capacity Data given at high speed
 WPD Water pressure drop

Correction factors to be applied on the above values

Unit size	100	200	300	400
Voltage (V)				
Speed 1	2.0	2.3	2.6	2.5
Speed 2	2.6	3.0	3.6	3.3
Speed 3	3.2	3.7	4.6	4.1
Speed 4	3.8	4.4	5.6	4.9
Speed 5	4.4	5.1	6.6	5.7
Speed 6	5.1	5.8	7.6	6.7
Airflow rate (m³/h) / ESP (Pa)				
Speed 1	106	169	210	347
Speed 2	154	237	325	483
Speed 3	204	306	432	635
Speed 4	257	375	527	785
Speed 5	310	441	609	924
Speed 6	370	503	677	1069
Heating capacity (4-pipe)				
Speed 1	0.37	0.42	0.37	0.40
Speed 2	0.51	0.56	0.55	0.53
Speed 3	0.64	0.69	0.69	0.67
Speed 4	0.76	0.80	0.82	0.79
Speed 5	0.88	0.91	0.92	0.90
Speed 6	1.00	1.00	1.00	1.00

Heating capacities - FED

Table 29 - Heating capacities, 2-pipe standard capacity coil, 50Pa in speed 5
Unit with return air duct connection D200mm, discharge air duct connection D200mm and EU3 filter(s)

Return air temperature 20°C	2-pipe coil	Unit size	100	200	300	400	
		Airflow	m³/h	-	120	346	480
		Voltage	V	-	5.8	7.6	6.7
50-45°C		Capacity	kW	-	0.95	2.83	3.83
		Water flow	l/h	-	162	482	653
		WPD	Pa	-	2	10	18
60-50°C		Capacity	kW	-	1.20	3.62	4.90
		Water flow	l/h	-	102	309	419
		WPD	Pa	-	1	4	8
70-60°C		Capacity	kW	-	1.56	4.65	6.29
		Water flow	l/h	-	134	397	538
		WPD	Pa	-	1	7	12
80-60°C		Capacity	kW	-	1.70	5.20	7.05
		Water flow	l/h	-	73	222	302
		WPD	Pa	-	0	2	4
82-71°C		Capacity	kW	-	1.97	5.83	7.88
		Water flow	l/h	-	153	453	613
		WPD	Pa	-	2	9	16
90-70°C		Capacity	kW	-	2.09	6.25	8.46
		Water flow	l/h	-	89	267	362
		WPD	Pa	-	1	3	6

Capacity Heating capacity Data given at high speed
WPD Water pressure drop

Correction factors to be applied on the above values

Unit size	100	200	300	400
	Voltage (V)			
Speed 1	-	2.3	2.6	2.5
Speed 2	-	3.0	3.6	3.3
Speed 3	-	3.7	4.6	4.1
Speed 4	-	4.4	5.6	4.9
Speed 5	-	5.1	6.6	5.7
Speed 6	-	5.8	7.6	6.7
	Airflow rate (m³/h) / ESP (Pa)			
Speed 1	-	42 / 8	109 / 6	166 / 8
Speed 2	-	57 / 15	163 / 14	220 / 15
Speed 3	-	73 / 25	213 / 24	280 / 24
Speed 4	-	88 / 36	260 / 36	342 / 36
Speed 5	-	104 / 50	305 / 50	405 / 50
Speed 6	-	120 / 66	346 / 65	480 / 71
	Heating capacity (2-pipe)			
Speed 1	-	0.37	0.34	0.38
Speed 2	-	0.50	0.50	0.50
Speed 3	-	0.63	0.65	0.62
Speed 4	-	0.76	0.77	0.74
Speed 5	-	0.88	0.89	0.86
Speed 6	-	1.00	1.00	1.00

Heating capacities - FED

Table 30 - Heating capacities, 4-pipe coil, 50Pa in speed 5
 Unit with return air duct connection D200mm, discharge air duct connection D200mm and EU3 filter(s)

Return air temperature 20°C	4-pipe coil	Unit size		100	200	300	400
		Airflow	m ³ /h	-	117	341	440
		Voltage		V	5.8	7.6	6.7
50-45°C		Capacity	kW	-	0.69	1.32	1.79
		Water flow	l/h	-	117	222	300
		WPD	Pa	-	1	6	12
60-50°C		Capacity	kW	-	0.83	1.61	2.19
		Water flow	l/h	-	70	136	184
		WPD	Pa	-	0	2	5
70-60°C		Capacity	kW	-	1.12	2.13	2.89
		Water flow	l/h	-	96	181	245
		WPD	Pa	-	1	4	8
80-60°C		Capacity	kW	-	1.11	2.22	3.02
		Water flow	l/h	-	47	94	128
		WPD	Pa	-	0	1	3
82-71°C		Capacity	kW	-	1.44	2.72	3.67
		Water flow	l/h	-	112	210	283
		WPD	Pa	-	1	5	11
90-70°C		Capacity	kW	-	1.43	2.75	3.73
		Water flow	l/h	-	61	116	158
		WPD	Pa	-	0	1	4

Capacity Heating capacity Data given at high speed
 WPD Water pressure drop

Correction factors to be applied on the above values

Unit size	100	200	300	400
	Voltage (V)			
Speed 1	-	2.3	2.6	2.5
Speed 2	-	3.0	3.6	3.3
Speed 3	-	3.7	4.6	4.1
Speed 4	-	4.4	5.6	4.9
Speed 5	-	5.1	6.6	5.7
Speed 6	-	5.8	7.6	6.7
	Airflow rate (m³/h) / ESP (Pa)			
Speed 1	-	43 / 9	108 / 7	144 / 8
Speed 2	-	57 / 16	159 / 14	197 / 14
Speed 3	-	72 / 25	208 / 24	253 / 24
Speed 4	-	87 / 36	255 / 36	310 / 35
Speed 5	-	102 / 50	299 / 50	368 / 50
Speed 6	-	117 / 66	341 / 65	440 / 71
	Heating capacity (4-pipe)			
Speed 1	-	0.53	0.58	0.58
Speed 2	-	0.65	0.71	0.68
Speed 3	-	0.76	0.80	0.77
Speed 4	-	0.85	0.88	0.85
Speed 5	-	0.93	0.94	0.92
Speed 6	-	1.00	1.00	1.00

External static pressure and airflow curves

Figure 19 - External Static Pressure - FCD 101

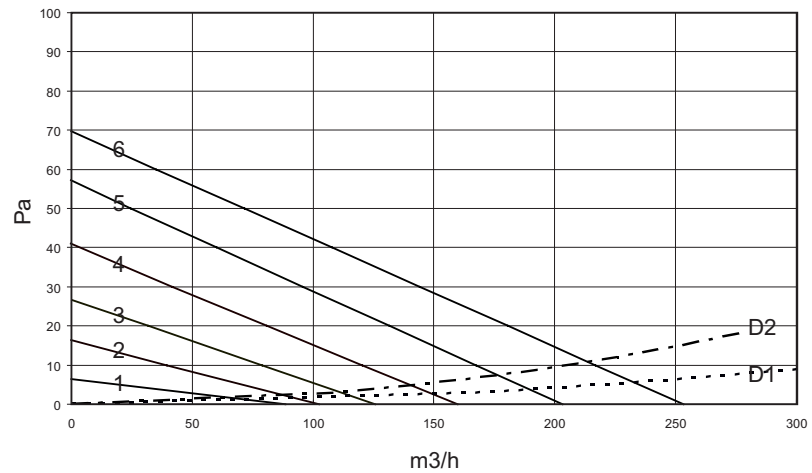

D1 = ø 200mm discharge air duct connection(s)
D2 = ø 200mm discharge and return air duct connection(s)

Figure 20 - External Static Pressure - FCD 103

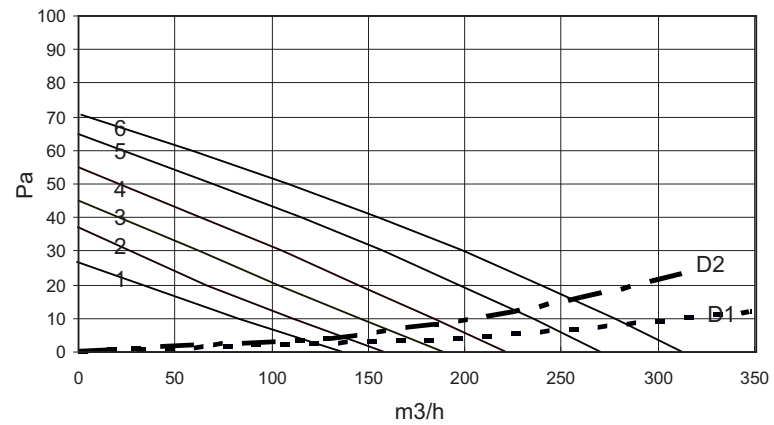

D1 = ø 200mm discharge air duct connection(s)
D2 = ø 200mm discharge and return air duct connection(s)

External static pressure and airflow curves

Figure 21 - External Static Pressure - FCD 203

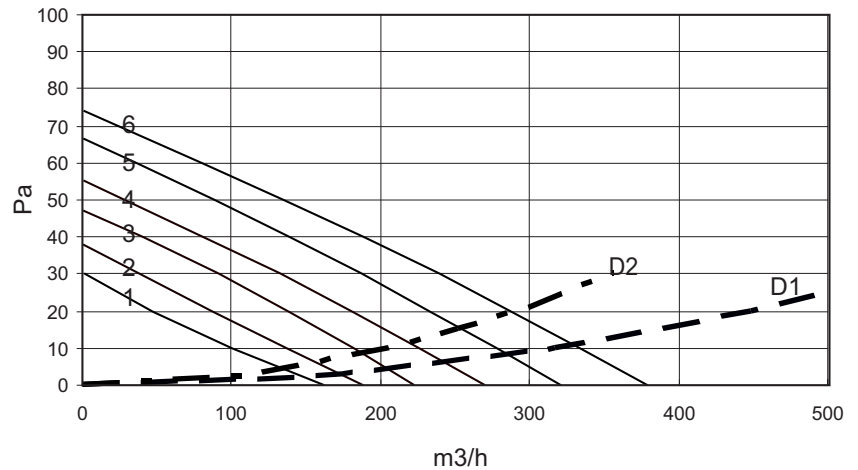

D1 = \varnothing 200mm discharge air duct connection(s)
D2 = \varnothing 200mm discharge and return air duct connection(s)

Figure 22 - External Static Pressure - FCD 204

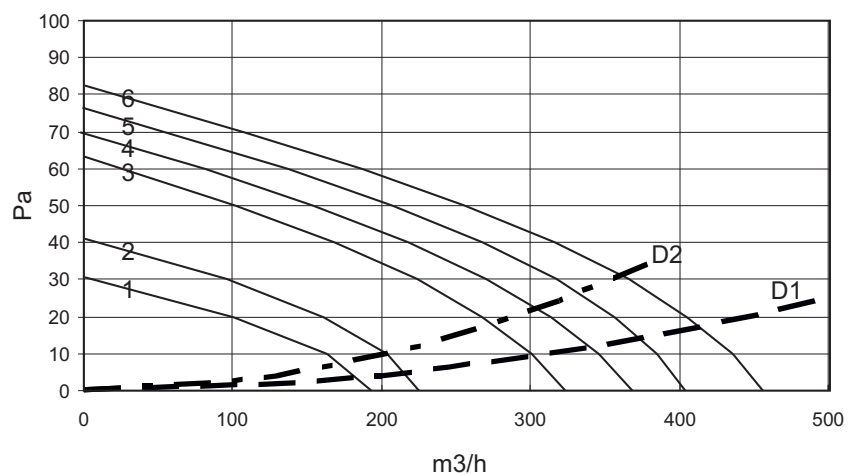

D1 = \varnothing 200mm discharge air duct connection(s)
D2 = \varnothing 200mm discharge and return air duct connection(s)

External static pressure and airflow curves

Figure 23 - External Static Pressure - FCD 304

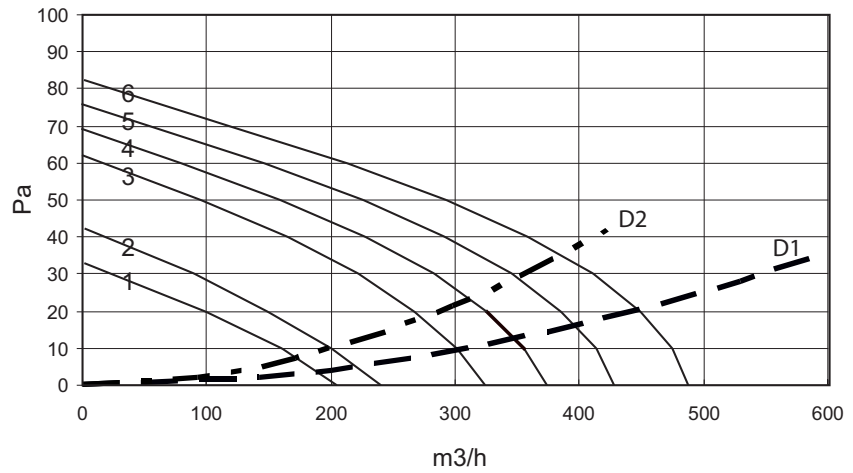

D1 = \varnothing 200mm discharge air duct connection(s)
D2 = \varnothing 200mm discharge and return air duct connection(s)

Figure 24 - External Static Pressure - FCD 306

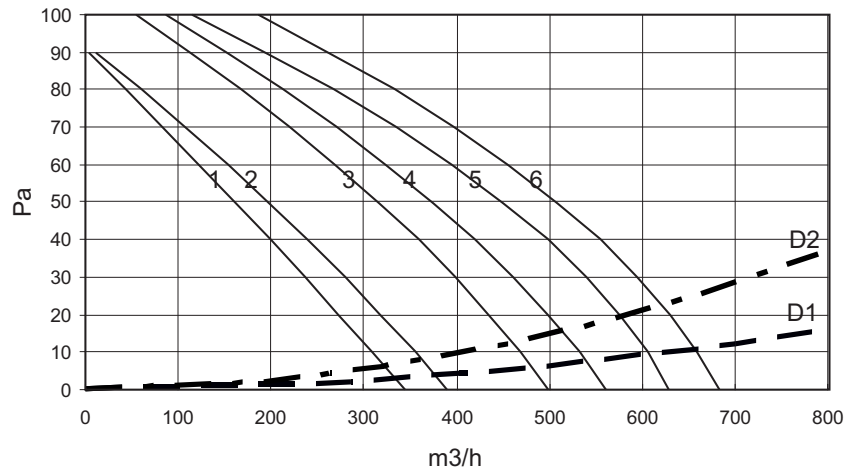

D1 = \varnothing 200mm discharge air duct connection(s)
D2 = \varnothing 200mm discharge and return air duct connection(s)

External static pressure and airflow curves

Figure 25 - External Static Pressure - FCD 406

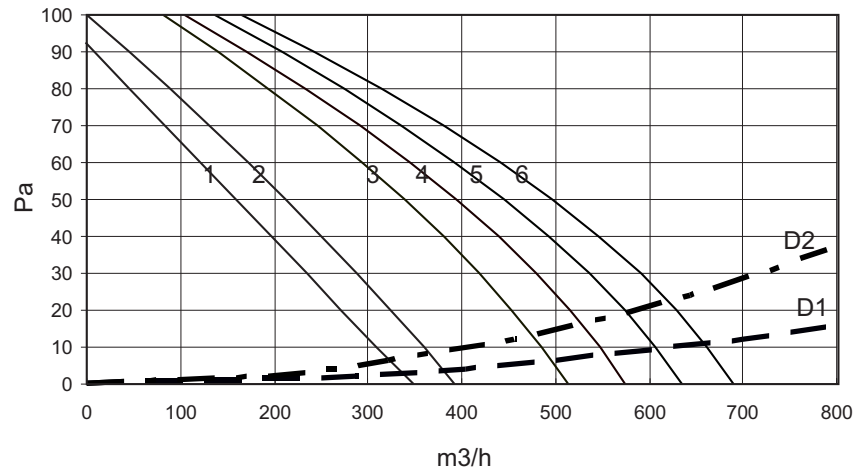

D1 = \varnothing 200mm discharge air duct connection(s)
D2 = \varnothing 200mm discharge and return air duct connection(s)

Figure 26 - External Static Pressure - FCD 408

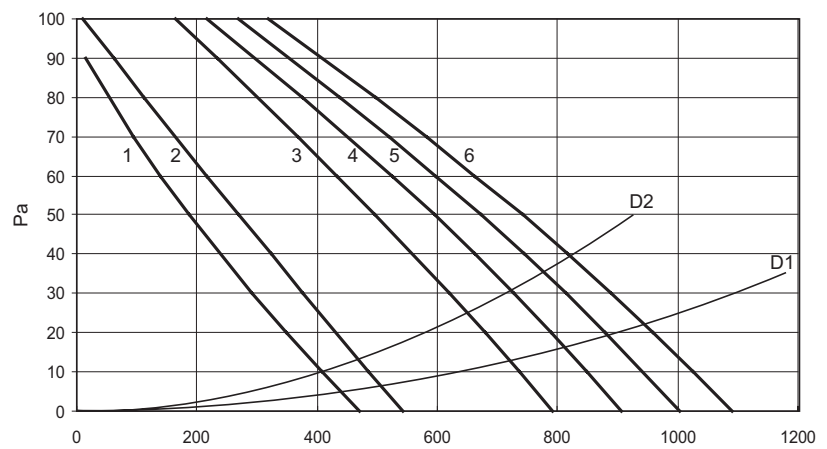

D1 = \varnothing 200mm discharge air duct connection(s)
D2 = \varnothing 200mm discharge and return air duct connection(s)

External static pressure and airflow curves

Figure 27 - External Static Pressure - FCD 508

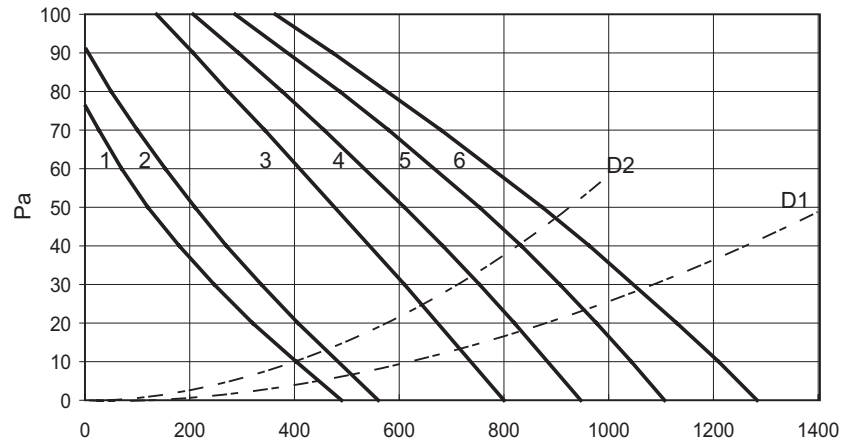

D1 = \varnothing 200mm discharge air duct connection(s)
D2 = \varnothing 200mm discharge and return air duct connection(s)

Figure 28 - External Static Pressure - FCD 512

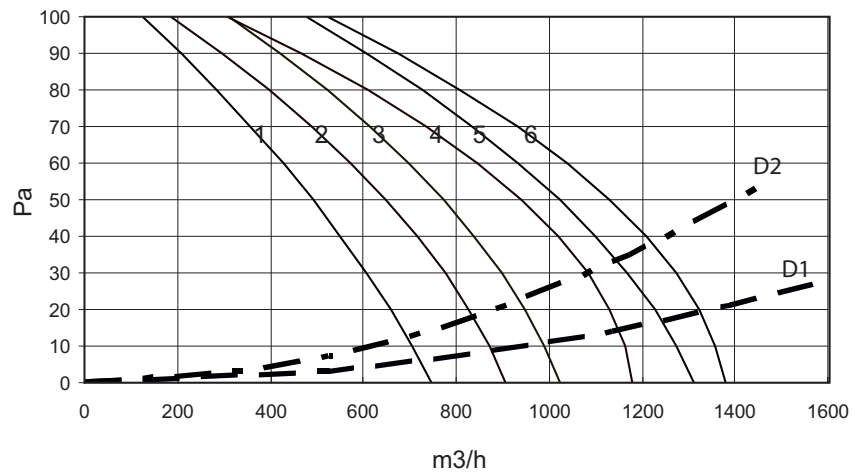

D1 = \varnothing 200mm discharge air duct connection(s)
D2 = \varnothing 200mm discharge and return air duct connection(s)

External static pressure and airflow curves

Figure 29 - External Static Pressure - FCD 612

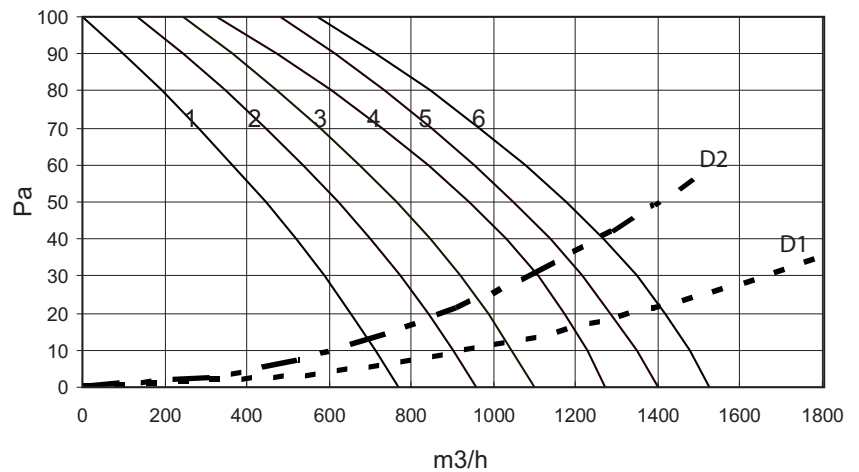

D1 = \varnothing 200mm discharge air duct connection(s)
D2 = \varnothing 200mm discharge and return air duct connection(s)

Figure 30 - External Static Pressure - FCD 616

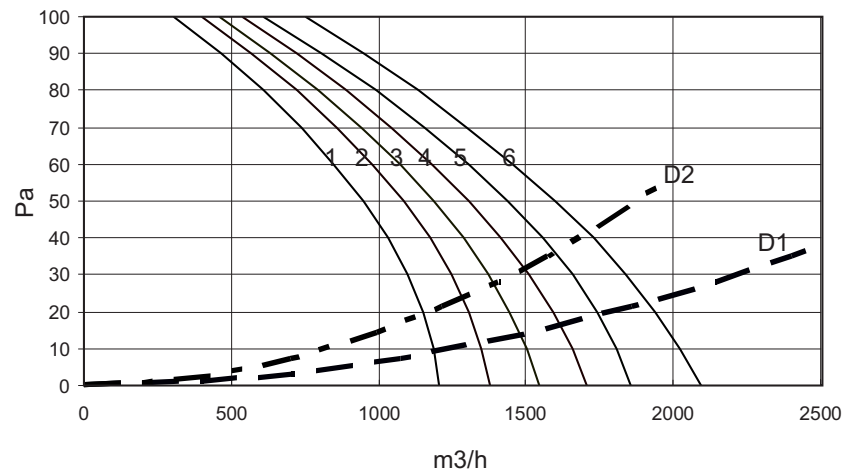

D1 = \varnothing 200mm discharge air duct connection(s)
D2 = \varnothing 200mm discharge and return air duct connection(s)

External static pressure and airflow curves

Figure 31 - External Static Pressure - FCD 716

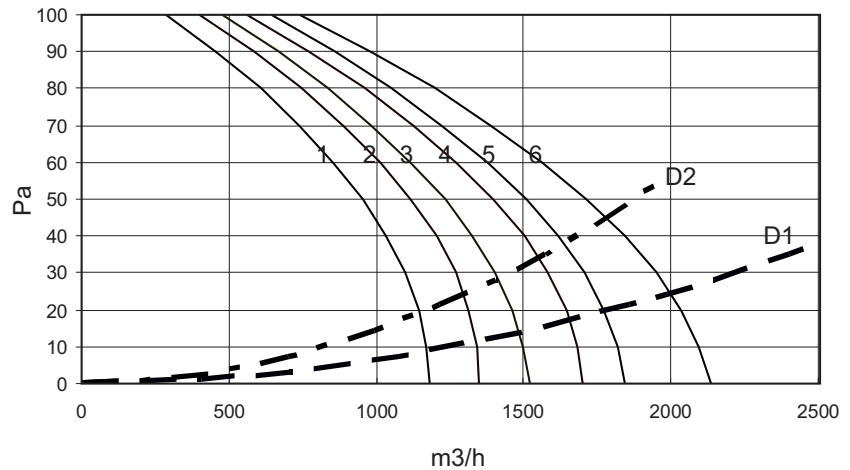

D1 = \varnothing 200mm discharge air duct connection(s)
D2 = \varnothing 200mm discharge and return air duct connection(s)

Figure 32 - External Static Pressure - FCD 724

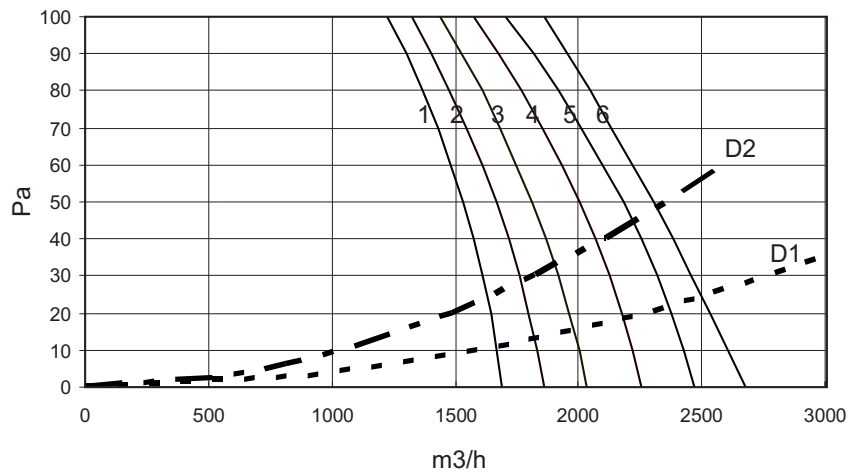

D1 = \varnothing 200mm discharge air duct connection(s)
D2 = \varnothing 200mm discharge and return air duct connection(s)

External static pressure and airflow curves

Figure 33 - External Static Pressure - FED 100

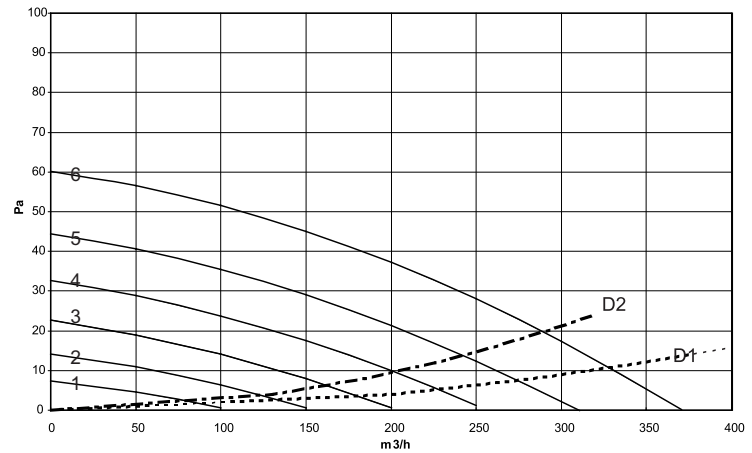

D1 = ø 200mm discharge air duct connection(s)
D2 = ø 200mm discharge and return air duct connection(s)

Figure 34 - External Static Pressure - FED 200

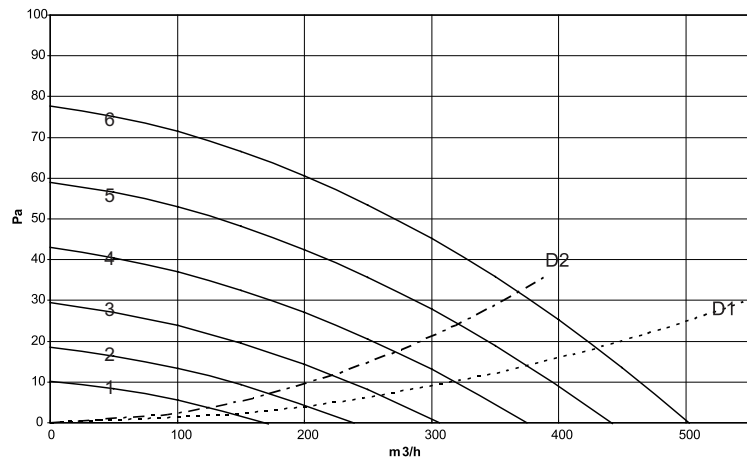

D1 = ø 200mm discharge air duct connection(s)
D2 = ø 200mm discharge and return air duct connection(s)

External static pressure and airflow curves

Figure 35 - External Static Pressure - FED 300

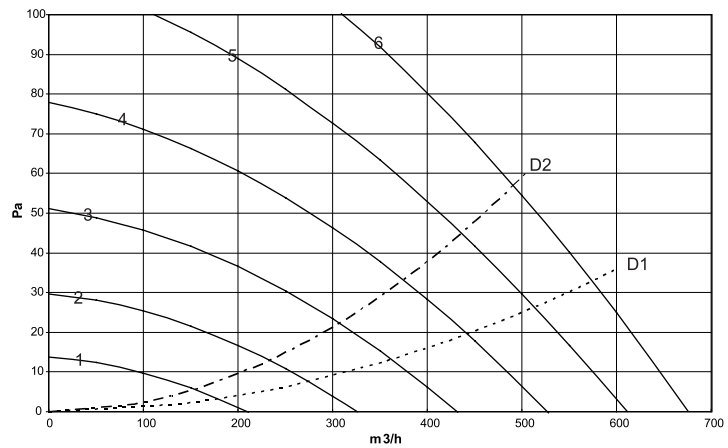

D1 = \varnothing 200mm discharge air duct connection(s)
D2 = \varnothing 200mm discharge and return air duct connection(s)

Figure 36 - External Static Pressure - FED 400

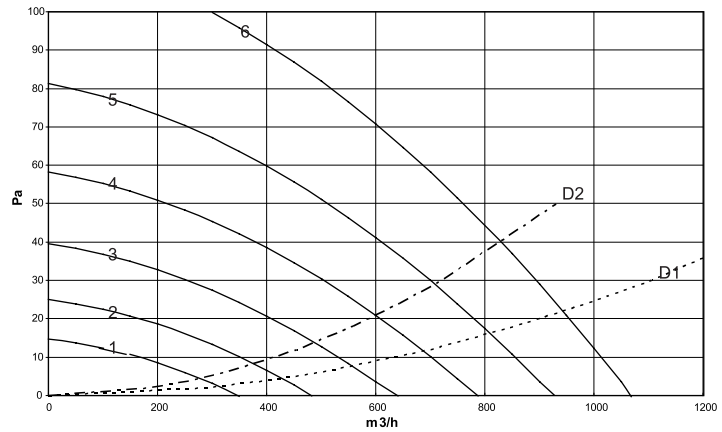

D1 = \varnothing 200mm discharge air duct connection(s)
D2 = \varnothing 200mm discharge and return air duct connection(s)

Water pressure drop curves

Figure 37 - Water pressure drop through the coils - Cooling mode, Standard 2-pipe coil

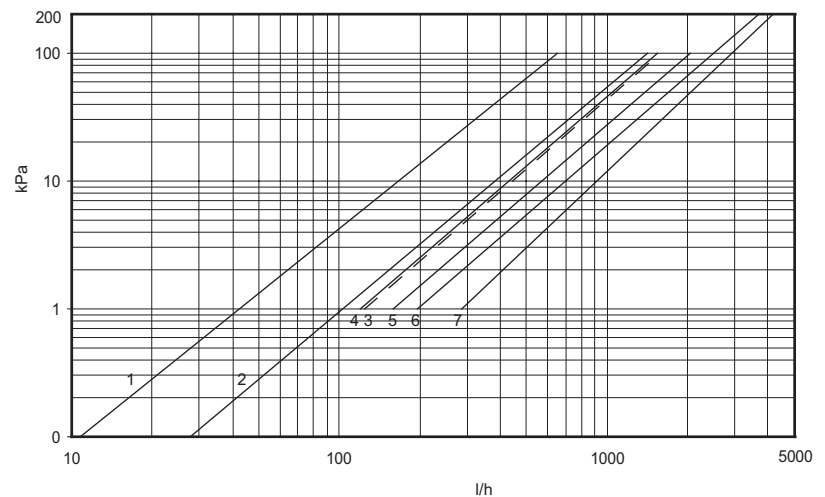

- 1 = FCD Size 101-103 / FED 100
- 2 = FCD Size 203-204 / FED 200
- 3 = FCD Size 304-306 / FED 300
- 4 = FCD Size 406-408 / FED 400
- 5 = Size 508-512
- 6 = Size 612-616
- 7 = Size 716-724

Figure 38 - Water pressure drop through the coils - Cooling mode, High capacity 2-pipe coil

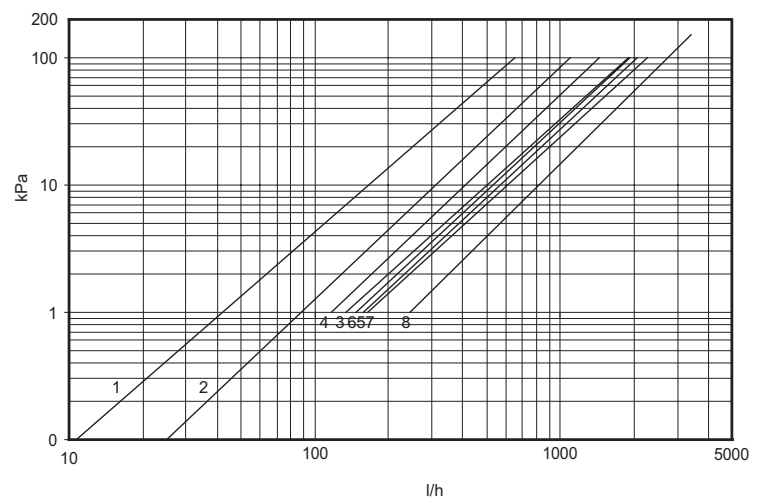

- 1 = FCD Size 101-103 / FED 100
- 2 = Size 203
- 3 = FCD Size 204 / FED 200
- 4 = FCD Size 304-306 / FED 300
- 5 = FCD Size 406-408 / FED 400
- 6 = Size 508-512
- 7 = Size 612-616
- 8 = Size 716-724

Water pressure drop curves

Figure 39 - Water pressure drop through the coils - Heating mode, Standard 2-pipe coil

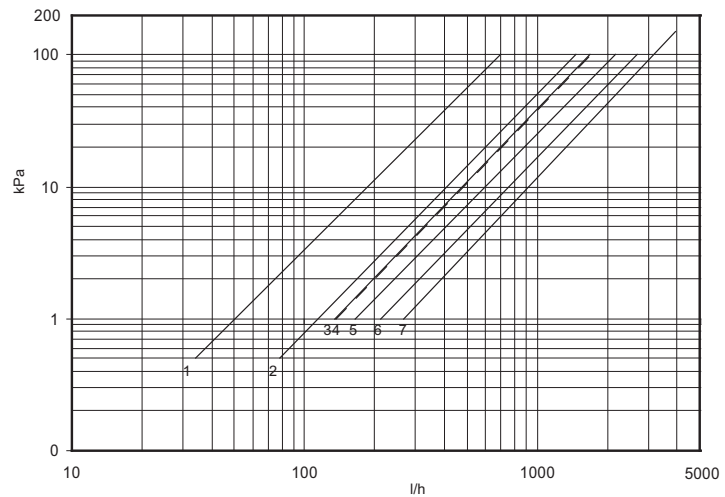

- 1 = FCD Size 101-103 / FED 100
- 2 = FCD Size 203-204 / FED 200
- 3 = FCD Size 304-306 / FED 300
- 4 = FCD Size 406-408 / FED 400
- 5 = Size 508-512
- 6 = Size 612-616
- 7 = Size 716-724

Figure 40 - Water pressure drop through the coils - Heating mode, High capacity 2-pipe coil

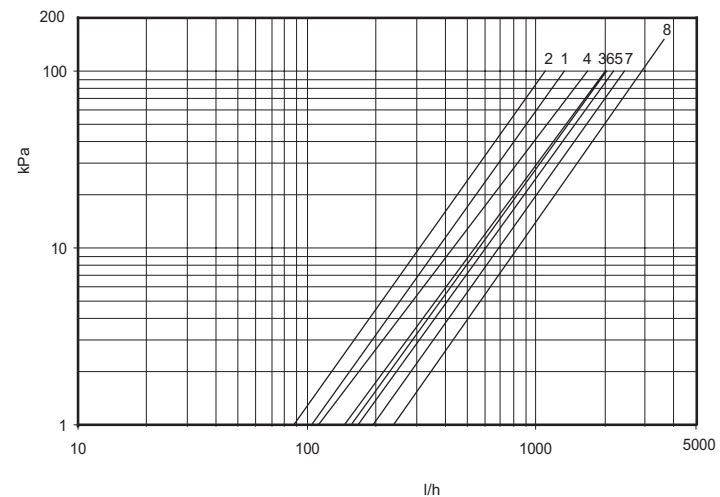

- 1 = FCD Size 101-103 / FED 100
- 2 = Size 203
- 3 = FCD Size 204 / FED 200
- 4 = FCD Size 304-306 / FED 300
- 5 = FCD Size 406-408 / FED 400
- 6 = Size 508-512
- 7 = Size 612-616
- 8 = Size 716-724

Water pressure drop curves

Figure 41 - Water pressure drop through the coils - Heating mode, Standard 4-pipe coil

For pressure drops of the 4-pipe coil in cooling mode, see Figure 42 for sizes 101-103-612-616-716-724, and Figure 44 for sizes 203-204-304-306-406-408-508-512.

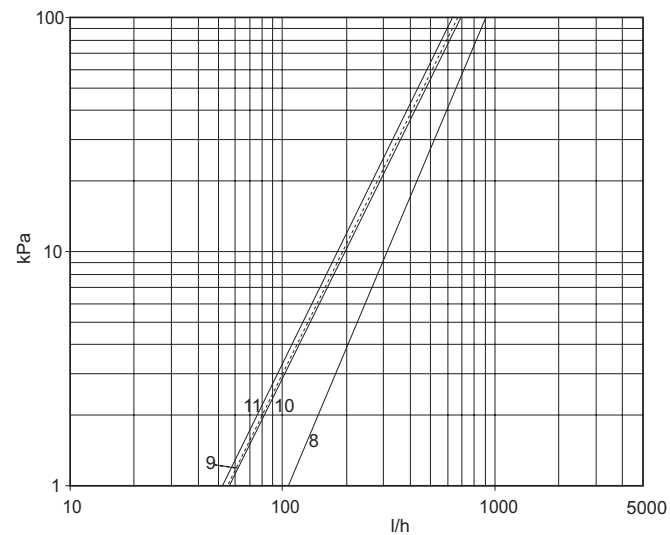
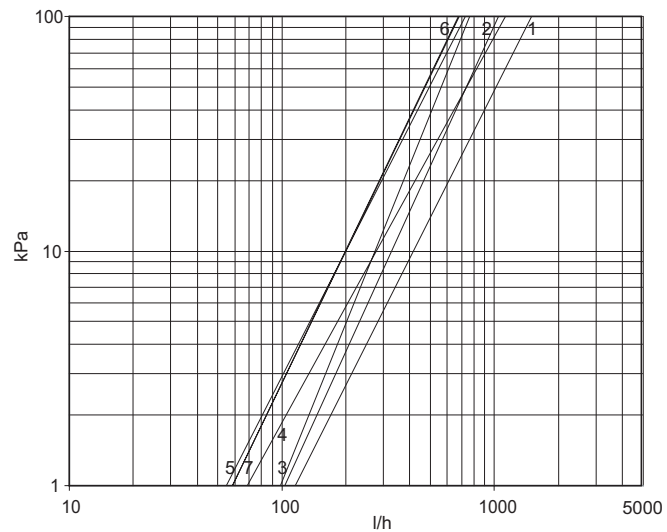

- 1 = FCD Size 101-103 Standard capacity / FED 100
- 2 = FCD Size 203-204 Standard capacity / FED 200
- 3 = FCD Size 304-306 Standard capacity / FED 300
- 4 = FCD Size 406-408 Standard capacity / FED 400
- 5 = Size 508-512 Standard capacity
- 6 = Size 612-616 Standard capacity
- 7 = Size 716-724 Standard capacity
- 8 = Size 203-204 High capacity
- 9 = Size 304-306 High capacity
- 10 = Size 406-408 High capacity
- 11 = Size 508-512 High capacity

Water pressure drop curves

Table 31 - Pressure drop through the valves - FCD

Cooling / Heating - 2-pipe coil

Unit size	101/103 203/204	304/306 406/408 508/512	612/616 716/724
Connections (inches)	1/2	1/2	3/4
2-way on/off control Kv valve	1.6	1.6	2.5
2-way ZN 523 control Kv valve	1.0	1.6	2.5
3-way on/off control Kv valve	1.6	1.6	2.5
3-way ZN523 control Kv valve	1.0	1.6	2.5

Heating (4-pipe coil)

Connections (inches)	1/2	1/2	1/2
2-way on/off control Kv valve	1.0	1.0	1.0
2-way ZN 523 control Kv valve	1.0	1.0	1.0
3-way on/off control Kv valve	1.0	1.0	1.0
3-way ZN523 control Kv valve	1.0	1.0	1.0

Water pressure drop curves

Table 32 - Pressure drop through the valves - FED

Cooling / Heating - 2-pipe coil

Unit size	100/200	300/400
Connections (inches)	1/2	1/2
2-way on/off control Kv valve	1.6	1.6
2-way ZN 525 control Kv valve	1.0	1.6
3-way on/off control Kv valve	1.6	1.6
3-way ZN525 control Kv valve	1.0	1.6

Heating (4-pipe coil)

Connections (inches)	1/2	1/2
2-way on/off control Kv valve	1.0	1.0
2-way ZN 525 control Kv valve	1.0	1.0
3-way on/off control Kv valve	1.0	1.0
3-way ZN525 control Kv valve	1.0	1.0

Figure 42 - Pressure drop through the valves

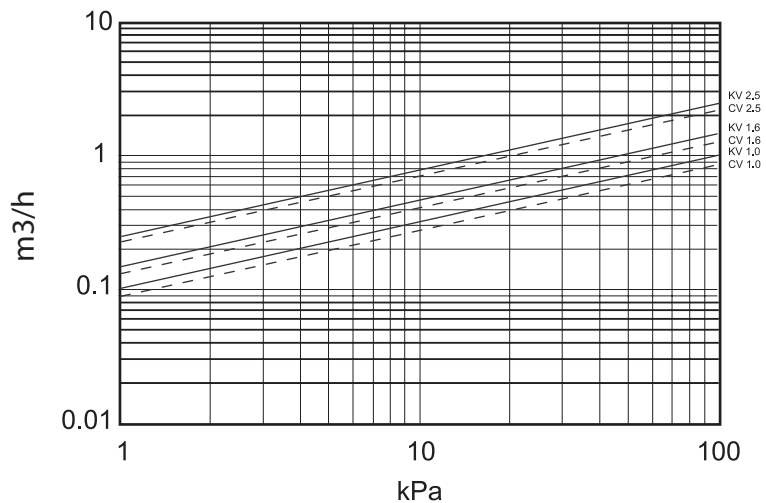

Sound Levels

**Sound levels, 2-pipe standard capacity coil, 0Pa
Unit with rectangular flange at the discharge side and EU3 filter, no inlet air connection**

Unit size	Speed	Airflow m ³ /h	ESP Pa	Sound power levels						Sound pressure levels				
				125Hz dB	250Hz dB	500Hz dB	1kHz dB	2kHz dB	4kHz dB	Global Lin dB	Global Lw dB(A)	Global Lp dB(A)	NC guide	NR guide
101	1	63	0	27	21	22	19	18	21	30	29	20	16	17
	2	78	0	28	23	24	20	19	21	31	30	21	16	17
	3	110	0	29	26	27	22	20	20	33	33	24	15	17
	4	140	0	33	32	33	27	24	21	38	38	29	18	20
	5	188	0	36	37	38	31	28	23	42	43	34	23	25
	6	227	0	40	41	43	36	32	26	47	48	39	28	30
103	1	137	0	36	40	41	36	31	23	45	41	32	26	28
	2	159	0	39	42	44	39	34	27	48	44	35	29	31
	3	189	0	42	45	47	43	38	31	51	47	38	33	34
	4	222	0	45	49	50	46	42	35	54	51	42	36	38
	5	271	0	48	51	53	49	46	39	57	54	45	39	40
	6	313	0	50	54	55	51	49	43	60	57	48	41	43
203	1	163	0	37	40	42	36	32	25	46	42	33	27	29
	2	189	0	39	42	44	38	35	28	48	44	35	29	31
	3	222	0	42	45	47	42	39	31	51	47	38	33	34
	4	270	0	44	47	50	45	42	35	54	50	41	35	37
	5	321	0	48	51	53	48	46	40	57	54	45	39	40
	6	380	0	51	53	55	51	50	46	60	57	48	41	43
204	1	199	0	37	41	40	32	21	21	45	39	30	26	27
	2	231	0	39	43	44	36	24	24	47	43	34	29	30
	3	327	0	44	48	49	44	31	31	53	49	40	35	37
	4	374	0	48	51	53	48	35	35	57	53	44	39	40
	5	415	0	54	55	55	51	40	40	60	56	47	41	43
	6	465	0	61	57	57	54	46	46	64	59	50	44	45
304	1	207	0	37	41	38	33	26	22	44	39	30	23	25
	2	241	0	39	43	40	36	30	24	46	41	32	25	27
	3	329	0	44	48	46	43	39	30	52	48	39	32	34
	4	380	0	47	50	49	46	43	34	55	51	42	36	37
	5	438	0	50	53	51	49	46	38	58	54	45	39	40
	6	501	0	55	57	55	53	51	45	61	58	49	43	45
306	1	345	0	39	42	42	39	31	22	47	43	34	29	30
	2	391	0	41	44	44	42	36	26	49	46	37	31	33
	3	502	0	49	51	50	48	47	38	56	53	44	39	41
	4	566	0	52	54	53	52	51	43	60	57	48	43	45
	5	642	0	54	57	56	55	54	48	63	60	51	45	47
	6	695	0	57	61	58	58	56	52	65	63	54	48	49
406	1	348	0	43	46	45	43	38	27	51	47	38	32	34
	2	394	0	46	48	47	45	41	31	53	49	40	34	36
	3	518	0	52	54	52	51	49	41	59	56	47	41	43
	4	581	0	54	57	55	54	52	45	62	59	50	44	46
	5	642	0	57	60	57	56	55	49	64	61	52	46	48
	6	697	0	58	62	58	58	56	52	66	63	54	48	50

Sound power levels according to Eurovent specification 8/2 (ISO 3741/88) and Eurovent Certification
Sound pressure calculated from sound power levels with an hypothetical room acoustic attenuation of 9dB

Sound Levels

**Sound levels, 2-pipe standard capacity coil, 0Pa
 Unit with rectangular flange at the discharge side and EU3 filter, no inlet air connection**

Unit size	Speed	Airflow m ³ /h	ESP Pa	Sound power levels						Sound pressure levels				
				125Hz dB	250Hz dB	500Hz dB	1kHz dB	2kHz dB	4kHz dB	Global Lin dB	Global Lw dB(A)	Global Lp dB(A)	NC guide	NR guide
408	1	471	0	37	43	44	39	29	21	48	45	36	29	31
	2	542	0	41	45	46	41	34	25	50	48	39	31	33
	3	794	0	49	51	52	48	44	35	57	55	46	38	40
	4	908	0	53	55	56	51	49	40	60	58	49	42	43
	5	1004	0	56	58	58	54	52	45	63	60	51	44	46
	6	1092	0	59	61	61	57	54	49	66	62	53	47	48
508	1	495	0	41	46	45	40	33	24	50	45	36	30	32
	2	564	0	44	48	48	43	37	28	52	48	39	33	35
	3	799	0	53	55	55	52	47	40	60	56	47	41	43
	4	948	0	56	57	57	55	51	44	63	59	50	44	46
	5	1110	0	57	59	59	57	53	47	65	61	52	46	48
	6	1286	0	59	62	61	59	56	51	67	64	55	49	50
512	1	757	0	46	48	49	43	37	27	53	52	43	35	36
	2	924	0	51	53	53	49	44	35	58	55	46	39	41
	3	1033	0	56	57	58	54	50	42	63	59	50	44	45
	4	1220	0	59	60	60	57	54	47	66	62	53	47	48
	5	1329	0	62	63	62	60	56	50	68	64	55	49	51
	6	1419	0	63	64	63	61	58	52	69	66	57	51	52
612	1	772	0	49	49	48	44	41	31	54	51	42	34	35
	2	967	0	52	53	51	47	44	36	58	55	46	37	38
	3	1108	0	56	57	55	52	48	41	62	59	50	41	43
	4	1291	0	59	61	58	55	52	46	65	62	53	45	46
	5	1411	0	62	64	61	58	55	49	68	63	54	47	49
	6	1541	0	64	66	62	60	57	52	70	64	55	49	51
616	1	1240	0	58	60	59	55	52	44	65	60	51	45	46
	2	1409	0	59	61	60	56	53	46	66	61	52	46	47
	3	1571	0	60	63	61	58	54	48	67	63	54	47	49
	4	1736	0	62	64	62	59	56	49	68	65	56	49	50
	5	1890	0	62	65	63	60	57	50	69	66	57	50	51
	6	2117	0	64	68	65	62	60	54	72	69	60	52	53
716	1	1216	0	51	51	51	47	43	33	56	54	45	37	38
	2	1384	0	54	54	54	50	47	38	60	56	47	40	41
	3	1553	0	59	58	57	54	51	44	64	60	51	44	45
	4	1748	0	62	60	59	57	54	47	66	62	53	46	48
	5	1880	0	65	63	61	59	57	51	69	64	55	49	50
	6	2169	0	68	66	64	63	60	55	72	68	59	53	54
724	1	1714	0	58	60	56	55	50	45	64	60	51	44	46
	2	1880	0	60	62	58	57	52	47	66	62	53	46	48
	3	2053	0	62	65	60	60	55	50	68	65	56	49	51
	4	2277	0	64	67	62	62	57	53	70	67	58	52	53
	5	2491	0	66	69	64	64	60	56	73	69	60	54	55
	6	2677	0	68	71	65	67	62	58	75	70	61	56	58

Sound power levels according to Eurovent specification 8/2 (ISO 3741/88) and Eurovent Certification
 Sound pressure calculated from sound power levels with an hypothetical room acoustic attenuation of 9dB

Sound Levels

**Sound levels, 4-pipe standard capacity coil, 0Pa
Unit with rectangular flange at the discharge side and EU3 filter, no inlet air connection**

Unit size	Speed	Airflow m ³ /h	ESP Pa	Sound power levels						Sound pressure levels				
				125Hz dB	250Hz dB	500Hz dB	1kHz dB	2kHz dB	4kHz dB	Global Lin dB	Global Lw dB(A)	Global Lp dB(A)	NC guide	NR guide
101	1	64	0	27	21	22	19	18	21	30	28	19	16	17
	2	72	0	28	24	25	21	19	20	32	31	22	16	17
	3	103	0	30	27	28	23	21	20	34	33	24	15	17
	4	131	0	34	34	35	29	25	21	40	40	31	20	22
	5	172	0	37	38	40	33	30	24	44	45	36	25	27
	6	205	0	41	43	45	38	35	28	49	50	41	31	32
103	1	126	0	37	41	42	37	32	24	46	42	33	27	29
	2	149	0	39	43	45	40	35	28	49	45	36	30	32
	3	182	0	42	46	48	43	39	32	52	48	39	33	35
	4	217	0	45	49	51	46	42	36	55	51	42	36	38
	5	260	0	48	52	54	49	46	40	58	54	45	39	41
	6	300	0	50	54	56	52	49	44	60	57	48	42	43
203	1	148	0	38	42	43	37	34	27	47	43	34	28	30
	2	174	0	40	44	45	40	37	29	49	45	36	31	32
	3	209	0	43	46	48	43	40	33	52	49	40	34	35
	4	251	0	46	49	51	46	44	37	55	52	43	37	38
	5	309	0	49	51	54	49	47	41	58	55	46	39	41
	6	366	0	52	54	56	52	50	47	60	57	48	42	44
204	1	199	0	37	40	40	32	21	21	45	39	30	25	27
	2	232	0	39	43	43	36	24	24	47	42	33	29	30
	3	334	0	43	48	49	43	30	30	52	48	39	34	36
	4	375	0	48	51	53	48	35	35	57	53	44	38	40
	5	410	0	54	55	56	52	41	41	60	57	48	42	43
	6	456	0	62	58	58	55	46	46	65	59	50	44	46
304	1	207	0	37	41	38	33	26	22	44	39	30	23	25
	2	241	0	39	43	40	36	30	24	46	41	32	25	27
	3	329	0	44	48	46	43	39	30	52	48	39	32	34
	4	380	0	47	50	49	46	43	34	55	51	42	36	37
	5	438	0	50	53	51	49	46	38	58	54	45	39	40
	6	501	0	55	57	55	53	51	45	61	58	49	43	45
306	1	341	0	39	43	42	40	32	23	47	43	34	29	31
	2	386	0	42	45	44	42	36	27	50	46	37	31	33
	3	496	0	49	51	51	49	47	38	57	54	45	39	41
	4	559	0	52	55	54	52	51	43	60	57	48	43	45
	5	633	0	55	58	56	55	54	48	63	60	51	46	47
	6	686	0	57	61	58	58	56	52	65	63	54	48	49
406	1	343	0	43	46	45	43	38	27	51	47	38	32	34
	2	389	0	46	49	48	45	42	32	53	50	41	35	36
	3	512	0	52	54	53	51	49	41	59	56	47	41	43
	4	574	0	55	57	55	54	52	46	62	59	50	44	46
	5	634	0	57	60	57	56	55	49	64	61	52	46	48
	6	688	0	58	62	59	58	56	52	66	63	54	48	50

Sound power levels according to Eurovent specification 8/2 (ISO 3741/88) and Eurovent Certification
Sound pressure calculated from sound power levels with an hypothetical room acoustic attenuation of 9dB

Sound Levels

**Sound levels, 4-pipe standard capacity coil, 0Pa
 Unit with rectangular flange at the discharge side and EU3 filter, no inlet air connection**

Unit size	Speed	Airflow m ³ /h	ESP Pa	Sound power levels						Sound pressure levels				
				125Hz dB	250Hz dB	500Hz dB	1kHz dB	2kHz dB	4kHz dB	Global Lin dB	Global Lw dB(A)	Global Lp dB(A)	NC guide	NR guide
408	1	459	0	38	44	44	39	30	22	48	46	37	29	31
	2	531	0	41	46	46	42	34	25	50	48	39	32	33
	3	776	0	50	52	53	48	45	36	57	55	46	39	40
	4	887	0	53	55	56	52	49	41	61	58	49	42	43
	5	979	0	57	58	59	55	53	45	64	61	52	45	46
	6	1063	0	59	61	61	57	54	49	66	62	53	47	48
508	1	482	0	42	46	46	40	33	25	50	46	37	31	33
	2	551	0	45	48	48	43	37	29	53	49	40	34	35
	3	786	0	53	55	55	52	48	40	60	57	48	41	43
	4	932	0	56	58	58	55	51	44	63	59	50	44	46
	5	1091	0	58	60	59	57	54	47	65	61	52	47	48
	6	1259	0	59	62	61	59	56	51	67	64	55	49	50
512	1	739	0	47	49	50	44	38	28	54	53	44	36	37
	2	898	0	52	53	54	49	45	36	59	56	47	40	41
	3	1005	0	57	58	58	54	50	43	63	59	50	44	45
	4	1178	0	60	61	60	58	54	47	66	62	53	47	49
	5	1278	0	62	63	62	60	56	51	68	64	55	49	51
	6	1363	0	63	64	64	61	58	53	70	66	57	51	52
612	1	757	0	49	50	48	45	41	32	55	51	42	34	36
	2	943	0	53	53	52	48	45	36	58	55	46	37	39
	3	1079	0	56	58	55	52	49	42	62	59	50	41	43
	4	1254	0	60	61	59	56	53	46	65	62	53	45	47
	5	1367	0	62	64	61	58	56	50	68	63	54	48	49
	6	1489	0	64	66	63	60	58	52	70	64	55	50	51
616	1	1210	0	59	61	59	56	52	45	65	61	52	46	47
	2	1369	0	60	62	60	57	54	47	66	62	53	47	48
	3	1514	0	61	63	62	58	55	49	68	64	55	48	49
	4	1662	0	62	65	63	60	57	50	69	66	57	49	51
	5	1801	0	63	66	64	61	58	52	70	67	58	50	52
	6	1996	0	65	68	66	63	60	55	72	70	61	53	54
716	1	1197	0	52	52	52	48	45	35	58	55	46	38	39
	2	1361	0	56	55	55	52	48	40	61	57	48	41	43
	3	1519	0	61	59	58	56	53	46	65	61	52	45	47
	4	1702	0	64	62	60	58	55	49	68	63	54	48	49
	5	1828	0	66	64	62	60	58	52	70	65	56	50	51
	6	2089	0	68	67	65	63	60	56	73	68	59	53	54
724	1	1688	0	59	61	57	56	51	46	65	61	52	45	47
	2	1845	0	61	63	59	58	54	48	67	64	55	48	49
	3	2009	0	63	66	61	61	56	51	69	66	57	50	52
	4	2217	0	65	68	63	63	58	54	71	68	59	53	54
	5	2412	0	67	70	64	65	61	57	73	69	60	55	56
	6	2573	0	68	72	66	67	63	59	75	70	61	57	58

Sound power levels according to Eurovent specification 8/2 (ISO 3741/88) and Eurovent Certification
 Sound pressure calculated from sound power levels with an hypothetical room acoustic attenuation of 9dB

Sound Levels

**Sound levels, 2-pipe standard capacity coil, 50Pa in speed 5
 Unit with return air duct connection D200mm, discharge air duct connection D200mm and EU3 filter(s)**

Unit size	Speed	Airflow ESP m ³ /h	Sound power levels												Sound pressure levels																
			Inlet						Radiated						Outlet						Unit										
			125Hz	250Hz	500Hz	1kHz	2kHz	4kHz	Global Lw	Global Lin	Global dB(A)	125Hz	250Hz	500Hz	1kHz	2kHz	4kHz	Global Lw	Global Lin	Global dB(A)	125Hz	250Hz	500Hz	1kHz	2kHz	4kHz	Global Lw	Global Lin	Global dB(A)	NC	NR
1	325	18	44	43	40	36	28	19	48	37	45	43	40	31	25	21	48	40	43	40	39	33	31	23	46	39	51	42	22	17	19
2	371	23	47	46	43	40	32	23	51	40	47	45	42	35	28	24	50	42	46	43	42	37	35	27	49	43	54	46	26	20	22
3	481	39	53	49	47	42	37	27	57	47	54	51	47	45	37	33	57	49	52	49	48	45	45	37	56	50	61	53	33	28	30
4	519	45	55	55	51	49	45	37	59	49	57	53	49	48	40	36	59	51	54	51	50	47	47	40	58	51	63	54	34	31	33
5	544	50	56	56	53	50	46	39	61	51	59	55	51	51	42	38	62	53	56	53	51	49	49	43	60	52	65	56	36	33	34
6	565	54	56	57	53	50	47	41	61	52	61	56	52	53	44	40	63	55	57	54	52	50	50	44	61	52	66	57	37	34	35
1	316	15	49	50	46	41	34	25	54	48	45	43	40	32	25	21	48	40	47	45	42	36	33	25	50	43	56	49	29	22	24
2	360	19	52	53	49	44	38	30	57	51	48	45	42	35	28	24	50	43	50	48	45	40	38	29	53	46	59	53	33	25	27
3	488	35	59	60	56	51	46	40	63	57	54	51	47	45	36	32	57	49	57	55	51	47	46	38	60	53	66	59	39	32	33
4	540	43	60	62	57	52	48	42	65	58	57	53	49	48	39	36	59	51	59	57	53	50	48	41	62	56	67	61	41	33	35
5	585	50	61	63	58	53	49	44	66	60	59	54	51	51	42	38	61	53	60	58	54	51	50	43	63	57	69	62	42	35	36
6	614	55	60	63	59	53	49	44	66	61	61	56	52	53	44	40	63	54	61	59	55	53	51	45	64	59	69	63	43	35	37
1	592	23	53	52	50	43	36	27	57	50	51	44	40	34	26	25	52	37	52	48	46	40	36	27	54	46	59	51	31	25	27
2	686	32	56	56	53	47	41	34	60	54	53	47	44	39	33	29	55	44	55	52	50	45	42	34	58	51	63	56	36	29	31
3	757	38	59	59	56	50	44	38	63	56	55	50	47	43	38	33	57	49	58	55	52	48	46	39	61	54	66	59	39	32	34
4	826	46	60	61	57	52	47	41	65	58	57	52	50	46	42	36	59	52	59	57	54	50	48	42	63	56	68	61	41	34	36
5	864	50	61	62	58	53	48	43	66	60	58	53	52	48	45	39	60	53	60	59	56	52	50	44	64	58	69	62	42	35	37
6	902	54	62	63	59	54	48	44	67	60	58	54	53	50	47	40	61	54	61	59	56	53	51	45	65	59	69	63	43	36	37
1	581	22	53	51	47	38	33	25	56	46	51	44	40	34	27	25	52	38	49	46	42	38	36	25	52	44	58	49	29	22	24
2	680	31	56	54	49	42	37	29	59	50	53	47	44	39	33	30	55	45	52	49	45	42	40	30	55	48	61	53	33	26	27
3	750	37	58	57	52	45	41	33	61	53	55	50	47	43	38	33	57	49	55	52	47	45	43	34	57	51	63	56	36	28	30
4	826	45	60	59	53	47	43	35	63	55	57	52	50	46	42	36	59	52	56	54	49	47	46	37	59	53	65	58	38	30	32
5	869	50	61	60	55	48	44	37	64	56	58	53	52	48	45	39	60	53	58	55	51	49	47	39	61	55	67	60	40	32	33
6	912	55	62	61	55	49	45	38	65	57	58	54	53	50	47	40	61	54	59	56	52	50	48	40	62	55	68	60	40	33	34
1	962	33	60	59	55	49	44	36	63	56	54	53	51	47	38	35	58	51	55	54	50	47	46	36	59	53	65	59	39	31	33
2	1040	39	60	60	56	50	45	37	64	57	55	54	52	48	40	36	59	52	56	55	51	48	47	38	60	54	66	60	40	32	34
3	1089	42	61	61	57	51	46	38	65	58	56	55	52	49	41	38	60	53	57	56	52	49	48	39	61	55	67	60	40	33	35
4	1136	46	62	62	57	52	47	39	66	59	56	55	53	49	42	39	60	54	58	57	53	50	49	40	62	56	68	61	41	34	36
5	1184	50	62	62	58	53	48	40	66	59	57	56	54	50	43	40	61	54	59	58	53	50	49	41	62	56	69	62	42	35	36
6	1233	54	63	63	59	54	49	41	67	61	58	56	54	51	44	41	62	55	59	59	54	51	50	42	63	57	69	63	43	35	37
1	981	31	60	61	58	51	46	37	65	58	54	53	50	46	38	35	58	51	54	54	48	46	43	33	58	51	67	60	40	34	36
2	1080	38	61	63	60	53	48	39	67	60	55	53	51	47	39	36	58	52	55	56	50	47	45	35	60	53	68	61	41	36	37
3	1135	42	64	65	61	55	50	42	69	62	56	54	52	48	41	38	59	53	57	58	51	49	47	37	61	54	70	63	43	37	39
4	1199	47	66	66	62	56	51	44	70	63	56	55	53	49	42	39	60	53	59	59	52	50	48	39	63	56	71	64	44	38	40
5	1237	50	67	67	63	57	52	44	71	63	57	56	53	50	42	40	61	54	60	60	53	51	49	40	64	56	72	65	45	39	40
6	1281	54	70	68	64	57	53	46	73	64	58	56	54	51	44	41	61	55	63	61	54	52	50	41	66	57	74	66	46	40	41
1	1510	31	62	57	51	49	44	38	64	55	54	53	51	47	39	35	58	51	55	54	48	48	43	36	59	52	66	58	38	31	33
2	1609	35	63	60	53	52	47	41	66	57	55	54	52	48	40	37	59	53	57	57	51	50	46	39	61	55	68	60	40	33	35
3	1707	40	65	62	54	53	49	43	67	59	56	55	53	49	41	38	60	53	58	58	52	52	48	41	63	57	69	62	42	35	37
4	1820	45	66	63	55	55	50	44	68	60	57	55	53	50	42	40	61	54	60	60	54	54	49	43	64	58	70	63	43	36	38
5	1911	50	66	64	56	56	52	46	69	61	57	56	54	50	43	40	61	55	60	61	55	55	51	45	65	59	71	64	44	37	39
6	1973	53	67	65	57	57	53	47	70	62	58	56	54	51	44	41	62	55	61	62	56	56	52	46	66	59	72	65	45	39	40

Sound power levels according to Eurovent specification 8/2 (ISO 3741/88) and Eurovent Certification
 Sound pressure calculated from sound power levels with an hypothetical room acoustic attenuation of 20dB (A)

Sound Levels

**Sound levels, 2-pipe standard capacity coil, 0Pa
Unit with rectangular flange at the discharge side and EU3 filter, no inlet air connection**

Unit size	Speed	Voltage	Airflow	ESP	Sound power levels						Sound pressure levels				
					125Hz	250Hz	500Hz	1kHz	2kHz	4kHz	Global Lin	Global Lw	Global Lp	NC level	NR level
		V	m3/h	Pa	dB	dB	dB	dB	dB	dB	dB	dB(A)	dB(A)		
100	1	2.0	106	0	24	32	34	25	15	15	37	32	23	19	21
	2	2.6	154	0	28	36	38	31	22	19	41	37	28	23	25
	3	3.2	204	0	33	39	41	36	28	24	45	41	32	27	28
	4	3.8	257	0	37	43	45	40	34	29	48	45	36	30	32
	5	4.4	310	0	41	46	48	45	39	33	52	49	40	34	36
	6	5.1	370	0	45	50	52	49	44	38	56	53	44	38	40
200	1	2.3	169	0	26	35	35	29	23	19	39	35	26	20	22
	2	3	237	0	32	39	40	34	30	24	44	40	31	25	27
	3	3.7	306	0	37	43	44	39	36	30	48	45	36	30	31
	4	4.4	375	0	41	47	48	44	41	35	52	49	40	34	35
	5	5.1	441	0	46	50	52	48	46	39	56	53	44	38	40
	6	5.8	503	0	49	53	55	52	49	43	59	57	48	41	43
300	1	2.6	210	0	30	40	36	33	24	18	42	38	29	22	24
	2	3.6	325	0	38	45	44	41	35	29	49	46	37	30	32
	3	4.6	432	0	44	50	50	47	44	37	55	52	43	37	38
	4	5.6	527	0	49	54	54	53	50	44	60	57	48	42	44
	5	6.6	609	0	52	58	58	57	55	49	64	61	52	47	49
	6	7.6	677	0	55	61	60	60	58	53	66	64	55	50	52
400	1	2.5	347	0	31	40	46	35	26	21	48	44	35	32	33
	2	3.3	483	0	37	45	50	42	34	29	52	49	40	36	37
	3	4.1	635	0	42	49	53	47	42	35	56	53	44	39	40
	4	4.9	785	0	47	53	56	52	48	41	60	57	48	42	43
	5	5.7	924	0	51	56	59	56	53	46	63	61	52	46	47
	6	6.7	1069	0	55	60	61	60	58	51	66	64	55	50	52

Sound power levels according to Eurovent specification 8/2 (ISO 3741/88) and Eurovent Certification
Sound pressure calculated from sound power levels with an hypothetical room acoustic attenuation of 9dB

Sound Levels

**Sound levels, 4-pipe standard capacity coil, 0Pa
 Unit with rectangular flange at the discharge side and EU3 filter, no inlet air connection**

Unit size	Speed	Voltage	Airflow	ESP	Sound power levels						Sound pressure levels				
					125Hz	250Hz	500Hz	1kHz	2kHz	4kHz	Global Lin	Global Lw	Global Lp	NC level	NR level
		V	m3/h	Pa	dB	dB	dB	dB	dB	dB	dB	dB(A)	dB(A)		
100	1	2.0	91	0	29	36	39	32	23	20	41	38	29	24	25
	2	2.6	131	0	33	39	42	36	28	24	45	41	32	27	28
	3	3.2	177	0	35	41	44	38	31	27	47	44	35	29	31
	4	3.8	226	0	38	44	46	41	35	30	49	46	37	31	33
	5	4.4	278	0	41	46	49	45	39	34	52	50	41	34	36
	6	5.1	338	0	46	50	52	50	45	39	56	54	45	39	41
200	1	2.3	159	0	27	36	36	30	25	20	40	36	27	21	23
	2	3.0	225	0	33	40	41	35	31	25	45	41	32	26	28
	3	3.7	291	0	38	44	45	40	37	31	49	46	37	31	32
	4	4.4	355	0	42	48	49	45	42	36	53	50	41	35	36
	5	5.1	416	0	46	51	53	49	47	40	57	54	45	39	41
	6	5.8	475	0	50	54	55	53	50	44	60	58	49	42	44
300	1	2.6	205	0	30	40	36	33	24	18	42	38	29	22	24
	2	3.6	316	0	38	45	44	41	35	29	49	46	37	30	32
	3	4.6	418	0	44	50	50	48	44	38	55	53	44	37	39
	4	5.6	509	0	49	55	55	53	51	45	60	58	49	43	45
	5	6.6	592	0	53	58	58	57	55	50	64	62	53	47	49
	6	7.6	668	0	55	61	61	60	59	54	67	65	56	50	52
400	1	2.5	308	0	30	40	46	35	25	21	48	44	35	32	33
	2	3.3	437	0	37	45	50	42	35	29	52	49	40	36	37
	3	4.1	579	0	43	49	53	48	42	36	56	54	45	39	40
	4	4.9	721	0	48	53	56	53	49	41	60	58	49	42	44
	5	5.7	855	0	51	57	59	57	54	46	63	61	52	46	48
	6	6.7	997	0	55	60	61	61	58	51	67	65	56	50	52

Sound power levels according to Eurovent specification 8/2 (ISO 3741/88) and Eurovent Certification
 Sound pressure calculated from sound power levels with an hypothetical room acoustic attenuation of 9dB

Sound Levels

**Sound levels, 4-pipe standard capacity coil, 50Pa in speed 5
 Unit with return air duct connection D200mm, discharge air duct connection D200mm and EU3 filter(s)**

Unit size	Speed	Voltage	Airflow ESP	Sound power levels												Sound pressure levels																		
				Radiated						Inlet						Outlet						Unit												
				125Hz	250Hz	500Hz	1kHz	2kHz	4kHz	Global Lin	Global Lw	125Hz	250Hz	500Hz	1kHz	2kHz	4kHz	Global Lin	Global Lw	125Hz	250Hz	500Hz	1kHz	2kHz	4kHz	Global Lin	Global Lw	125Hz	250Hz	500Hz	1kHz	2kHz	4kHz	Global Lin
1	2.3	43	9	31	32	31	24	18	16	36	31	20	22	24	20	15	15	28	25	29	33	28	19	15	15	36	28	39	33	15	6	8		
2	3	57	16	36	37	35	30	23	20	42	36	25	27	29	26	20	15	33	30	35	38	33	26	21	19	41	34	44	38	18	11	13		
3	3.7	72	25	41	42	40	35	28	24	46	41	30	32	34	31	25	20	38	35	39	43	38	32	27	24	46	39	49	43	23	16	18		
4	4.4	87	36	45	46	43	39	33	28	50	45	34	36	38	35	30	24	43	40	44	47	42	37	32	28	50	44	53	48	28	20	22		
5	5.1	102	50	49	50	47	43	37	32	54	49	38	40	42	39	34	28	46	43	48	51	46	42	37	32	54	48	57	52	32	24	26		
6	5.8	117	66	53	54	50	46	40	36	58	52	42	43	45	42	37	31	49	46	51	54	49	46	41	36	57	52	61	55	35	28	29		
1	2.6	108	7	32	34	29	29	20	19	38	33	23	27	24	20	15	15	30	25	29	33	30	23	17	19	36	31	41	35	15	9	10		
2	3.6	159	14	40	41	37	38	31	27	46	41	30	33	30	27	22	18	37	32	37	40	38	33	29	27	44	40	48	44	24	18	20		
3	4.6	208	24	46	47	43	45	40	34	52	48	35	37	36	33	30	25	42	38	43	46	44	41	39	34	50	47	54	51	31	25	27		
4	5.6	255	36	51	52	47	51	46	40	57	54	40	41	40	39	35	30	47	43	47	51	49	47	46	40	56	53	60	57	37	31	33		
5	6.6	299	50	54	56	51	55	51	44	61	57	44	45	44	43	39	34	50	47	51	54	53	52	51	45	59	57	63	61	41	35	37		
6	7.6	341	65	57	58	53	57	54	48	63	60	46	48	47	46	40	36	53	50	53	57	55	55	54	48	62	60	66	63	43	38	40		
1	2.5	144	8	31	33	38	32	20	18	41	38	21	26	24	20	15	15	42	38	31	33	36	25	17	18	39	34	44	41	21	15	17		
2	3.3	197	14	39	39	42	38	29	24	46	43	33	33	33	31	27	22	43	40	46	49	46	40	32	27	43	40	48	46	26	18	20		
3	4.1	253	24	46	44	45	44	37	30	51	48	42	39	42	35	28	23	46	43	40	43	43	39	35	30	48	45	53	50	30	24	25		
4	4.9	310	35	51	48	47	48	44	35	55	51	49	43	43	39	34	29	51	45	45	47	47	45	43	36	53	50	58	54	34	28	30		
5	5.7	368	50	55	52	50	52	49	40	59	55	53	47	44	42	40	33	55	48	49	51	50	49	49	41	57	54	62	57	37	33	35		
6	6.7	440	71	60	56	52	55	54	45	63	58	56	51	47	47	45	39	58	51	54	55	53	54	54	46	61	58	66	61	41	38	40		

Sound power levels according to Eurovent specification 8/2 (ISO 3741/88) and Eurovent Certification
 Sound pressure calculated from sound power levels with an hypothetical room acoustic attenuation of 20dB (A)

Model number

Digit 1: Manufacturing Location

E - Epinal

Digit 2-3-4: Unit Type

FCD - Horizontal Ducted Fan Coil

FED - Horizontal Ducted Fan Coil with EC motor

Digit 5-6-7: Unit Size

100 - Unit size 100

101 - Unit size 101

103 - Unit size 103

200 - Unit size 200

203 - Unit size 203

204 - Unit size 204

300 - Unit size 300

304 - Unit size 304

306 - Unit size 306

400 - Unit size 400

406 - Unit size 406

408 - Unit size 408

508 - Unit size 508

512 - Unit size 512

612 - Unit size 612

616 - Unit size 616

716 - Unit size 716

724 - Unit size 724

Digit 8: Product Design Sequence

Digit 10: Unit Voltage

1 - 230V/50Hz/1Ph

Digit 11: Coil Type

A - 2-pipe cooling only, low water pressure drop

B - 2-pipe heating only, low water pressure drop

C - 2-pipe cooling / heating (changeover) only, low water pressure drop

D - 4-pipe cooling + heating, low water pressure drop

Digit 12: Coil Fin Type

X - Aluminum (Standard)

1 - Epoxy coated Aluminum

Digit 13: Coil Selection

X - Standard

A - High capacity (2-pipe and 4-pipe)

Digit 14: Fan Motor Type

X - Standard 6 speed AC motor (for FCD) / Standard EC motor (for FED)

Digit 15-16-17: Factory Wired Fan Speed Selection

1-2-3 - Speed 1-2-3

....

....

4-5-6 - Speed 4-5-6

Digit 19: Customer connection (facing the airflow)

R - Right (water & electrical)

L - Left (water & electrical)

1 - Water right & electrical left

2 - Water left & electrical right

Digit 20-21: Literature Language

FR - French

....

....

E4 - English

Digit 22: Packaging

X - Standard

Digit 23: Electric Heater Type

W - Without

1 - 500W Bare wire resistive element(s) with 2 overheat protections

2 - 750W Bare wire resistive elements(s) with 2 overheat protections

3 - 1.0kW

4 - 1.5kW

5 - 2.0kW

6 - 3.0kW

Model number

Digit 24: Electric Heater Control

X - Standard

A - Solid state relay

Digit 25: Water Valve Type

W - Without

1 - Valve connections for site installation (terminal blocks only)

2 - 2-way valve(s)

3 - 3-way / 4 port valve(s)

Digit 26: Water coil, fan motor access

X - Standard

A - From the inside of the unit

Digit 28: Fan On/off Control (without valve or electric heater)

W - Without

1 - Remote fan switch (L): 3 speed fan switch

2 - Remote, wall thermostat (M): 3 speed fan switch + 1 stage thermostat + heating/cooling selector

Digit 29: Water Valve / Electric Heater Control (Fan runs continuously)

W - Without

A - Remote, wall thermostat (N): 3 speed fan switch, 1 stage thermostat + heating/cooling selector

B - Remote, wall thermostat (P): 3 speed fan switch, 2 stage auto thermostat

C - Remote, wall thermostat (P) + pilot relay for the electric heater (centralized)

D - Remote, wall thermostat (E) + pilot relay for the electric heater (centralized)

E - Remote, wall thermostat (P) + pilot relay and changeover sensor for the electric heater (local management)

F - Remote, wall thermostat (E) + pilot relay and changeover sensor for the electric heater (local management)

Digit 31: Trane DDC Control

W - Without

A - Mounting and configuration: ZN523 or ZN525 cascade control, 230V hot wax actuator(s) and valve(s)

B - Mounting and configuration: ZN523 or ZN525 zone control, 230V hot wax actuator(s) and valve(s)

C - Mounting and configuration: ZN523 or ZN525 cascade control, 230V 3 floating point actuator(s) and valve(s)

D - Mounting and configuration: ZN523 or ZN525 zone control, 230V 3 floating point actuator(s) and valve(s)

E - Empty control panel for Zn control + 230V 3 floating point actuator(s)

F - Empty control panel for Zn control + 230V hot wax actuator(s)

Digit 32: Other DDC controls

W - Without

K - Supplier controller mounted for manufacturing (special features)

Digit 33: Rover Software Design Sequence

Digit 36: Return Air Duct Connection Type

W - Without

A - Circular duct D159mm (nb according to unit size)

B - Circular duct D159mm (nb according to unit size + 1)

C - Circular duct D199mm (nb according to unit size)

D - Circular duct D199mm (nb according to unit size + 1)

Model number

E - Oblong = Equivalent D249mm (nb according to unit size)

F - Rectangular flanges

G - Rectangular flanges for connection to Trane discharge air grilles

Digit 37: Discharge Air Duct Connection Type

A - Circular duct D159mm (nb according to unit size)

B - Circular duct D159mm (nb according to unit size + 1)

C - Circular duct D199mm (nb according to unit size)

D - Circular duct D199mm (nb according to unit size + 1)

E - Oblong = Equivalent D249mm (nb according to unit size)

F - Rectangular flanges

G - Rectangular flanges for connection to Trane discharge air grilles

Digit 38: Fresh Air Connection

W - Without

1 - Inlet, D99mm, control panel opposite side

2 - Inlet, D99mm + 30m³/h fresh air controller, control panel opposite side

3 - Inlet, D99mm + 45m³/h fresh air controller, control panel opposite side

4 - Inlet, D124mm, control panel opposite side

5 - Inlet, D124mm + 60-130m³/h fresh air controller, control panel opposite side

A - Outlet, D99mm, right hand position

B - Outlet, D99mm + 30m³/h fresh air controller, right hand position

C - Outlet, D99mm + 45m³/h fresh air controller, right hand position

D - Outlet, D99mm, right hand position

E - Outlet, D99mm + 30m³/h fresh air controller, left hand position

F - Outlet, D99mm + 45m³/h fresh air controller, left hand position

G - Outlet, D124mm, right hand position

H - Outlet, D124mm + 60-130m³/h fresh air controller, right hand position

J - Outlet, D124mm, left hand position

K - Outlet, D124mm + 60-130m³/h fresh air controller, left hand position

Digit 40: Air Filtration

W - Without

3 - Cleanable EU3

Digit 41: Condensate pump

W - Without

A - Condensate pump (10l/h)

Digit 42: Power Supply Protection

W - Without

1 - Mains power supply fuse (100% with ZN525)

Digit 44: Flexible hose pipe

W - Without

F - Flexible hose pipe

Digit 46: Customer Water Connections

X - Standard (flat faced sealing)

A - Conical (with adaptors)

Digit 48: Bushing Mount Rubber

W - Without

A - Set of 4 pieces

Digit 50: Special

W - Without

S - Special features

Notes

Notes

Notes



TRANE®

Cooling and Heating
Systems and Services



LonMark®
SPONSOR

Literature Order Number	UNT-PRC012
Date	0210
Supersedes	UNT-PRC012-E4_0608

Trane has a policy of continuous product and product data improvement and reserves the right to change design and specifications without notice. Only qualified technicians should perform the installation and servicing of equipment referred to in this publication.

www.trane.com

For more information, contact your local
sales office or e-mail us at comfort@trane.com

Trane bvba
Lenneke Marelaan 6 -1932 Sint-Stevens-Woluwe, Belgium
ON 0888.048.262 - RPR BRUSSELS