



XStream™ Water-cooled screw chillers and Water/Water Heat pumps

Refrigerant R1234ze

Model RTWF 95 G - 420 G (355 to 1420 kW)

Model RTHF 250 G - 780 G (750 to 2760 kW)

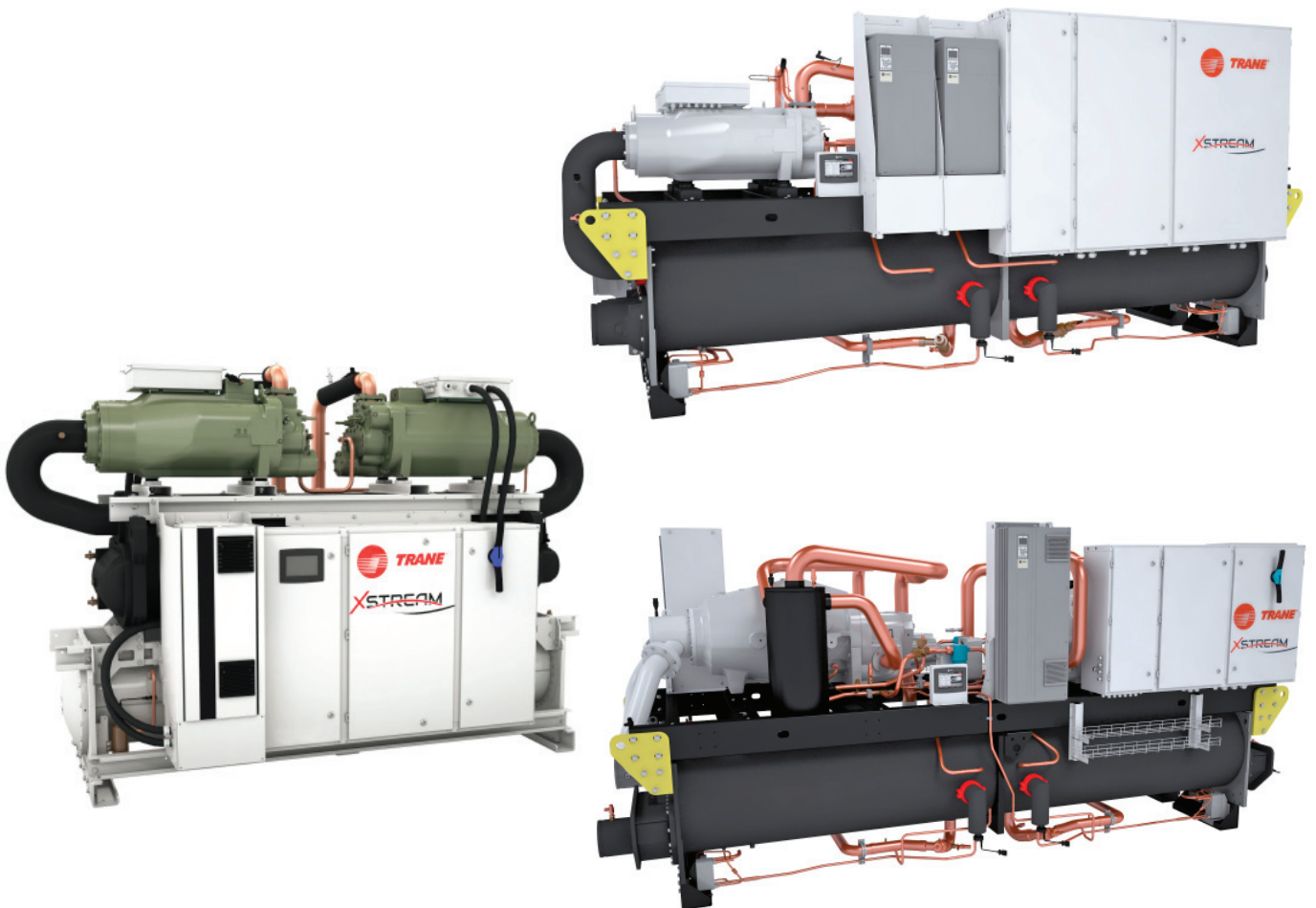

January 2021

RLC-PRC060D-GB

TRANE
TECHNOLOGIES™

Table of Contents

Introduction.....	3
Features and benefits	4
Base unit description.....	8
Options description	9
General Data	11
Heating Performance.....	21
Operating Map	22
Pressure drop.....	23
RTWF HE G / HSE G - Evaporator pressure drop.....	24
RTHF XE G - Evaporator pressure drop.....	25
RTWF 95 to 165 SE G - Condenser pressure drop	26
RTWF 220 to 360 SE G - Condenser pressure drop.....	26
RTWF 95 to 165 HE G - Condenser pressure drop.....	27
RTWF 220 to 420 HE/HSE G - Condenser pressure drop.....	27
RTHF XE G - Condenser pressure drop	28
RTHF HSE G - Condenser pressure drop.....	28
Electrical Data	29
Acoustic Data	30
Notes.....	31

Introduction

The new **Trane XStream™ RTWF G and RTHF G** series is the result of a search for higher reliability and higher energy efficiency, for today's environment.

EcoWise™

XStream™ RTWF G and RTHF G chillers with **R1234ze** low GWP refrigerants are part of the **EcoWise™** portfolio of products that are designed to lower their environmental impact with next-generation, low global warming potential (GWP) refrigerants and high-efficiency operation.

In an effort to reduce energy consumed by cooling and heating equipment and to continually operate, Trane has developed the **XStream RTWF G and RTHF G** chillers and heat pumps with higher efficiencies and a more reliable design than any other water-to-water equipment available on the market today.

The **XStream RTWF G and RTHF G** uses the proven design of the Trane helical-rotary compressors, which embraces all of the design features that have made the Trane helical-rotary compressor liquid chillers such a success since 1987.

The industrial-grade design of this helical rotary chillers and heat pumps is ideal for both industrial and commercial markets, in applications such as office buildings, hospitals, schools, retail buildings, and industrial facilities.

The major advantages of the **XStream RTWF G and RTHF G** are:

- Very low environmental impact thanks to near zero GWP (<1) R1234ze refrigerant
- High efficiencies both in cooling and heating
- 99.5% reliability rate
- Suitable with high condensing temperature and heat pump applications with possible delivery of hot water up to 85°C (RTWF G).
- Great versatility to adapt to varying applications requirements

XStream RTWF G and RTHF G come in several versions and efficiency levels, to allow customers to make the best choice according to his main criteria, whether they are economical or environmental.

Trane **XStream™ RTWF G and RTHF G** offer 4 efficiency levels:

RTWF G:

- Standard Efficiency (SE)
- High Efficiency (HE)
- High Seasonal Efficiency (HSE)

RTHF G:

- Extra High Efficiency (XE)
- High Seasonal Efficiency (HSE)

High Seasonal Efficiency (HSE) versions feature Trane Adaptive Frequency Drive (AFD) to reach High Part Load Efficiencies (ESEER).

Features and benefits

Trane Helical-Rotary Compressors

- **Unequaled-reliability.** Trane helical-rotary compressor are designed, built, and tested to the same demanding and rugged standards as the previous generation helical-rotary compressors used in both air- and water-cooled chillers for more than 27 years.
- **Years of research and testing.** The Trane helical-rotary compressors have amassed thousands of hours of testing, much of it at severe operating conditions beyond normal commercial air- conditioning applications.
- **Proven track record.** The Trane Company is the world's largest manufacturer of large helical-rotary compressors used for refrigeration. Over 400 000 compressors worldwide have proven that the Trane helical- rotary compressors have a reliability rate of greater than 99.5% in the first year of operation — unequalled in the industry.
- **Resistance to liquid slugging.** The robust design of the Trane Series R™ compressor can ingest amounts of liquid refrigerant that normally would severely damage compressor.
- **Fewer moving parts.** The helical- rotary compressor has only two rotating parts: the male rotor and the female rotor.
- **Direct-drive, low-speed,** semi- hermetic compressor for high efficiency and high reliability.
- **Field-serviceable compressor** for easy maintenance.
- **Suction-gas-cooled motor.** The motor operates at lower temperatures for longer motor life.
- **Five minute** start-to-start and two minute stop-to-start anti-recycle timer allows for closer water-loop temperature control.

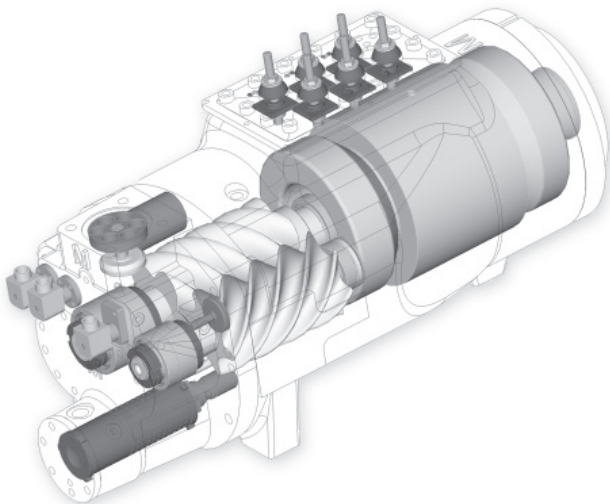

Trane GP2 compressor

Capacity Control and Load Matching

The combination patented unloading system on Trane helical- rotary compressors uses the variable unloading valve for the majority of the unloading function. This allows the compressor to modulate infinitely, to exactly match building load and to maintain chilled-water supply temperatures within $\pm 0.3^{\circ}\text{C}$ of the set point. Helical-rotary chillers that rely on stepped capacity control must run at a capacity equal to or greater than the load, and typically can only maintain water temperature to around $\pm 1^{\circ}\text{C}$. Much of this excess capacity is lost because overcooling goes toward removing building latent heat, causing the building to be dried beyond normal comfort requirements.

On **RTWF G** and **RTHF HSE G** version, the combination of the variable unloading valve plus the Adaptive Frequency™ drive allows exactly matching building load and getting excellent efficiencies at full load and part load.

HSE units (AFD equipped) are fully compliant with Class C3 (Industrial environment) requirements of EN61800-3 standard.

Features and benefits

CHIL evaporator

Trane developed an evaporator specially designed for **XStream RTWF G and RTHF G** chillers. Compact - High performance - Integrated design - Low charge (CHIL) evaporator optimizes the flow of the refrigerant to get an excellent heat exchange with water in every operating condition and minimize the quantity of refrigerant used.

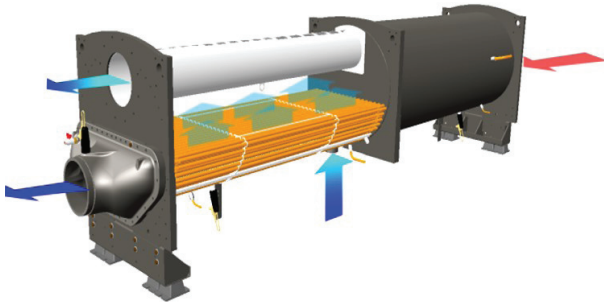

High Condensing temperatures applications

When considering heat pump or low leaving temperatures industrial process applications, compressor operates under severe pressure conditions, which, if not anticipated may be harmful for compressor or considerably decrease life and reliability of compressor. For high lift applications, **XStream RTWF G** units, feature a dedicated compressor design to keep up with those harsh operating conditions. Therefore, RTWF units can reach temperatures as low as -12°C on the evaporator side or as high as 85°C on the condensing side, yet keeping high efficiency and premier reliability.

Variable Primary Flow

An attractive chilled-water system option may be a variable primary flow (VPF) system. VPF systems present building owners with several cost-saving benefits that are directly related to the pumps. The most obvious cost savings result from eliminating the secondary distribution pump, which in turn avoids the expense incurred with the associated piping connections (material, labor), electrical service, and variable-frequency drive.

Building owners often cite pump related energy savings as the reason that prompted them to install a VPF system. With the help of a TRANE software analysis tool, you can determine whether the anticipated energy savings justify the use of variable primary flow in a particular application. It may also be easier to apply variable primary flow in an existing chilled-water plant.

Unlike the “decoupled” design, the bypass can be positioned at various points in the chilled-water loop and an additional pump is unnecessary. The evaporator in the **XStream** series can withstand up to 50% percent water flow reduction as long as this flow is equal to or above the minimum flow-rate requirements. The microprocessor and capacity control algorithms are designed to handle a maximum of 10% change in water flow rate per minute in order to maintain $\pm 0.3^\circ\text{C}$ leaving evaporator temperature control. For applications in which system energy savings is most important and tight temperature control is classified as $\pm 1.1^\circ\text{C}$, up to 30% changes in flow per minute are possible.

Factory Testing Means Trouble-Free Start-up

All **XStream** chillers are given a complete functional test at the factory. This computer-based test program completely checks the sensors, wiring, electrical components, microprocessor function, communication capability, expansion valve performance, and fans. In addition, each compressor is run-tested to verify capacity and efficiency. Where applicable, each unit is factory preset to the customer’s design conditions. An example would be the leaving-liquid temperature set point. The result of this test program is that the chiller arrives at the job site fully tested and ready for operation.

Factory-Installed and Tested Controls and Options Speed Installation

All **XStream** chiller options are factory installed and tested. Some manufacturers send accessories in pieces to be field installed. With Trane, the customer saves on installation expense and has assurance that ALL chiller controls and options have been tested and will function as expected.



Features and benefits

Superior Control with UC 800™ Chiller controls

The Adaptive Control™ microprocessor system enhances the **XStream** chiller by providing the very latest chiller control technology. With the Adaptive Control microprocessor, unnecessary service calls and unhappy tenants are avoided. The unit does not nuisance-trip or unnecessarily shut down. Only when the chiller controls have exhausted all possible corrective actions and the unit is still violating an operating limit, will the chiller shut down. Controls on other equipment typically shut down the chiller, usually just when it is needed the most.



SmartFlow control

XStream series units are fully compatible with variable flow operation both on evaporator and condenser sides. The modulation of the pump speed is managed to ensure that chiller ΔT stays constant. Entering and leaving temperatures at the evaporator will be measured directly by the chiller controller, through the factory-supplied sensor. A ΔT setpoint will be present on the unit controller. The option for constant ΔT is intended to be used with 3-way valves on water systems, or 2-way valves on water system but constant flow at the by-pass.

System option: Ice storage

UC 800 optimization software controls operation of the required equipment and accessories to easily move from one mode of operation to another. For example: even with ice-storage systems, there are numerous hours when ice is neither produced nor consumed, but saved.

In this mode, the chiller is the sole source of cooling. For example, to cool the building after all ice is produced but before high electrical demand charges take effect, UC 800 sets the chiller leaving- fluid set point to its most efficient setting and starts the chiller, chiller pump, and load pump.

When electrical demand is high, the ice pump is started and the chiller is either demand limited or shut down completely. UC 800 controls have the intelligence to optimally balance the contribution of the ice and the chiller in meeting the cooling load.

The capacity of the chiller plant is extended by operating the chiller and ice in tandem. UC 800 rations the ice, augmenting chiller capacity while reducing cooling costs. When ice is produced, UC 800 will lower the chiller leaving-fluid set point and start the chiller, ice and chiller pumps, and other accessories. Any incidental loads that persist while producing ice can be addressed by starting the load pump and drawing spent cooling fluid from the ice storage tanks.

For specific information on ice storage applications, contact your local sales office.

Features and benefits

Series counterflow chiller configuration

When considering multiple chillers plant, designers conventionally go for parallel-piped chillers configuration. Nevertheless, there are ways to bring more efficiency by using a different chiller lay-out.

An effective alternative to consider is to pipe the chillers in series. Larger ΔT and low flow design save energy on the pumping. Series chiller configuration allows as well, to get a better efficiency from the upstream chiller, more lightly loaded. Combining this configuration with Variable Primary Flow (VPF) will further increase system efficiency.

Series piping principle can also be applied to condenser side. This is called Series-Series counterflow configuration. This will result in similar advantages on the condenser side, enlarging the opportunity for savings on the overall system.

For more information on Series chillers arrangements, refer to Trane Application Engineering Manual about Multiple-Chiller system design and control (SYS-AP M001).



Product certification

Trane as a Global leader in the HVAC industry participates to both Eurovent and AHRI chillers certification programs. Through this third party certifications, Trane commits to deliver units that comply with the declared performance.



Base unit description

	RTWF 95 to 205		RTWF 220 to 420			RTHF 250 to 780	
	SE G	HE G	SE G	HE G	HSE G	XE G	HSE G
Power Supply	400 V - 3 Ph - 50 Hz - Single point						
Compressor Type	Trane CHHP/CHHW					Trane CHHC	
Compressor Technology	Fixed Speed		Fixed Speed		AFD	Fixed Speed AFD	
Number of circuits	1		2			2	
Compliance	CE - PED						
Condenser application	Cooling: Leaving Condenser Water Temp $\leq 50^{\circ}\text{C}$ Heating: Low temp Water to Water HP operation					Cooling: Leaving Condenser Water Temp $\leq 50^{\circ}\text{C}$	
Evaporator application	Cooling : Leaving Evaporator Water Temp $\geq 4.4^{\circ}\text{C}$					Cooling: Leaving Evaporator Water Temp $\geq 4.4^{\circ}\text{C}$	
Refrigerant	R1234ze						
Relief Valve	Single relief valve on condenser						
Evaporator water connections	Direct Connection - Grooved pipes						
Evaporator water side pressure	10 bar						
Condenser water connections	Direct Connection - Grooved pipes						
Condenser water side pressure	10 bar						
Flow control	Constant Flow - Pump signal On/Off (Condenser + Evaporator)						
Power protection	Fused						
Electrical IP protection	Enclosure with Dead Front protection						
Installation accessories	Optional						

Options description

Option Description	Application	Available for		
		RTWF G	RTHF G	
400 V - 3 Ph - 50 Hz - Dual point	2 distinct power supplies, one per circuit	Renovation. Replacement of two smaller units by one only.	-	•
Condenser application				
Water to water HP operation	Condenser Leaving water temperature control	Heat pump applications with Leaving water up to 85°C	•	-
2 Pass condenser	Additional pass on condenser side	Condenser application with Delta T > 7K (RTWF HE G and RTWF HSE G sizes 220 to 420 G)	•	-
Evaporator Application				
Ice making	Dual setpoint (Comfort / Ice making)	Ice storage applications for Ice making temperatures as low as -7°C	•	•
Sound Attenuation Package	Additional compressor sound enclosure	Sound reduction of 3 dB(A) per Compressor	•	-
Relief Valve				
Single relief Valve on both condenser and evaporator	Additional relief valve on Low pressure side	Additional pressure safety device	•	•
Dual Relief valve on condenser only	2 relief valve with by 3 way valve on high pressure side	Maintenance	•	•
Dual relief Valve on both evaporator and condenser	2 relief valve with by 3 way valve on both high and low side	Maintenance	•	•
Evaporator water connection				
Left hand Connection	RTWF RTWF 95 to 205 G: Location of water boxes on the left side of the unit (facing control panel) RTWF RTWF 220 to 420 G and RTHF G: Additional pipe allowing connections on the left side of the unit (facing control panel)	Supply and return water on the same side of the unit	•	•
Right hand Connection	RTWF RTWF 95 to 205 G: Location of water boxes on the right side of the unit (facing control panel) RTWF RTWF 220 to 420 G and RTHF G: Additional pipe allowing connections on the right side of the unit (facing control panel)	Supply and return water on the same side of the unit	•	•
No insulation on cold parts	Unit delivered without insulation on Evaporator and cold parts	For field supplied insulation by customer	•	•
Condenser water connection				
Left hand Connection	RTWF RTWF 95 to 205 G: Location of water boxes on the left side of the unit (facing control panel) RTWF RTWF 220 to 420 G and RTHF G: Additional pipe allowing connections on the left side of the unit (facing control panel)	Supply and return water on the same side of the unit	•	•
Right hand Connection	RTWF RTWF 95 to 205 G: Location of water boxes on the right side of the unit (facing control panel) RTWF RTWF 220 to 420 G and RTHF G: Additional pipe allowing connections on the right side of the unit (facing control panel)	Supply and return water on the same side of the unit	•	•
Condenser thermal insulation	Thermal insulation of condenser	Heat Pump application to avoid wasted heat	•	•
SmartFlow Control				
VPF Constant Delta T Evaporator	Optional PC board delivering a 2-10 V modulating signal output to control a pump motor speed inverter	Evaporator variable speed pump control based on a constant Delta T	•	•
VPF Constant Delta T Condenser	Optional PC board delivering a 2-10 V modulating signal output to control a pump motor speed inverter	Condenser variable speed pump control based on a constant Delta T	•	•
VPF Constant Delta T Evaporator and Condenser	Optional PC board delivering a 2-10 V modulating signal output to control a pump motor speed inverter	Evaporator and Condenser variable speed pump control based on constant Delta T's	•	•
Power protection	Unit protection by Circuit Breaker	Protection of compressors against over current	•	•

Options description

Option Description	Application	Available for	
		RTWF G	RTHF G
Under/over voltage protection			
Under/Over voltage protection	Phase monitoring device	Protection of unit against voltage unbalance (Standard feature on HSE variable speed units)	● ●
Under/Over voltage protection + ground fault protection	Phase monitoring device + differential circuit breaker	Protection of unit against voltage unbalance and ground fault	● ●
Smart Com protocole			
BACNet MSTP interface	Communication card	Communication with BMS through BACNet MSTP Protocol	● ●
BACNet IP interface	Communication card	Communication with BMS through BACNet IP Protocol	● ●
ModBus RTU interface	Communication card	Communication with BMS through Modbus Protocol	● ●
LonTalk Interface	Communication card	Communication with BMS through LonTalk Protocol	● ●
External setpoints & capacity outputs	Programmable Input/Output card and sensors	Remote Control or remote monitoring	▲ ▲
Outdoor Air Temp Sensor	With Outdoor Air Temp Sensor	Measurement of Outdoor ambient air temp to perform water set point offset	▲ ▲
Electrical IP Protection	IP 20 protection	Electrical safety	● ●
Master slave operation	Communication card	Operation of two chillers on a same water loop	● ●
Energy metering	Additional energy meter	Monitors electricity consumption (kWh) of the full unit	● ●
Condenser Refrigerant Pressure Output			
Condenser Water Control Output	Communication card - 0-10 V Analog output	Allows to control a valve on condenser loop to perform proper unit start when condenser water loop is cold	● ●
Condenser Pressure (%HPC) Output	Communication card - 0-10 V Analog output	Allows control of cooling device based on condenser pressure (Ice.Cooling tower fan, 3-Way valve....)	● ●
Differential Pressure Output	Communication card - 0-10 V Analog output	Allows control of a 3-way valve on condenser water loop	● ●
Power socket	230 V Power socket	Local Power source to connect an electrical device such as a Laptop	● ●
Anti vibration accessories			
Neoprene isolators		Eliminates vibration transmission risk to building	▲ ▲
Neoprene pads		Eliminates vibration transmission risk to building	▲ ▲
Grooved pipe with coupling & pipe stub	4 Grooved pipe adapters	Allows welded connection to unit	▲ ▲
Flow Switch			
Evap or Condenser Flow switch	One Flow Switch delivered to be installed either on Evaporator or Condenser side	Allows to check flow detection	▲ ▲
Evap and Condenser Flow switch	Two Flow Switches delivered to be installed respectively on Evaporator and Condenser side	Allows to check flow detection	▲ ▲

● Factory mounted ▲ Accessory (not fitted)

General Data

RTWF SE G (Standard Efficiency)

		RTWF 95 SE G	RTWF 105 SE G	RTWF 125 SE G	RTWF 135 SE G	RTWF 155 SE G	RTWF 165 SE G
Net cooling capacity (1) (2)	(kW)	358	389	471	515	555	618
Net Power Input (1) (2)	(kW)	73.4	81.0	100.0	113.9	121.7	132.6
Net EER (1) (2)		4.88	4.80	4.71	4.52	4.56	4.66
Eurovent Energy class - Cooling		B	B	B	C	C	B
SEER (3)		6.75	6.75	6.48	6.45	6.55	6.68
Space cooling efficiency $\eta_{s,c}$ (3)	(%)	267	267	256	255	259	264
Compressor							
Circuit 1		2	2	2	2	2	2
Circuit 2		-	-	-	-	-	-
Evaporator							
Pass		2					
Nominal Flow (1)	l/s	16.9	18.5	22.2	23.8	26.0	28.8
Pressure Drop (1)	kPa	48	57	66	76	84	57
Minimum Flow	l/s	8.1	8.1	8.8	8.8	8.8	12.3
Maximum Flow	l/s	35.4	35.4	38.4	38.4	38.4	53.7
Water Connection Type		Grooved end					
Water Connection Size	in	4	4	5	5	5	6
Condenser							
Pass		2					
Nominal Flow (1)	l/s	20.7	22.7	27.0	28.9	31.6	34.9
Pressure Drop (1)	kPa	59	69	67	75	62	75
Minimum Flow	l/s	8.5	8.5	10.3	10.3	12.6	12.6
Maximum Flow	l/s	31.1	31.1	37.7	37.7	46.1	46.1
Water Connection Type		Grooved end					
Water Connection Size	in	5	5	6	6	6	6
Refrigerant							
Type		R1234ze					
Charge Circuit 1	kg	84	84	77	77	106	112
Charge Circuit 2	kg	-	-	-	-	-	-
Dimensions & Weight							
Length	mm	3080	3080	3160	3160	3160	3160
Width	mm	1190	1190	1225	1225	1250	1250
Height	mm	1900	1900	1935	1935	2035	2080
Operating weight	kg	2959	2959	3128	3164	3452	3579

(1) Evaporator 12/7°C and 0.0 m²K/kW, and condenser at 30/35°C and 0.0 m²K/kW.

(2) Net performances calculated as per EN 14511-2013.

(3) $\eta_{s,c}$ / SEER as defined in Directive 2009/125/EC of the European Parliament and of the Council with regard to Ecodesign requirements for Comfort Chillers with 2000 kW maximum capacity - COMMISSION REGULATION (EU) N° 2016/2281 of 20 December 2016.

General Data

RTWF SE G (Standard Efficiency)

		RTWF 220 SE G	RTWF 240 SE G	RTWF 280 SE G	RTWF 300 SE G	RTWF 320 SE G	RTWF 360 SE G
Net cooling capacity (1) (2)	(kW)	815	867	952	1087	1169	1268
Net Power Input (1) (2)	(kW)	165.7	175.5	194.3	223.2	244.1	261.4
Net EER (1) (2)		4.92	4.94	4.90	4.87	4.79	4.85
Eurovent Energy class - Cooling		B	B	B	B	B	B
SEER (3)		6.23	6.35	6.30	7.03	6.98	7.13
Space cooling efficiency $\eta_{s,c}$ (3)	(%)	246	251	249	278	276	282
Compressor							
Circuit 1		2	2	2	2	2	2
Circuit 2		1	1	1	2	2	2
Evaporator							
Pass		1					
Nominal Flow (1)	l/s	35.1	37.6	41.8	47.5	51.7	56.6
Pressure Drop (1)	kPa	46	39	47	43	51	44
Minimum Flow	l/s	15.0	18.0	18.0	21.5	21.5	25.2
Maximum Flow	l/s	55.5	65.9	65.9	78.5	78.5	93.0
Water Connection Type		Grooved end					
Water Connection Size	in	6	6	6	8	8	8
Condenser							
Pass		2					
Nominal Flow (1)	l/s	42.0	45.1	50.3	56.5	61.6	67.5
Pressure Drop (1)	kPa	38	44	47	35	41	42
Minimum Flow	l/s	17.8	17.8	19.5	24.8	24.8	27.1
Maximum Flow	l/s	65.2	65.2	71.5	91.0	91.0	99.5
Water Connection Type		Grooved end					
Water Connection Size	in	6	6	6	8	8	8
Refrigerant							
Type		R1234ze					
Charge Circuit 1	kg	125	125	125	115	115	115
Charge Circuit 2	kg	55	55	55	115	115	115
Dimensions & Weight							
Length	mm	4784	4784	4784	4784	4784	4784
Width	mm	1727	1727	1727	1823	1823	1823
Height	mm	2032	2032	2032	2135	2135	2135
Operating weight	kg	5135	5228	5373	6554	6676	6885

(1) Evaporator 12/7°C and 0.0 m²K/kW, and condenser at 30/35°C and 0.0 m²K/kW.

(2) Net performances calculated as per EN 14511-2013.

(3) $\eta_{s,c}$ / SEER as defined in Directive 2009/125/EC of the European Parliament and of the Council with regard to Ecodesign requirements for Comfort Chillers with 2000 kW maximum capacity - COMMISSION REGULATION (EU) N° 2016/2281 of 20 December 2016.

RTWF HE G (High Efficiency)

		RTWF 95 HE G	RTWF 105 HE G	RTWF 125 HE G	RTWF 135 HE G	RTWF 155 HE G	RTWF 165 HE G
Net cooling capacity (1) (2)	(kW)	369	402	485	532	580	633
Net Power Input (1) (2)	(kW)	71.2	78.2	97.2	110.6	118.9	126.9
Net EER (1) (2)		5.18	5.14	4.99	4.81	4.88	4.99
Eurovent Energy class - Cooling		A	A	B	B	B	B
SEER (3)		6.73	6.75	6.75	6.73	6.83	7.03
Space cooling efficiency $\eta_{s,c}$ (3)	(%)	263	268	259	286	285	293
Compressor							
Circuit 1		2	2	2	2	2	2
Circuit 2		-	-	-	-	-	-
Evaporator							
Pass		2					
Nominal Flow (1)	l/s	17.4	19.1	22.6	24.3	26.7	29.1
Pressure Drop (1)	kPa	24	29	36	41	37	34
Minimum Flow	l/s	11.8	11.8	12.6	12.6	14.4	16.5
Maximum Flow	l/s	51.5	51.5	55.0	55.0	62.9	72.0
Water Connection Type		Grooved end					
Water Connection Size	in	5	5	5	5	5	6
Condenser							
Pass		2					
Nominal Flow (1)	l/s	21.3	23.4	27.5	29.4	32.4	35.3
Pressure Drop (1)	kPa	35	42	48	54	48	43
Minimum Flow	l/s	11.6	11.6	12.6	12.6	15.0	17.8
Maximum Flow	l/s	42.4	42.4	46.1	46.1	54.9	65.1
Water Connection Type		Grooved end					
Water Connection Size	in	6	6	6	6	6	6
Refrigerant							
Type		R1234ze					
Charge Circuit 1	kg	88	88	92	92	126	121
Charge Circuit 2	kg	-	-	-	-	-	-
Dimensions & Weight							
Length	mm	3080	3080	3160	3160	3160	3160
Width	mm	1190	1190	1225	1225	1250	1250
Height	mm	1935	1935	1935	1935	2035	2080
Operating weight	kg	3176.1	3176.1	3271	3307	3622	3796

(1) Evaporator 12/7°C and 0.0 m²K/kW, and condenser at 30/35°C and 0.0 m²K/kW.

(2) Net performances calculated as per EN 14511-2013.

(3) $\eta_{s,c}$ / SEER as defined in Directive 2009/125/EC of the European Parliament and of the Council with regard to Ecodesign requirements for Comfort Chillers with 2000 kW maximum capacity - COMMISSION REGULATION (EU) N° 2016/2281 of 20 December 2016.

General Data

RTWF HE G (High Efficiency)

		RTWF 220 HE G	RTWF 240 HE G	RTWF 280 HE G	RTWF 300 HE G	RTWF 320 HE G	RTWF 360 HE G
Net cooling capacity (1) (2)	(kW)	823	876	963	1099	1184	1284
Net Power Input (1) (2)	(kW)	159.2	168.1	185.2	212.2	231.3	248.4
Net EER (1) (2)		5.17	5.21	5.20	5.18	5.12	5.17
Eurovent Energy class - Cooling		A	A	A	A	A	A
SEER (3)		6.65	6.78	6.55	7.23	7.20	7.40
Space cooling efficiency $\eta_{s,c}$ (3)	(%)	263	268	259	286	285	293
Compressor							
Circuit 1		2	2	2	2	2	2
Circuit 2		1	1	1	2	2	2
Evaporator							
Pass		1					
Nominal Flow (1)	l/s	35.6	38.2	42.6	48.1	52.5	57.5
Pressure Drop (1)	kPa	47	40	49	44	52	45
Minimum Flow	l/s	15.0	18.0	18.0	21.5	21.5	25.2
Maximum Flow	l/s	55.5	65.9	65.9	78.5	78.5	93.0
Water Connection Type		Grooved end					
Water Connection Size	in	6	6	6	8	8	8
Condenser							
Pass		1					
Nominal Flow (1)	l/s	42.3	45.4	50.6	56.7	62.0	67.9
Pressure Drop (1)	kPa	16	18	18	14	17	18
Minimum Flow	l/s	29.9	29.9	34.2	41.4	41.4	44.0
Maximum Flow	l/s	111.0	111.0	125.2	151.8	151.8	161.4
Water Connection Type		Grooved end					
Water Connection Size	in	6	6	6	8	8	8
Refrigerant							
Type		R1234ze					
Charge Circuit 1	kg	155	155	155	145	145	145
Charge Circuit 2	kg	70	70	70	145	145	145
Dimensions & Weight							
Length	mm	4784	4784	4784	4784	4784	4784
Width	mm	1727	1727	1727	1823	1823	1823
Height	mm	2032	2032	2032	2135	2135	2135
Operating weight	kg	5517	5610	5804	7007	7129	7353

(1) Evaporator 12/7°C and 0.0 m²K/kW, and condenser at 30/35°C and 0.0 m²K/kW.

(2) Net performances calculated as per EN 14511-2013.

(3) $\eta_{s,c}$ / SEER as defined in Directive 2009/125/EC of the European Parliament and of the Council with regard to Ecodesign requirements for Comfort Chillers with 2000 kW maximum capacity - COMMISSION REGULATION (EU) N° 2016/2281 of 20 December 2016.

RTWF HSE G (High Seasonal Efficiency)

		RTWF 095 HSE G	RTWF 105 HSE G	RTWF 125 HSE G	RTWF 135 HSE G	RTWF 155 HSE G	RTWF 165 HSE G	RTWF 185 HSE G	RTWF 205 HSE G*
Net cooling capacity (1) (2)	(kW)	369	402	482	529	580	633	690	695
Net Power Input (1) (2)	(kW)	73.1	79.0	96.6	110.0	119.8	127.9	142.3	151.1
Net EER (1) (2)		5.05	5.09	4.99	4.81	4.84	4.95	4.85	4.60
Eurovent Energy class - Cooling		A	A	B	B	B	B	B	B
SEER (3)		6.93	7.13	6.88	6.75	7.05	7.08	6.83	6.08
Space cooling efficiency $\eta_{s,c}$ (3)	(%)	274	282	272	267	279	280	270	235
Compressor									
Circuit 1		2	2	2	2	2	2	2	2
Circuit 2		-	-	-	-	-	-	-	-
Evaporator									
Pass		2							
Nominal Flow (1)	l/s	17.4	19.1	22.6	24.3	26.7	29.1	30.8	33.3
Pressure Drop (1)	kPa	24	28	36	41	37	34	30.2	35.2
Minimum Flow	l/s	11.8	11.8	12.6	12.6	14.4	16.5	18.2	18.2
Maximum Flow	l/s	41.5	51.5	55.0	55.0	62.9	72.0	79.4	79.4
Water Connection Type		Grooved end							
Water Connection Size		5	5	5	5	5	6	6	6
Condenser									
Pass		2							
Nominal Flow (1)	l/s	21.3	23.4	27.5	29.4	32.4	35.3	37.7	40.5
Pressure Drop (1)	kPa	35	42	48	54	48	43	39.1	45.0
Minimum Flow	l/s	11.6	11.6	12.6	12.6	15	17.8	20.8	20.8
Maximum Flow	l/s	42.4	42.4	46.1	46.1	54.9	65.1	76.1	76.1
Water Connection Type		Grooved end							
Water Connection Size		6	6	6	6	6	6	6	6
Refrigerant									
Type		R1234ze							
Charge Circuit 1		88	88	92	92	126	121	147	147
Charge Circuit 2		-	-	-	-	-	-	-	-
Dimensions & Weight									
Length	mm	3080	3080	3160	3160	3160	3160	3160	3160
Width	mm	1260	1260	1350	1350	1380	1380	1380	1380
Height	mm	1935	1935	1935	1935	2035	2080	2080	2080
Operating weight	kg	3276	3276	3371	3407	3722	3896	4025	4025

(1) Evaporator 12/7°C and 0.0 m²K/kW, and condenser at 30/35°C and 0.0 m²K/kW.

(2) Net performances calculated as per EN 14511-2013.

(3) $\eta_{s,c}$ / SEER as defined in Directive 2009/125/EC of the European Parliament and of the Council with regard to Ecodesign requirements for Comfort Chillers with 2000 kW maximum capacity - COMMISSION REGULATION (EU) N° 2016/2281 of 20 December 2016.

* Featuring a High Vi Compressor.

General Data

RTWF HSE G (High Seasonal Efficiency)

		RTWF 220 HSE G	RTWF 240 HSE G	RTWF 280 HSE G	RTWF 300 HSE G	RTWF 320 HSE G	RTWF 360 HSE G	RTWF 380 HSE G	RTWF 420 HSE G*
Net cooling capacity (1) (2)	(kW)	816	869	962	1092	1177	1283	1387	1435
Net Power Input (1) (2)	(kW)	157.8	166.8	187.2	210.8	229.9	250.1	283.1	297.7
Net EER (1) (2)		5.17	5.21	5.14	5.18	5.12	5.13	4.90	4.82
Eurovent Energy class - Cooling		A	A	A	A	A	A	B	B
SEER (3)		7.00	7.00	7.40	7.18	7.15	7.30	7.15	6.60
Space cooling efficiency $\eta_{s,c}$ (3)	(%)	277	277	293	284	283	289	183	261
Compressor									
Circuit 1		2	2	2	2	2	2	2	2
Circuit 2		1	1	1	2	2	2	2	2
Evaporator									
Pass		1							
Nominal Flow (1)	l/s	35.6	38.3	42.8	48.1	52.5	57.7	62	68
Pressure Drop (1)	kPa	48	40	50	44	52	45	53	51
Minimum Flow	l/s	15.0	18.0	18.0	21.5	21.5	25.2	25.2	25.2
Maximum Flow	l/s	55.5	65.9	65.9	78.5	78.5	93.0	93.0	93.0
Water Connection Type		Grooved end							
Water Connection Size	in	6	6	6	8	8	8	8	8
Condenser									
Pass		1							
Nominal Flow (1)	l/s	42.2	45.3	50.7	56.8	62.0	68.2	74.0	80.4
Pressure Drop (1)	kPa	16	18	18	14	17	18	24	23
Minimum Flow	l/s	29.9	29.9	34.2	41.4	41.4	44.0	44.0	44.0
Maximum Flow	l/s	111.0	111.0	125.2	151.8	151.8	161.4	161.4	161.4
Water Connection Type		Grooved end							
Water Connection Size	in	6	6	6	8	8	8	8	8
Refrigerant									
Type		R1234ze							
Charge Circuit 1	kg	155	155	155	145	145	145	145	145
Charge Circuit 2	kg	70	70	70	145	145	145	145	145
Dimensions & Weight									
Length	mm	4784	4784	4784	4784	4784	4784	4784	4784
Width	mm	1727	1727	1727	1823	1823	1823	1823	1823
Height	mm	2032	2032	2032	2135	2135	2135	2135	2135
Operating weight	kg	5731	5824	6018	7221	7343	7567	7567	7653

(1) Evaporator 12/7°C and 0.0 m²K/kW, and condenser at 30/35°C and 0.0 m²K/kW.

(2) Net performances calculated as per EN 14511-2013.

(3) $\eta_{s,c}$ / SEER as defined in Directive 2009/125/EC of the European Parliament and of the Council with regard to Ecodesign requirements for Comfort Chillers with 2000 kW maximum capacity - COMMISSION REGULATION (EU) N° 2016/2281 of 20 December 2016.

* Featuring a High Vi Compressor.

RTHF XE G (Extra High Efficiency)

		RTHF 250 XE G	RTHF 270 XE G	RTHF 305 XE G	RTHF 335 XE G	RTHF 370 XE G	RTHF 400 XE G
Gross Cooling Capacity (1)	(kW)	853	943	1087	1170	1313	1401
Gross Power Input (1)	(kW)	145	161	187	202	228	242
Gross EER (1)		5.87	5.85	5.82	5.80	5.77	5.79
Net cooling capacity (1) (2)	(kW)	853	943	1087	1170	1313	1400
Net Power Input (1) (2)	(kW)	147.2	163.3	189.2	204.7	231.4	246.9
Net EER (1) (2)		5.79	5.77	5.74	5.71	5.67	5.67
Eurovent Energy class - Cooling		A	A	A	A	A	A
SEER (3)		7.25	7.13	7.15	7.26	7.06	7.17
Space cooling efficiency $\eta_{s,c}$ (3)	(%)	287	282	283	287	279	284
Compressor							
Circuit 1		1	1	1	1	1	1
Circuit 2		1	1	1	1	1	1
Evaporator							
Pass		1					
Nominal Flow (1)	l/s	40.6	44.9	51.8	55.7	62.6	66.7
Pressure Drop (1)	kPa	12	15	15	18	23	26
Minimum Flow	l/s	34.6	34.6	39.4	39.4	39.4	39.4
Maximum Flow	l/s	127	127	145	145	145	145
Water Connection Type		Grooved end					
Water Connection Size	in	8	8	8	8	8	8
Condenser							
Pass		1					
Nominal Flow (1)	l/s	48.2	53.3	61.5	66.3	74.4	79.4
Pressure Drop (1)	kPa	9	8	9	11	14	16
Minimum Flow	l/s	44.1	50.3	56.7	56.7	56.7	56.7
Maximum Flow	l/s	161.6	184.2	207.7	207.7	207.7	207.7
Water Connection Type		Grooved end					
Water Connection Size	in	8	8	8	8	8	8
Refrigerant							
Type		R1234ze					
Charge Circuit 1	kg	200	200	205	205	205	205
Charge Circuit 2	kg	200	200	210	210	210	210
Dimensions & Weight							
Length	mm	4586	4586	4586	4586	4586	4586
Width	mm	1840	1840	1840	1840	1840	1840
Height	mm	2395	2395	2395	2395	2395	2395
Operating weight	kg	7508	7560	8745	8745	9679	9679

(1) Evaporator 12/7°C and 0.0 m²K/kW, and condenser at 30/35°C and 0.0 m²K/kW.

(2) Net performances calculated as per EN 14511-2013.

(3) $\eta_{s,c}$ / SEER as defined in Directive 2009/125/EC of the European Parliament and of the Council with regard to Ecodesign requirements for Comfort Chillers with 2000 kW maximum capacity - COMMISSION REGULATION (EU) N° 2016/2281 of 20 December 2016.

General Data

RTHF XE G (Extra High Efficiency) (continued)

		RTHF 445 XE G	RTHF 490 XE G	RTHF 520 XE G	RTHF 560 XE G	RTHF 595 XE G	RTHF 630 XE G
Gross Cooling Capacity (1)	(kW)	1580	1685	1883	1964	2070	2178
Gross Power Input (1)	(kW)	251	275	296	317	344	370
Gross EER (1)		6.29	6.12	6.37	6.20	6.02	5.88
Net cooling capacity (1) (2)	(kW)	1579	1685	1882	1964	2070	2178
Net Power Input (1) (2)	(kW)	254.7	279.7	300.2	321.8	350.1	377.3
Net EER (1) (2)		6.20	6.02	6.27	6.10	5.91	5.77
Eurovent Energy class - Cooling		A	A	A	A	A	A
SEER (3)		7.75	7.23	7.76	7.54	7.54	7.32
Space cooling efficiency $\eta_{s,c}$ (3)	(%)	307	286	308	298	299	293
Compressor							
Circuit 1		1	1	1	1	1	1
Circuit 2		1	1	1	1	1	1
Evaporator							
Pass		1					
Nominal Flow (1)	l/s	75.2	80.3	89.7	93.6	98.6	103.8
Pressure Drop (1)	kPa	13	14	18	19	22	24
Minimum Flow	l/s	63.8	63.8	63.8	63.8	63.8	63.8
Maximum Flow	l/s	234	234	234	234	234	234
Water Connection Type		Grooved end					
Water Connection Size	in	10	10	10	10	10	10
Condenser							
Pass		1					
Nominal Flow (1)	l/s	88.4	94.7	105.2	110.2	116.6	123.1
Pressure Drop (1)	kPa	16	11	13	15	16	18
Minimum Flow	l/s	63.1	63.1	90.9	90.9	90.9	90.9
Maximum Flow	l/s	231.4	231.4	333.2	333.2	333.2	333.2
Water Connection Type		Grooved end					
Water Connection Size	in	10	10	10	10	10	10
Refrigerant							
Type		R1234ze					
Charge Circuit 1	kg	295	295	295	295	285	285
Charge Circuit 2	kg	305	290	290	290	290	285
Dimensions & Weight							
Length	mm	5521	5521	5521	5521	5521	5521
Width	mm	2088	2088	2088	2088	2088	2088
Height	mm	2457	2457	2457	2457	2457	2457
Operating weight	kg	12881	13356	13356	13356	13456	13566

(1) Evaporator 12/7°C and 0.0 m²K/kW, and condenser at 30/35°C and 0.0 m²K/kW.

(2) Net performances calculated as per EN 14511-2013.

(3) $\eta_{s,c}$ / SEER as defined in Directive 2009/125/EC of the European Parliament and of the Council with regard to Ecodesign requirements for Comfort Chillers with 2000 kW maximum capacity - COMMISSION REGULATION (EU) N° 2016/2281 of 20 December 2016.

RTHF HSE G (High Seasonal Efficiency)

		RTHF 270 HSE G	RTHF 295 HSE G	RTHF 320 HSE G	RTHF 355 HSE G	RTHF 405 HSE G	RTHF 440 HSE G	RTHF 480 HSE G
Gross Cooling Capacity (1)	(kW)	928	1017	1105	1213	1396	1523	1658
Gross Power Input (1)	(kW)	165	188	211	245	264	284	319
Gross EER (1)		5.61	5.40	5.23	4.94	5.28	5.36	5.20
Net cooling capacity (1) (2)	(kW)	928	1016	1104	1212	1396	1523	1657
Net Power Input (1) (2)	(kW)	168	191	214	248	267	289	325
Net EER (1) (2)		5.54	5.32	5.15	4.88	5.21	5.27	5.10
Eurovent Energy class - Cooling		A	A	A	B	A	A	A
SEER (3)		7.38	7.36	7.29	7.23	7.99	8.08	7.98
Space cooling efficiency $\eta_{s,c}$ (3)	(%)	292	291	289	286	316	320	316
Compressor								
Circuit 1		1	1	1	1	1	1	1
Circuit 2		1	1	1	1	1	1	1
Evaporator								
Pass		1						
Nominal Flow (1)	l/s	44.20	48.40	52.60	57.80	66.50	72.60	79.00
Pressure Drop (1)	kPa	14	17	20	24	25	30	36
Minimum Flow	l/s	34.6	34.6	34.6	34.6	39.4	39.4	39.4
Maximum Flow	l/s	127	127	127	127	145	145	145
Water Connection Type		Grooved end						
Water Connection Size	in	8	8	8	8	8	8	8
Condenser								
Pass		1						
Nominal Flow (1)	l/s	52.6	58.0	63.4	70.2	79.9	87.0	95.2
Pressure Drop (1)	kPa	8	10	12	15	16	19	22
Minimum Flow	l/s	50.3	50.3	50.3	50.3	56.7	56.7	56.7
Maximum Flow	l/s	184.2	184.2	184.2	184.2	207.7	207.7	207.7
Water Connection Type		Grooved end						
Water Connection Size	in	8	8	8	8	8	8	8
Refrigerant								
Type		R1234ze						
Charge Circuit 1	kg	200	195	195	195	200	200	200
Charge Circuit 2	kg	200	195	195	195	210	205	205
Dimensions & Weight								
Length	mm	4586	4586	4586	4586	4586	4586	4586
Width	mm	1940	1940	1940	1940	1940	1940	1940
Height	mm	2395	2395	2395	2395	2395	2395	2395
Operating weight	kg	7730	7720	7720	7720	8960	9959	9959

(1) Evaporator 12/7°C and 0.0 m²K/kW, and condenser at 30/35°C and 0.0 m²K/kW.

(2) Net performances calculated as per EN 14511-2013.

(3) $\eta_{s,c}$ / SEER as defined in Directive 2009/125/EC of the European Parliament and of the Council with regard to Ecodesign requirements for Comfort Chillers with 2000 kW maximum capacity - COMMISSION REGULATION (EU) N° 2016/2281 of 20 December 2016.

General Data

RTHF HSE G (High Seasonal Efficiency) (continued)

		RTHF 535 HSE G	RTHF 560 HSE G	RTHF 595 HSE G	RTHF 630 HSE G	RTHF 680 HSE G	RTHF 720 HSE G	RTHF 780 HSE G
Gross Cooling Capacity (1)	(kW)	1811	1965	2110	2255	2414	2588	2759
Gross Power Input (1)	(kW)	372	316	347	379	434	487	540
Gross EER (1)		4.87	6.23	6.08	5.95	5.56	5.32	5.11
Net cooling capacity (1) (2)	(kW)	1810	1964	2109	2254	2414	2587	2758
Net Power Input (1) (2)	(kW)	379	316	348	380	431	482	535
Net EER (1) (2)		4.77	6.12	5.97	5.82	5.48	5.23	5.01
Eurovent Energy class - Cooling		B	A	A	A	A	A	A
SEER (3)		7.87	8.15	8.11	8.08	8.29	8.10	8.02
Space cooling efficiency $\eta_{s,c}$ (3)	(%)	312	323	321	320	329	321	318
Compressor								
Circuit 1		1	1	1	1	1	1	1
Circuit 2		1	1	1	1	1	1	1
Evaporator								
Pass		1						
Nominal Flow (1)	l/s	86.30	93.60	100.50	107.40	115.00	123.30	131.40
Pressure Drop (1)	kPa	42	19	22	25	29	33	38
Minimum Flow	l/s	39.4	63.8	63.8	63.8	63.8	63.8	63.8
Maximum Flow	l/s	145	234	234	234	234	234	234
Water Connection Type		Grooved end						
Water Connection Size	in	8	10	10	10	10	10	10
Condenser								
Pass		1						
Nominal Flow (1)	l/s	105.1	109.8	118.3	126.8	137.1	148.0	158.9
Pressure Drop (1)	kPa	27	14	17	19	23	27	31
Minimum Flow	l/s	56.7	90.9	90.9	90.9	90.9	90.9	90.9
Maximum Flow	l/s	207.7	333.2	333.2	333.2	333.2	333.2	333.2
Water Connection Type		Grooved end						
Water Connection Size	in	8	10	10	10	10	10	10
Refrigerant								
Type		R1234ze						
Charge Circuit 1	kg	200	295	285	285	285	285	285
Charge Circuit 2	kg	205	290	290	285	285	285	285
Dimensions & Weight								
Length	mm	4586	5521	5521	5521	5521	5521	5521
Width	mm	1940	2088	2088	2088	2088	2088	2088
Height	mm	2395	2457	2457	2457	2457	2457	2457
Operating weight	kg	9959	13676	13816	13926	13926	13926	13926

(1) Evaporator 12/7°C and 0.0 m²K/kW, and condenser at 30/35°C and 0.0 m²K/kW.

(2) Net performances calculated as per EN 14511-2013.

(3) $\eta_{s,c}$ / SEER as defined in Directive 2009/125/EC of the European Parliament and of the Council with regard to Ecodesign requirements for Comfort Chillers with 2000 kW maximum capacity - COMMISSION REGULATION (EU) N° 2016/2281 of 20 December 2016.

Heating Performance

	40/45°C Entering / Leaving Condenser		47/55°C Entering / Leaving Condenser				55/65°C Entering / Leaving Condenser	
	10/7°C Entering / Leaving Evaporator		10/7°C Entering / Leaving Evaporator				10/7°C Entering / Leaving Evaporator	
	Net Heating Cap (kW) (1)	Net COP (1)	Net Heating Cap (kW) (1)	Net COP (1)	SCOP (2)	Space Heating efficiency $\eta_{s,h}$ (%) (2)	Net Heating Cap (kW) (1)	Net COP (1)
RTWF 095 SE G	386	4.20	363	3.50	4.65	178	-	-
RTWF 105 SE G	423	4.17	397	3.49	4.75	182	-	-
RTWF 125 SE G	498	4.27	474	3.59	5.03	193	-	-
RTWF 135 SE G	532	4.27	507	3.60	5.05	194	-	-
RTWF 155 SE G	593	4.36	555	3.60	5.00	192	-	-
RTWF 165 SE G	648	4.37	612	3.73	5.18	199	-	-
RTWF 220 SE G	822	4.63	777	3.87	5.15	198	-	-
RTWF 240 SE G	881	4.63	832	3.87	5.20	200	-	-
RTWF 280 SE G	984	4.59	930	3.85	5.15	198	-	-
RTWF 300 SE G	1095	4.60	1035	3.83	5.20	200	-	-
RTWF 320 SE G	1196	4.53	1132	3.79	5.33	205	-	-
RTWF 360 SE G	1308	4.56	1237	3.81	5.18	199	-	-
RTWF 095 HE G	393	4.40	372	3.64	4.70	180	-	-
RTWF 105 HE G	432	4.39	408	3.65	4.83	185	-	-
RTWF 125 HE G	507	4.48	479	3.72	5.10	196	-	-
RTWF 135 HE G	542	4.50	514	3.74	5.13	197	-	-
RTWF 155 HE G	597	4.54	566	3.77	5.13	197	-	-
RTWF 165 HE G	655	4.60	616	3.87	5.23	201	-	-
RTWF 220 HE G	826	4.70	781	3.91	5.13	197	741	3.16
RTWF 240 HE G	884	4.74	837	3.94	5.20	200	794	3.18
RTWF 280 HE G	988	4.69	935	3.91	5.15	198	889	3.17
RTWF 300 HE G	1098	4.76	1039	3.95	5.23	201	989	3.18
RTWF 320 HE G	1201	4.70	1137	3.92	5.35	206	1084	3.17
RTWF 360 HE G	1313	4.74	1243	3.94	5.25	202	1185	3.19
RTWF 095 HSE G	392	4.37	370	3.61	4.80	184	-	-
RTWF 105 HSE G	432	4.36	408	3.61	4.90	188	-	-
RTWF 125 HSE G	507	4.44	480	3.69	5.08	195	-	-
RTWF 135 HSE G	543	4.46	514	3.71	5.10	196	-	-
RTWF 155 HSE G	600	4.48	568	3.71	5.10	196	-	-
RTWF 165 HSE G	658	4.54	731	3.7	5.10	196	-	-
RTWF 185 HSE G	717	4.48	618	3.82	5.20	200	-	-
RTWF 205 HSE G	777	4.38	674	3.77	5.10	196	-	-
RTWF 220 HSE G	823	4.68	779	3.9	5.25	202	739	3.14
RTWF 240 HSE G	882	4.74	834	3.94	5.33	205	792	3.17
RTWF 280 HSE G	989	4.65	934	3.86	5.23	201	885	3.11
RTWF 300 HSE G	1099	4.77	1040	3.96	5.40	208	989	3.18
RTWF 320 HSE G	1201	4.71	1137	3.93	5.40	208	1084	3.17
RTWF 360 HSE G	1319	4.72	1247	3.92	5.43	209	1185	3.16
RTWF 380 HSE G	1453	4.67	1363	3.85	5.33	205	1302	3.12
RTWF 420 HSE G	1562	4.55	1481	3.8	5.35	206	1415	3.08

 Shaded area requires the 2 pass condenser option.

(1) Net performances calculated as per EN 14511-2013.

(2) $\eta_{s,h}$ / SCOP as defined in Directive 2009/125/EC of the European Parliament and of the Council with regard to Ecodesign requirements for space heaters with 400 kW maximum rated capacity - COMMISSION REGULATION (EU) N° 813/2013/EU of 2 August 2013.

Operating Map

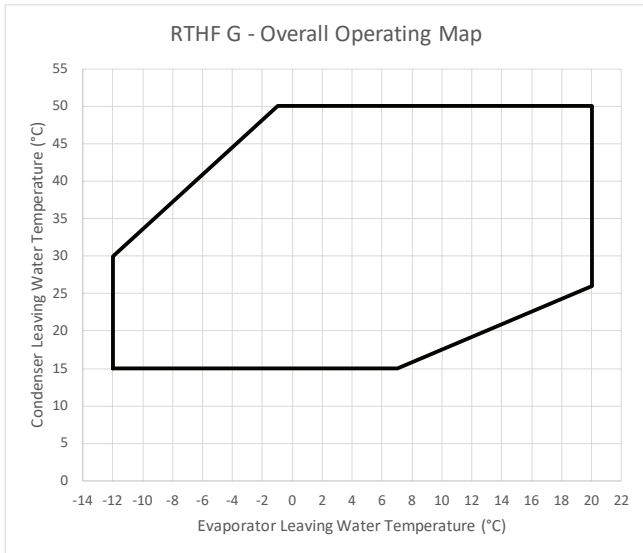
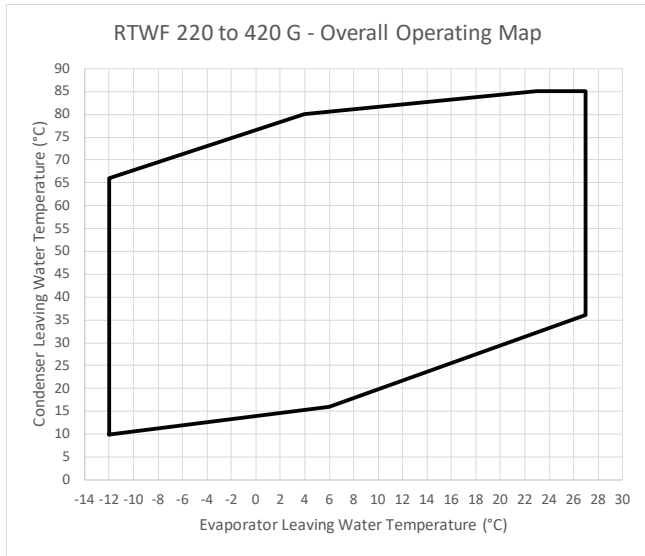
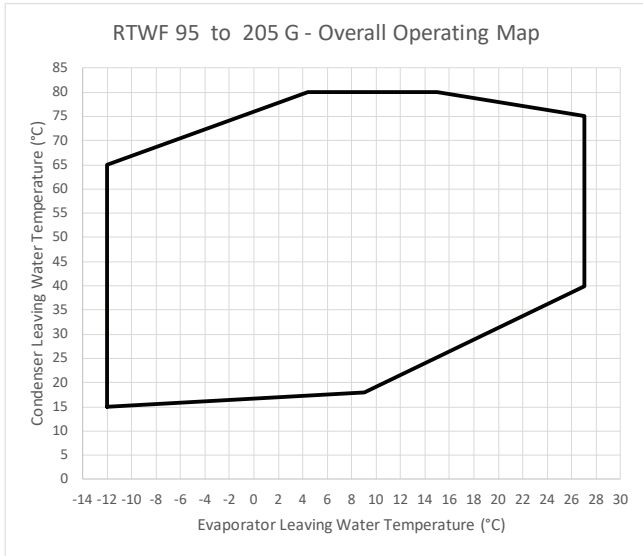

The charts above represent the overall operating limits of the unit, that is to say the limits within which unit will remain in operation. Some capacity limitations may occur depending on model and size when getting close to those limits. Always refer to Trane Official Product Selection Software output for actual operation limits of the selected unit.

Pressure drop

Evaporator pressure drop

RTWF SE G - Evaporator pressure drop

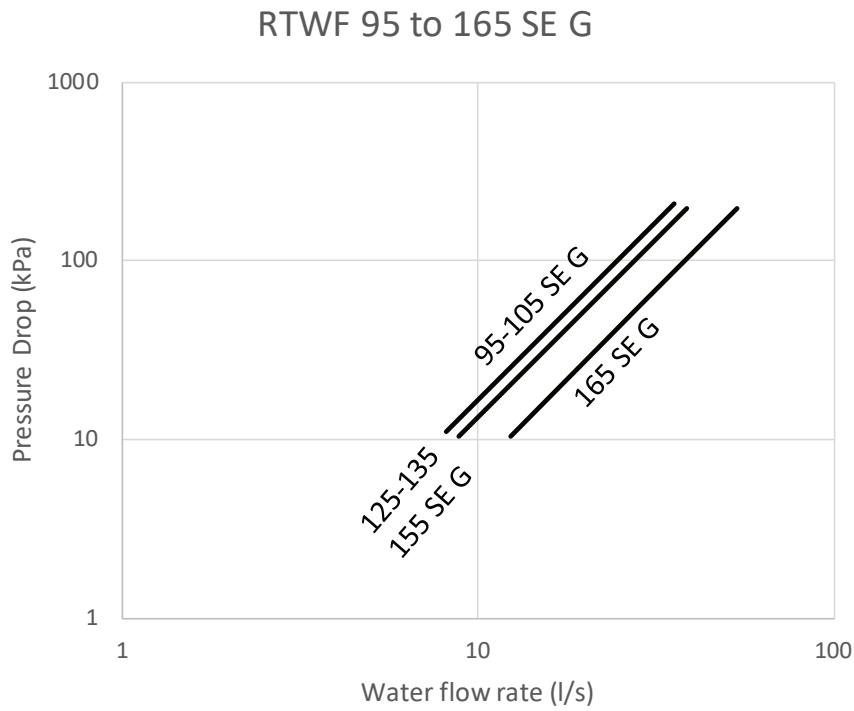

RTWF 220 to 360 SE G - Evaporator pressure drop

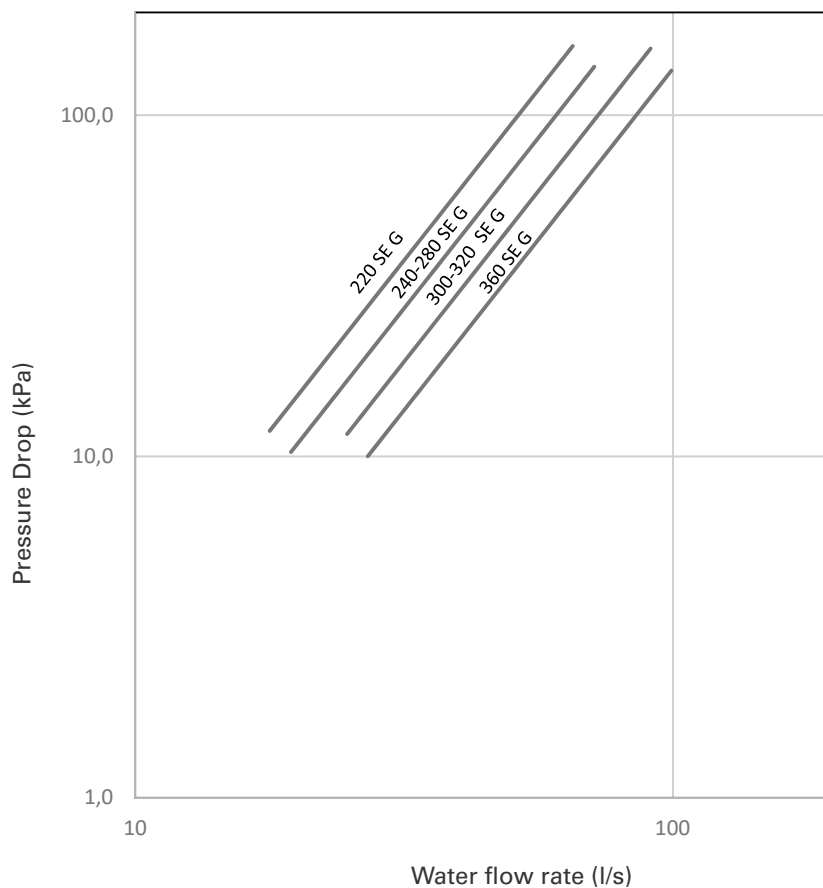

Pressure drop

RTWF HE G / HSE G - Evaporator pressure drop

RTWF 95 to 165 HE G

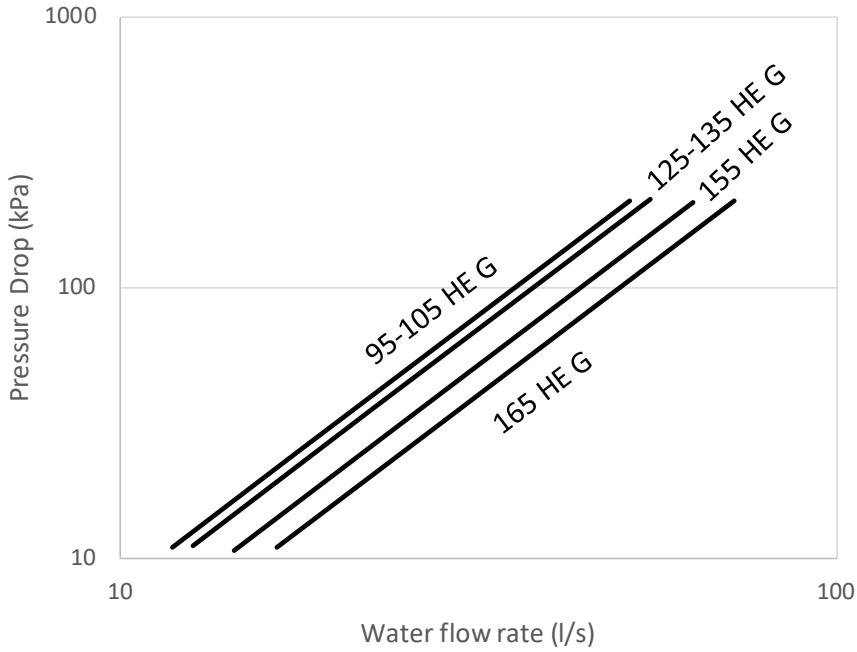

RTWF 220 to 420 HE/HSE G - Evaporator pressure drop

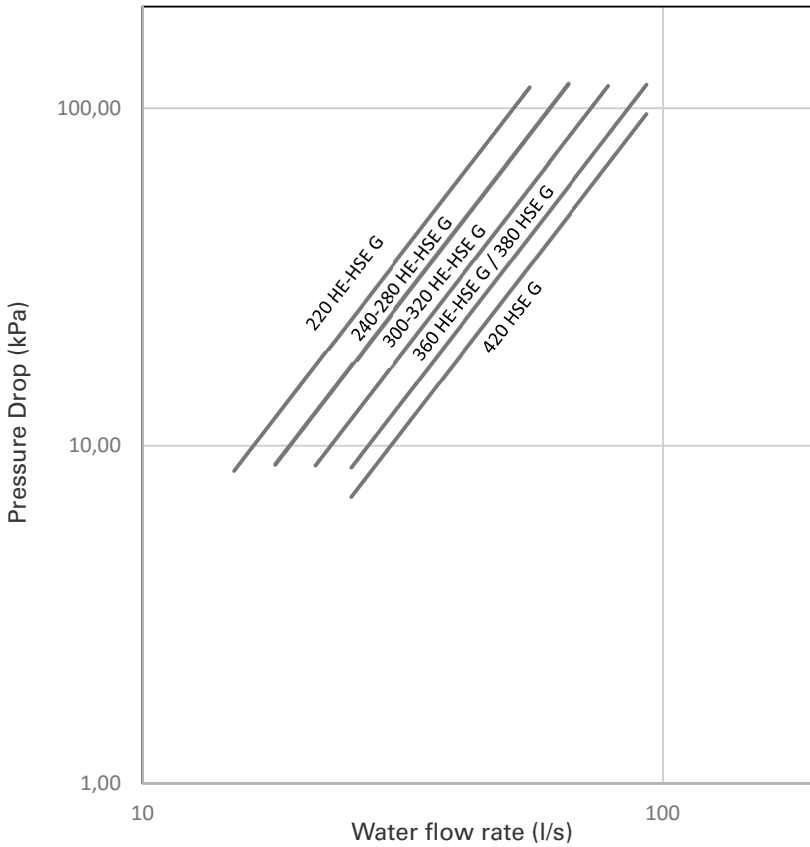

Pressure drop

RTHF XE G - Evaporator pressure drop

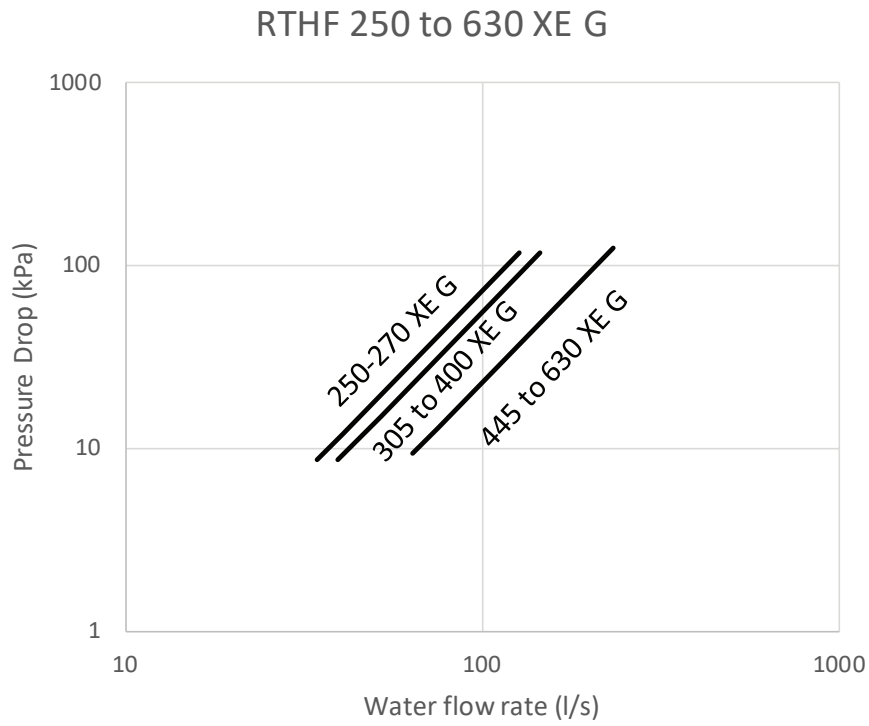

Pressure drop

RTWF 95 to 165 SE G - Condenser pressure drop

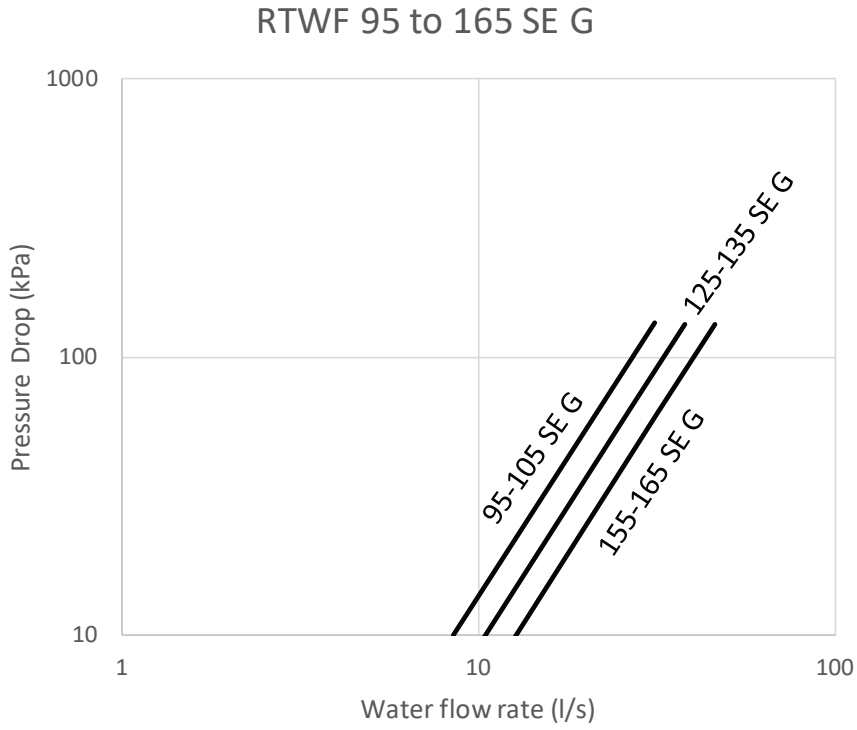

RTWF 220 to 360 SE G - Condenser pressure drop

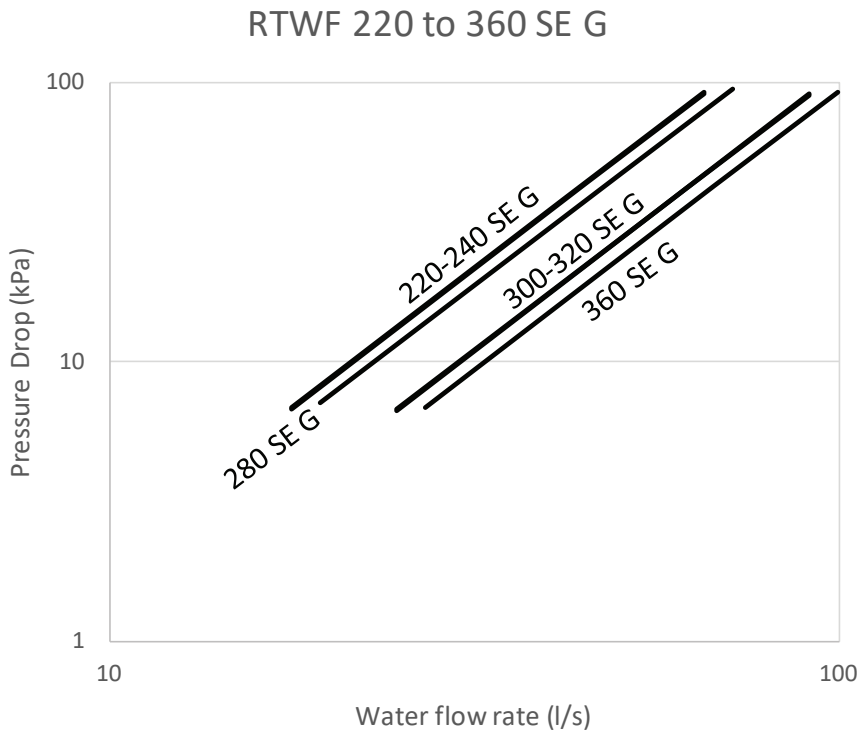

Pressure drop

RTWF 95 to 165 HE G - Condenser pressure drop

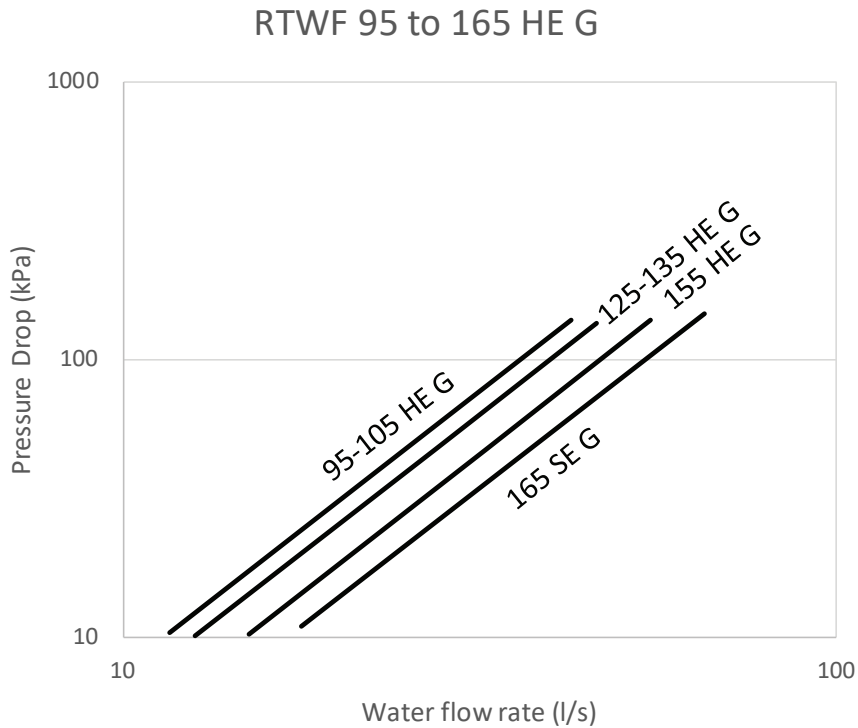

RTWF 220 to 420 HE/HSE G - Condenser pressure drop

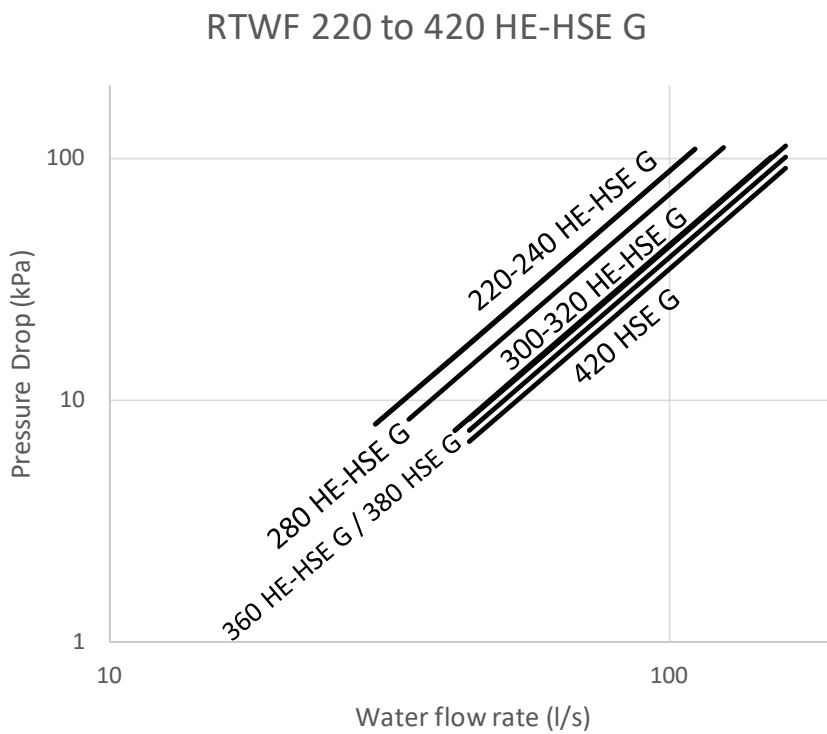

Pressure drop

RTHF XE G - Condenser pressure drop

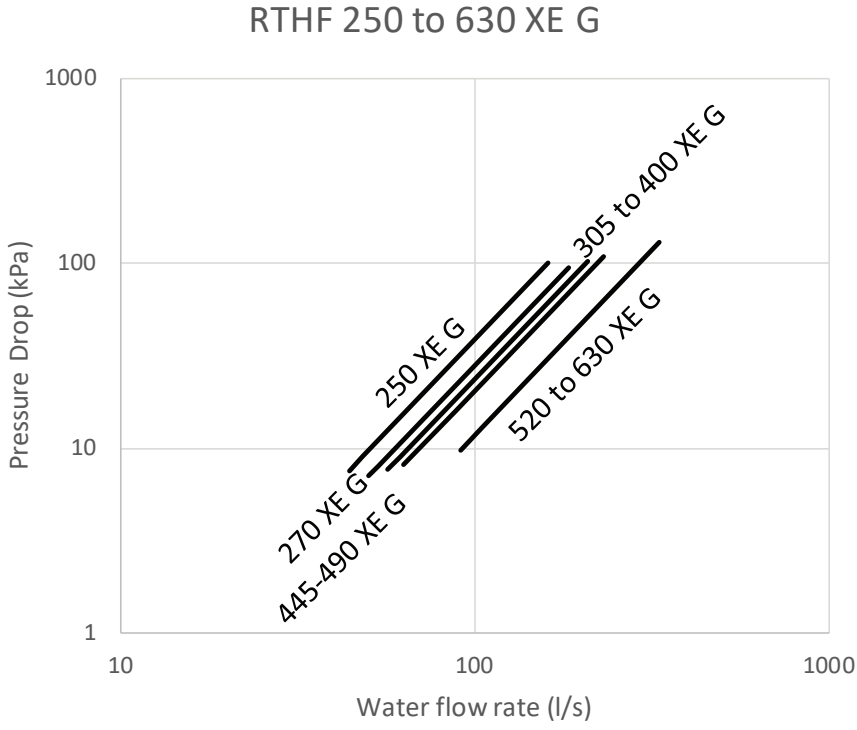

RTHF HSE G - Condenser pressure drop

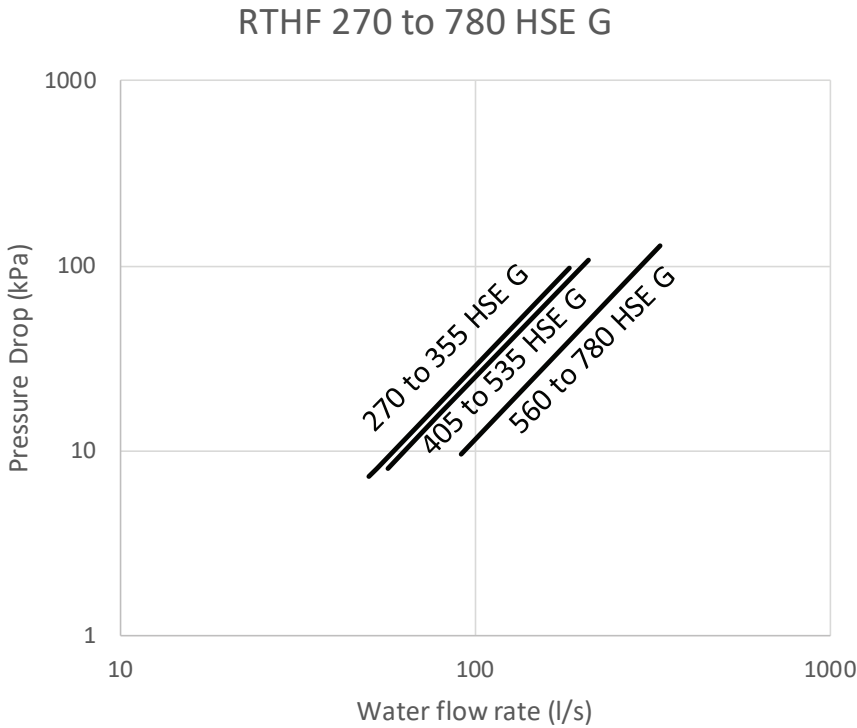

Electrical Data

RTWF SE G

		RTWF 095 SE G	RTWF 105 SE G	RTWF 125 SE G	RTWF 135 SE G	RTWF 155 SE G	RTWF 165 SE G	RTWF 220 SE G	RTWF 240 SE G	RTWF 280 SE G	RTWF 300 SE G	RTWF 320 SE G	RTWF 360 SE G
Max current	(A)	223	243	290	318	348	378	423	452	510	563	621	679
Starting current	(A)	330	350	419	451	481	544	574	637	695	714	806	864

RTWF HE G

		RTWF 095 HE G	RTWF 105 HE G	RTWF 125 HE G	RTWF 135 HE G	RTWF 155 HE G	RTWF 165 HE G	RTWF 220 HE G	RTWF 240 HE G	RTWF 280 HE G	RTWF 300 HE G	RTWF 320 HE G	RTWF 360 HE G
Max current	(A)	223	243	290	318	348	378	423	452	510	563	621	679
Starting current	(A)	330	350	419	451	481	544	574	637	695	714	806	864

RTWF HSE G

		RTWF 095 HSE G	RTWF 105 HSE G	RTWF 125 HSE G	RTWF 135 HSE G	RTWF 155 HSE G	RTWF 165 HSE G	RTWF 185 HSE G	RTWF 205 HSE G*	RTWF 220 HSE G	RTWF 240 HSE G	RTWF 280 HSE G	RTWF 300 HSE G	RTWF 320 HSE G	RTWF 360 HSE G	RTWF 380 HSE G	RTWF 420 HSE G*
Max current	(A)	214	232	281	309	334	363	406	487	405	434	488	545	603	657	718	960
Starting current	(A)	321	338	410	442	467	530	572	599	556	619	673	696	788	842	903	1074

RTHF XE G

		RTHF 250 XE G	RTHF 270 XE G	RTHF 305 XE G	RTHF 335 XE G	RTHF 370 XE G	RTHF 400 XE G	RTHF 445 XE G	RTHF 490 XE G	RTHF 520 XE G	RTHF 560 XE G	RTHF 595 XE G	RTHF 630 XE G	RTHF 680 XE G	RTHF 720 XE G	RTHF 780 XE G
Max current	(A)	466	466	582	582	698	698	804	910	910	910	910	943	976		
Starting current	(A)	645	645	761	761	829	829	1097	1203	1203	1203	1203	1236	1236		

RTHF HSE G

		RTHF 270 HSE G	RTHF 295 HSE G	RTHF 320 HSE G	RTHF 355 HSE G	RTHF 405 HSE G	RTHF 440 HSE G	RTHF 480 HSE G	RTHF 535 HSE G	RTHF 560 HSE G	RTHF 595 HSE G	RTHF 630 HSE G	RTHF 680 HSE G	RTHF 720 HSE G	RTHF 780 HSE G
Max current	(A)	394	540	540	540	647	737	754	754	827	852	877	1086	1086	1086
Starting current	(A)	394	540	540	540	647	737	754	754	827	852	877	1086	1086	1086

* With a High Vi compressor.

Acoustic Data

	Global Sound Power SWL (dB(A))	Global Sound pressure level at 10 m SPL (dB(A))
RTWF 95 SE G	96	64
RTWF 105 SE G	96	64
RTWF 125 SE G	95	63
RTWF 135 SE G	93	61
RTWF 155 SE G	93	61
RTWF 165 SE G	93	61
RTWF 220 SE G	96	64
RTWF 240 SE G	96	64
RTWF 280 SE G	96	64
RTWF 300 SE G	97	65
RTWF 320 SE G	97	65
RTWF 360 SE G	97	65
RTWF 95 HE G	96	64
RTWF 105 HE G	96	64
RTWF 125 HE G	95	63
RTWF 135 HE G	93	61
RTWF 155 HE G	93	61
RTWF 165 HE G	93	61
RTWF 220 HE G	96	64
RTWF 240 HE G	96	64
RTWF 280 HE G	96	64
RTWF 300 HE G	97	65
RTWF 320 HE G	97	65
RTWF 360 HE G	97	65
RTWF 095 HSE G	96	64
RTWF 105 HSE G	96	64
RTWF 125 HSE G	95	63
RTWF 135 HSE G	93	61
RTWF 155 HSE G	93	61
RTWF 165 HSE G	93	61
RTWF 185 HSE G	95	63
RTWF 205 HSE G	97	65
RTWF 220 HSE G	96	64
RTWF 240 HSE G	96	64
RTWF 280 HSE G	96	64
RTWF 300 HSE G	97	65
RTWF 320 HSE G	97	65
RTWF 360 HSE G	97	65
RTWF 380 HSE G	97	65
RTWF 420 HSE G	97	65
RTHF 250 XE G	97	65
RTHF 270 XE G	97	65
RTHF 305 XE G	98	66
RTHF 335 XE G	98	66
RTHF 370 XE G	98	66
RTHF 400 XE G	98	66
RTHF 445 XE G	102	70
RTHF 490 XE G	103	71
RTHF 520 XE G	103	71
RTHF 560 XE G	103	71
RTHF 595 XE G	103	71
RTHF 630 XE G	103	71
RTHF 270 HSE G	97	65
RTHF 295 HSE G	100	68
RTHF 320 HSE G	102	70
RTHF 355 HSE G	105	73
RTHF 405 HSE G	102	70
RTHF 440 HSE G	100	68
RTHF 480 HSE G	102	70
RTHF 535 HSE G	106	74
RTHF 560 HSE G	103	71
RTHF 595 HSE G	103	71
RTHF 630 HSE G	103	71
RTHF 680 HSE G	106	74
RTHF 720 HSE G	107	75
RTHF 780 HSE G	109	77



Notes

Trane - by Trane Technologies (NYSE: TT), a global climate innovator - creates comfortable, energy efficient indoor environments for commercial and residential applications. For more information, please visit trane.com or tranetechnologies.com.

Trane has a policy of continuous product and product data improvement and reserves the right to change design and specifications without notice. We are committed to using environmentally conscious print practices.

RLC-PRC060D-GB January 2021
Supersedes RLC-PRC060C-GB (March 2019)

© 2021 Trane

Confidential and proprietary Trane information