



Trane Cube

Air to water chiller and heat pumps

Rev03_01-2024

Cooling capacities:

Chiller	CGB 19 - 49.6 kW
Heat pump	CXB 15 - 78.4 kW



Summary

Product line-up

Product features: CGB, CXB

Working limits

Controllers

Main options

In a nutshell *(a single slide recap)*



Product line-up



Chiller: CGB 19 – 49.6 kW

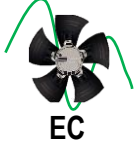

	P _c (1) kW	P _{ec} (1) kW	EER (1)	SEER (2)	η _{sc} (2) %	LwO (3) dB(A)	Refrigerant	L (4) mm	W (4) mm	H (4) mm	OW (4) kg
CGB 017	19,0	6,7	2,83	4,20	165,0	74	R410A	1807	779	1687	290
CGB 020	24,6	7,9	3,11	4,10	161,0	77	R410A	1807	779	1687	294
CGB 025	28,3	9,2	3,07	4,10	161,0	76	R410A	1807	779	1687	327
CGB 028	33,2	10,6	3,13	4,10	161,0	77	R410A	2061	779	1687	367
CGB 033	16,4	5,6	2,93	4,22	166,0	74	R410A	2061	779	1687	378
CGB 036	36,7	12,1	3,04	4,10	161,0	78	R410A	2061	779	1687	378
CGB 039	39,6	13,2	2,99	4,10	161,0	78	R410A	2061	779	1687	380
CGB 045	44,5	15,4	2,89	4,10	161,0	79	R410A	2061	779	1687	530
CGB 050	49,6	18,2	2,72	4,15	163,0	79	R410A	2061	779	1687	540

P_c: Cooling capacity

SEER: Seasonal Energy Efficiency Ratio

Refrigerant: Refrigerant type

H: Height

P_{ec}: Total power input in cooling

η_{sc}: Seasonal space cooling energy efficiency

L: Length

OW : Operating Weight

EER: Energy Efficiency Ratio (cooling)

LwO: A-weighted sound power level outside

W: Width

(1): Cooling: outdoor air temperature 35°C and chilled water temperature 12°C/7°C. (EN 14511:2022)

(2): Ecodesign rating for comfort chiller - Fan coil application. Outdoor air temperature 35°C and chilled water temperature in/ out: 12°C/7°C. η_{s,c}/SEER as defined in Ecodesign requirements for Comfort Chillers with 2000 kW maximum capacity - REGULATION (EU) N° 2016/2281 of 20 December 2016.

(3): According ISO 9614:2009. Eurovent conditions, with 1pW reference sound power (without accessories)

(4): Basic unit without accessories



Product line-up



Heat pump: CXB 15.1 – 78.4 kW



	Pc	Pec	EER	SEER	η _{sc}	Ph	Peh	COP	Ph	Peh	COP	SCOP	η _{sh}	LwO	Refrigerant	L	W	H	OW
	(1)	(1)	(1)	(2)	(2)	(3)	(3)	(3)	(4)	(4)	(4)	(5)	(5)	(6)		(7)	(7)	(7)	(4)
	kW	kW			%	kW	kW			kW	kW		%	dB(A)		mm	mm	mm	kg
CXB 017	15,1	5,8	2,60	-	-	17,4	5,4	3,23	17,8	4,4	4,06	3,73	146,0	74	R410A	1807	779	1687	328
CXB 020	17,0	6,9	2,47	-	-	20,1	6,1	3,29	20,5	4,9	4,18	3,73	146,0	74	R410A	1807	779	1687	331
CXB 025	22,0	8,4	2,62	-	-	26,5	8,0	3,32	27,2	6,6	4,15	3,70	145,0	77	R410A	1807	779	1687	365
CXB 028	25,2	9,9	2,55	-	-	31,0	9,1	3,40	31,5	7,3	4,30	3,65	143,0	76	R410A	2061	779	1687	385
CXB 033	28,5	11,9	2,39	-	-	35,7	10,5	3,40	36,6	8,7	4,20	3,78	148,0	77	R410A	2061	779	1687	396
CXB 036	31,1	14,0	2,22	-	-	39,6	12,0	3,30	40,6	9,8	4,13	3,80	149,0	78	R410A	2061	779	1687	396
CXB 039	33,3	15,5	2,15	-	-	42,5	12,9	3,30	43,8	10,8	4,04	3,78	148,0	78	R410A	2061	779	1687	398
CXB 045	40,4	16,6	2,44	-	-	48,6	15,0	3,24	50,1	12,3	4,08	3,93	154,0	79	R410A	2061	779	1687	580
CXB 050	45,0	19,7	2,29	-	-	54,4	17,0	3,20	56,0	13,9	4,02	3,80	149,0	79	R410A	2061	779	1687	590
CXB 055	50,1	17,8	2,82	-	-	57,1	17,5	3,27	59,4	14,4	4,12	3,38	132,0	81	R410A	2524	1038	1995	726
CXB 065	57,8	21,8	2,65	-	-	66,5	21,3	3,13	69,2	17,4	3,97	3,49	137,0	82	R410A	2524	1038	1995	737
CXB 080	71,2	25,1	2,84	-	-	79,0	24,9	3,17	82,3	20,7	3,98	3,24	127,0	84	R410A	2524	1038	1995	809
CXB 090	78,4	28,5	2,75	-	-	87,4	27,9	3,13	91,3	23,2	3,93	3,33	130,0	85	R410A	2524	1038	1995	815

Pc: Cooling capacity

SEER: Seasonal Energy Efficiency Ratio

Peh: Total power input in heating

η_{sh}: Seasonal space heating energy efficiency

L: Length

OW : Operating Weight

Pec: Total power input in cooling

η_{sc}: Seasonal space cooling energy efficiency

COP: Coefficient Of Performance (heating)

LwO: A-weighted sound power level outside

W: Width

EER: Energy Efficiency Ratio (cooling)

Ph: Heating capacity

SCOP: Seasonal Coefficient Of Performance

Refrigerant: Refrigerant type

H: Height

(1): Cooling: outdoor air temperature 35°C and chilled water temperature 12°C/7°C. (EN 14511:2022)

(2): Ecodesign rating for comfort chiller - Fan coil application. Outdoor air temperature 35°C and chilled water temperature in/ out: 12°C/7°C. η_{sc}/SEER as defined in Ecodesign requirements for Comfort Chillers with 2000 kW maximum capacity - REGULATION (EU) N° 2016/2281 of 20 December 2016.

(3): Outdoor air temperature 7°C - hot water temperature in/out 40/45°C. (EN 14511:2022)

(4): Outdoor air temperature 7°C - hot water temperature in/out 30/35°C. (EN 14511:2022)

(5): Ecodesign rating at low temperature conditions. Outdoor temperature: 7°C dry bulb/6°C wet bulb and hot water temperature in/out: 30°C/35°C. η_{sh} / SCOP as defined in Directive 2009/125/EC of the European Parliament and of the Council with regard to Ecodesign requirements for Space heaters and combination heaters with Prated < 400kW - COMMISSION REGULATION (EU) N° 813/2013 of 2 August 2013

(6): According ISO 9614:2009. Eurovent conditions, with 1pW reference sound power (without accessories)



Product line-up

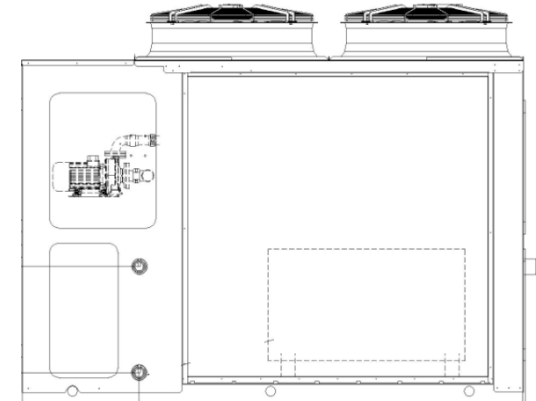
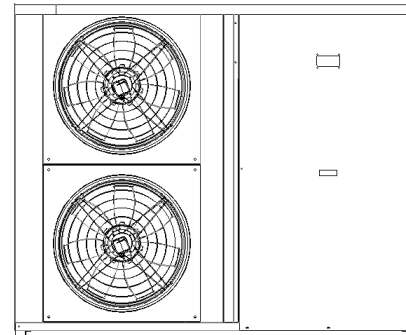
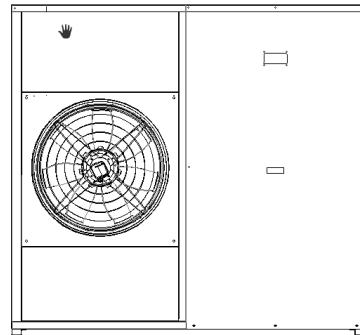

unit size	CGB	017	020	025	028	033	036	039	045	050				
	CXB	017	020	025	028	033	036	039	045	050	055	065	080	090
Length	mm	1807	1807	1807	2061	2061	2061	2061	2061	2061	2524	2524	2524	2524
Width	mm	779	779	779	779	779	779	779	779	779	1038	1038	1038	1038
Height	mm	1687	1687	1687	1687	1687	1687	1687	1687	1687	1995	1995	1995	1995

Check CAD drawings on Litweb and the selection software for deeper details

Product features

Axial fan(s)
EC type for all unit sizes

- CGB all sizes
- CXB 017 ÷ 065

AC type for CXB 080 – 090 (with 2 steps control) – EC available as an option

Thanks to EC fans, they guarantee an available external static pressure up to 80Pa, with limited performances reduction.

Condenser coil

- CXB Seamless copper tubes and aluminum fins
- CGB microchannel aluminum coil

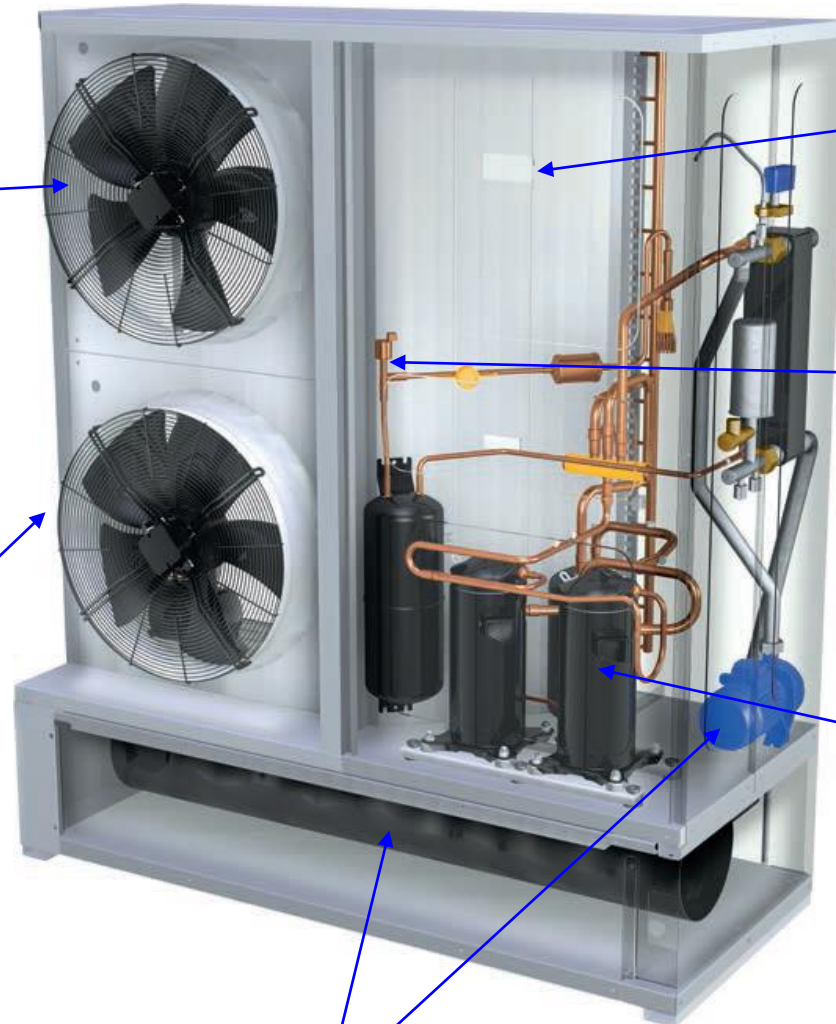

Advanced controller iPro as standard



Electronic expansion valve as standard



Tandem scroll compressors in a single circuit



Optional hydraulic circuit with pump (with inverter as an option) and water tank

Product Features: CGB / CXB

TRANE **CUBE**

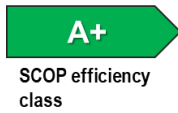

SCOP efficiency class

- ✓ Capacity steps 0 - 50% - 100%
- ✓ Temperature control on outlet water
- ✓ Brazed plate HX with differential pressure switch and antifreeze protection electric heater
- ✓ Competitive to inverter driven products from competition
- ✓ Very small refrigerant charge due to micro-channel condenser (CGB)
 - All CGB units: 5 or 6 kg of R410A
- ✓ All models only 78 cm depth up to 50 size, then 103 cm
- ✓ Electrical panel with main switch



Working limits - CGB



Standard ambient air temperature down to 5°C

- ✓ EC fan motors
- ✓ Single insulation and single electric heater on Plate Heat Exchanger

Low ambient air kit n cooling mode down to -10°C (optional) – digit 18=1

- ✓ Double insulation on Plate Heat Exchanger + additional electric heater
- ✓ Extended operating map

CGB – COOLING MODE

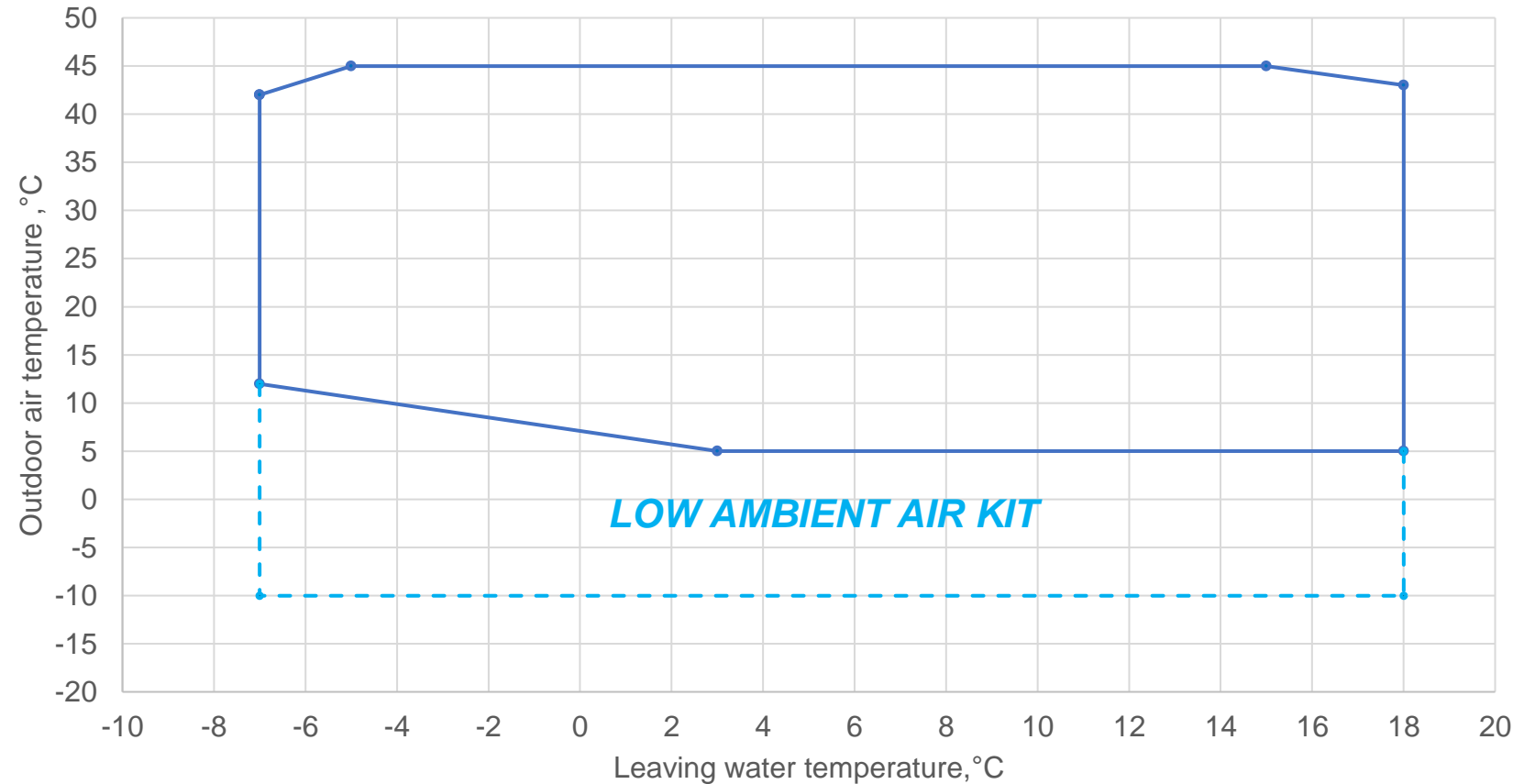

Working limits - CXB

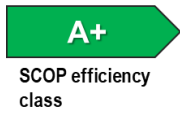

Standard ambient air temperature down to 5°C

- ✓ Dual speed fans managed by electromechanical switch (or EC fan motors according to unit size)
- ✓ Single insulation and single electric heater on Plate Heat Exchanger

Low ambient air kit down to -10°C in cooling mode (optional) – digit 18=1

- ✓ EC fan motors
- ✓ Double insulation on Plate Heat Exchanger + additional electric heater
- ✓ Extended operating map

CXB - COOLING MODE

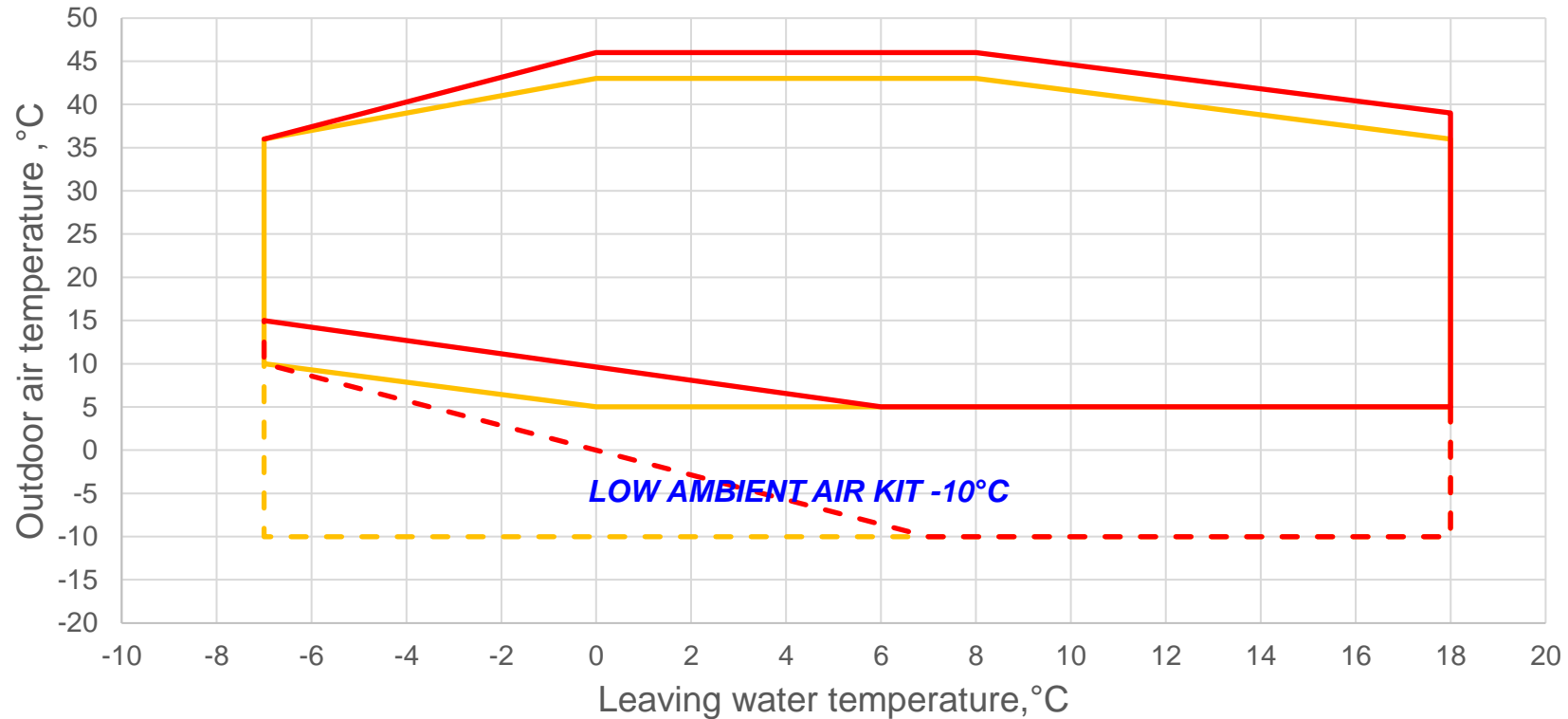

— Units 17 - 50

- - Units 17 - 50 + Low ambient temperature kit

— Units 55 - 90

- - Units 55 - 90 + Low ambient temperature kit

A certain amount of glycol may be requested according to working temperature. Check IOM for deeper details

Working limits - CXB

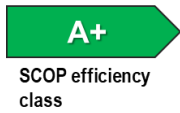

Standard ambient air temperature down to -5°C

- ✓ Dual speed fans managed by electromechanical switch (or EC fan motors according to unit size)
- ✓ Single insulation and single electric heater on Plate Heat Exchanger
- ✓ Optimized defrost management

Low ambient air kit down to -15°C (optional) – digit 30=1

- ✓ Double insulation on Plate Heat Exchanger + additional electric heater
- ✓ Digital Defrost algorithm (based on approach temperature)
- ✓ Control panel with electric heater with thermostat

CXB - HEATING MODE

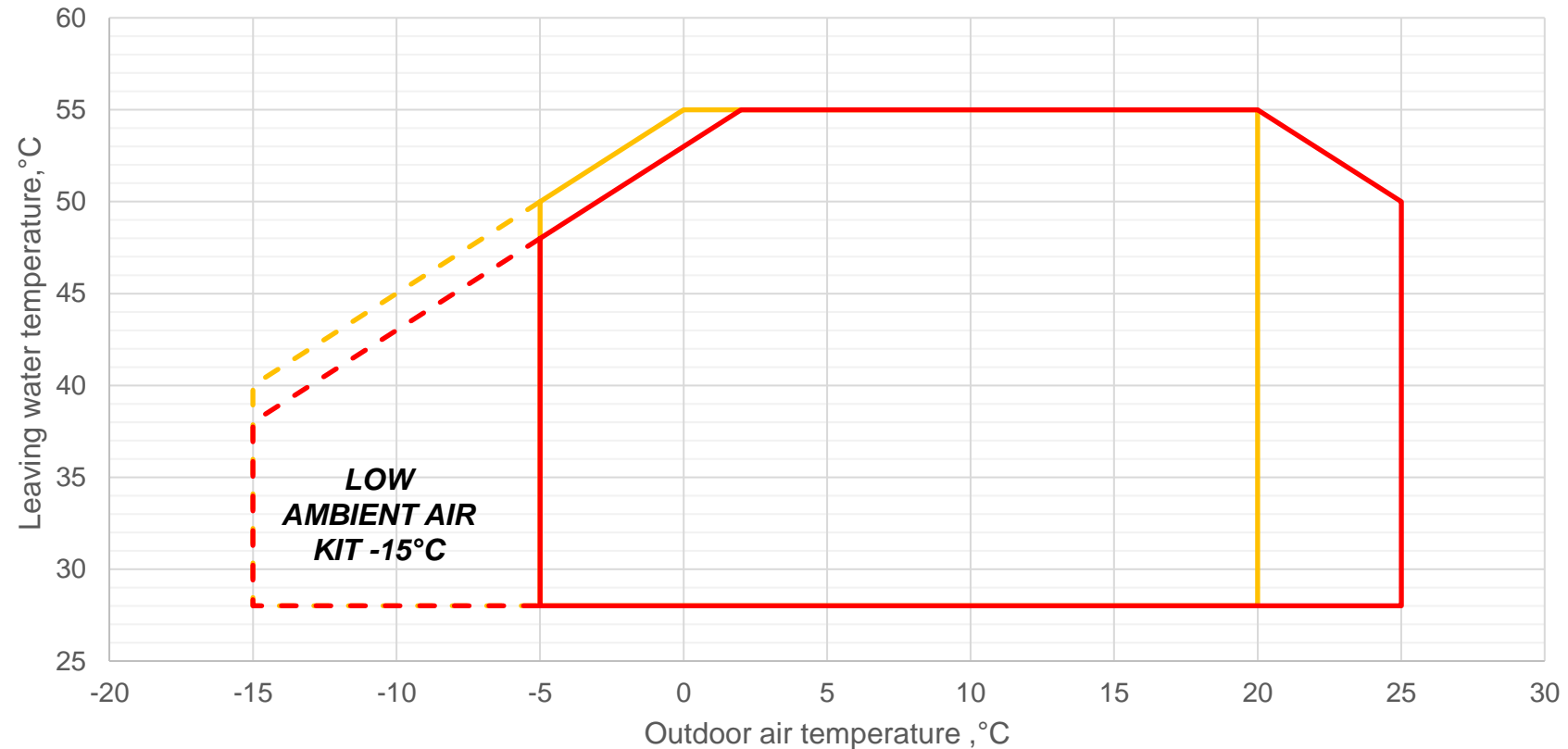

— Units 17 - 50

- - - Units 17 - 50 + Low ambient temperature kit

— Units 55 - 90

- - - Units 55-90 + Low ambient temperature kit



A certain amount of glycol may be requested according to working temperature. Check IOM for deeper details

Controllers

Advanced controller: *iPro*



- Compatibility with the main BMS systems: ModBus RS485, Bacnet TCP/IP e MS/TP, Lontalk
- Remote control by digital input
- **Energy saving**
- **DSP (Dynamic Set Point)**
- **Digital Defrost**
- Auto ON-OFF
- **Domestic hot water management** (only for CXB/ CXB HT unit)
- Compatibility with **FLEX MASTER**

Standard for CXB & CGB units



- The hydronic terminals can work with a variable water temperature according to outdoor temperature, following a climatic curve.
- It allows to adjust the outlet water temperature (SET POINT) maximizing the efficiency.

Energy saving & Auto on-off

Thanks to:

- Possibility to fix different set points according to the time of the day;
- Up to 3 time-bands;
- Optimization of energy consumption;
- Auto on-off: starts and stop according to time bands;

Digital defrost

It's a sophisticated algorithm that allows to minimize:

- time of each defrost cycle;
- number of defrost cycles.

It also prevents rapid ice formation, that leads to:

- Damages on outdoor coils;
- Suddenly low-pressure alarms.

Controllers

Auxiliary heating function (thanks to iPro advanced controller)

The controller enables an auxiliary heat source (as boiler or electric heater) to function as a replacement or support for the heat pump when the outdoor temperature drops below a certain value.

Integration

if the external temperature drops below a set limit, this source is activated as an integration for compressors, thanks to a dry contact present on the unit.



Substitution

if the external temperature drops further below a set limit, this source is activated as a replacement for compressors that will be disabled (when the efficiency of the heat pump drops drastically due to the low external temperatures).



Substitution

Integration

HP only

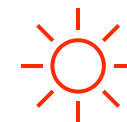

OAT, °C

Water connections



Water connections:

- Threaded for units CGB (all), CXB 017 – 050
- Victaulic for CXB 055 – 090

Check dimensional drawings on litweb for deeper details.

Main options

Domestic hot water (DHW) management (Digit 26=1)

- Thanks to **3-Ways valve kit**, it's possible to manage **domestic hot water production** with CXB /CXB HT units.
- It's therefore possible to have two different hot water set points, one for comfort, another one for DHW production
- 3-ways valve is a 230V Ac one; power feed and control is managed by the electrical cabinet of the heat pump unit
- DHW has **the priority** (as soon as the temperature inside the tank falls below the set point, the heat pump starts to produce hot water, even if it was in cooling mode); the probe to be placed in the tank is an NTC type, it's already wired to the electric cabinet of the unit
- **Anti-legionella** function is implemented into the algorithm

REMARKS:

- It's recommended **not to choose unit with integrated water tank**, to avoid energy and time wasting, since the tank is placed in series with the plate heat exchanger of the unit: better to place another one inside the hydraulic circuit if needed.
- Check the **operating limit of the heat pump in heating mode**: due to working limits it would not be possible to produce hot water in summertime!

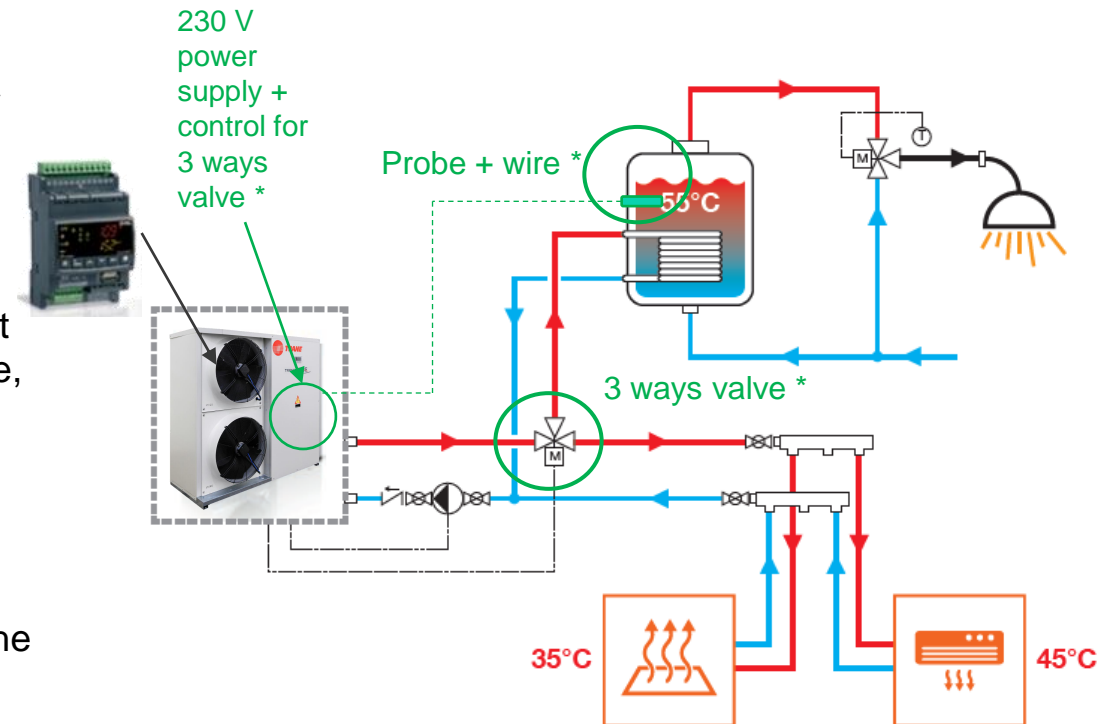

* Provided with the 3 ways valve kit

Main options

Water pump

Hydraulic kit with 1 Pump

Water pump, expansion tank, relief valve, safety valve, differential pressure switch. Water pump can be inverter driven one, with **the same features** as the non inverter one.



Flow switch



Automatic water filling



Water gauges



Water strainer
(threaded or
Victaulic one
according to unit
size)

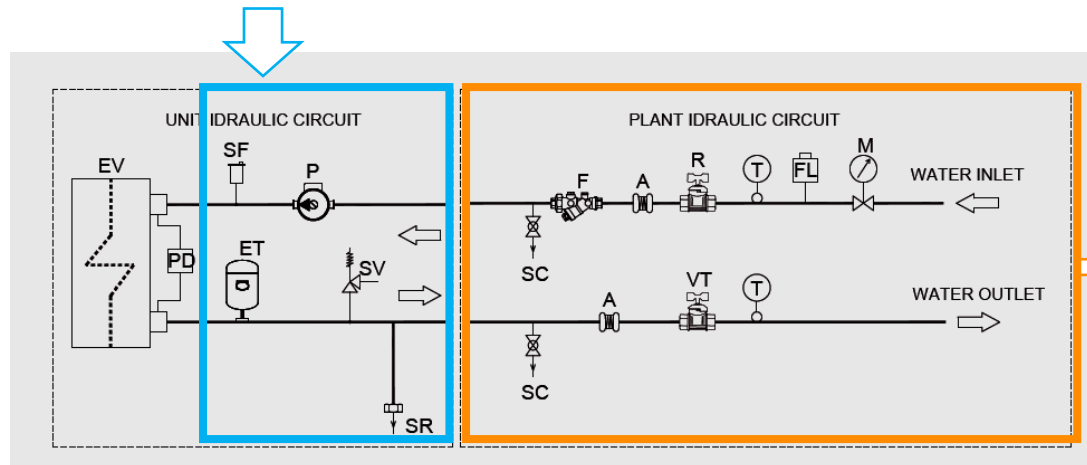

Loose options
available in
price list

M GAUGE	F WATER STRAINER	PD WATER DIFFERENTIAL PRESSURE SWITCH
FL FLOW SWITCH	SC DRAINAGE VALVE	ET EXPANSION VESSEL
T TERMOMETER	P PUMP	SV SAFETY VALVE
R SHUT OFF VALVE	SF RELIEF VALVE	SR DISCHARGE / FILLING CAP
A ANTIVIBRATION	EV EVAPORATOR	VT CALIBRATION VALVE

When glycol percentage overcomes 25%, a special sealing is needed (digit 28 =1)
For glycol concentration above 40%, please contact sales support



The installation is at customer care

Main options

Water pump + tank

Hydraulic kit with Pump + Tank

About tanks...

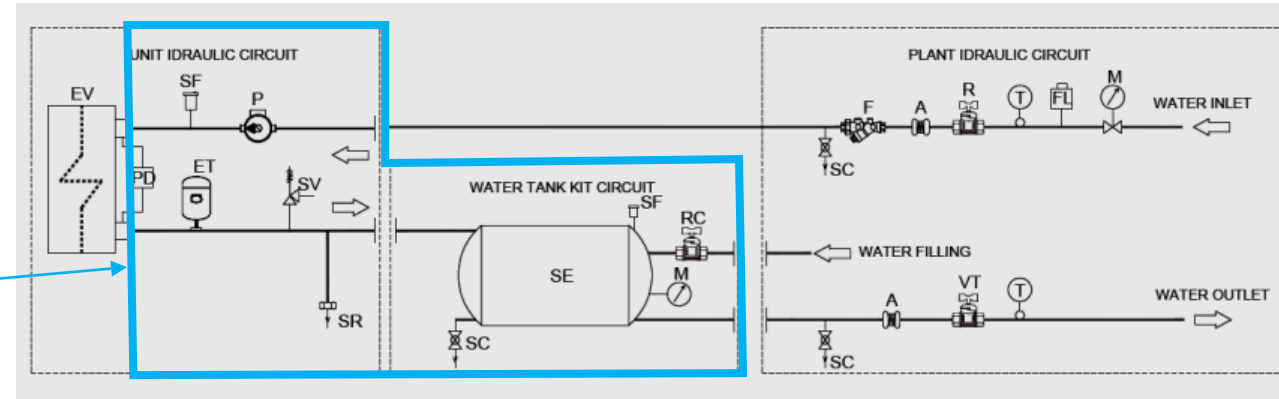

TRANE **CUBE**

CGB
CXB HT
CXB 017-050



Water tank is *provided as a loose component*, equipped with a connection kit to facilitate mounting machine-tank.

- Tank capacity 100 liters
- Installation of the water tank underneath the unit
- Installation of the tank is at customer care
- Tank insulated
- It includes drainage valve, relief valve, filling valve, pressure gauge already plug in



CXB 055-090

The water tank is *provided mounted*, is made from steel sheet.

- Tank capacity 120 liters
- Factory installed within the unit footprint
- Tank insulated
- External finishing with anti-rust treatment and painting
- It includes drainage valve, relief valve, filling valve, pressure gauge already plug in

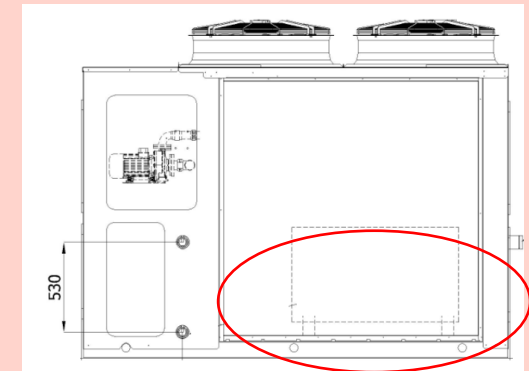

Anti freeze protection kit (opt.): all hydraulic circuit can be wrapped with additional heater elements (see IOM for deeper details) – **digit 31 =1**

Main options

LN: low noise version (Digit 8 =L – Compressor sound jacket)

Basic unit is provided with compressors jacket to reduce noise produced.
This solution led to an overall noise reduction up to **4 dB(A)**.



Low ambient air temperature (LAT) kit

..in cooling mode (digit 18) includes:

- Additional electric heater on PHE (plate heat exchanger)
- Double insulation for PHE

In heat pump mode (digit 30) includes:

- EC fans if not provided already as standard
- additional electric heater on PHE
- double insulation for PHE
- Control panel with electric heater with thermostat

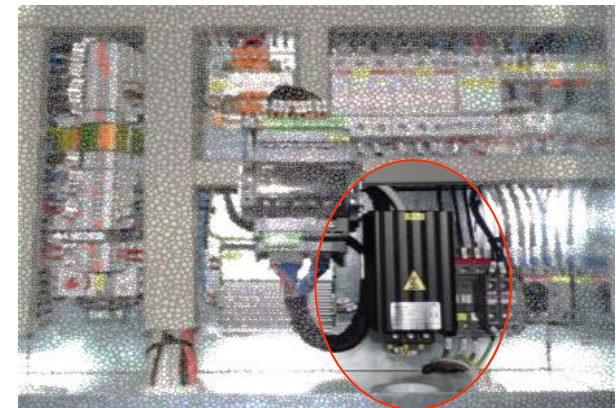

Main options

Rubber antivibration mounts

(digit 17 =1)

They reduce the dynamic stresses on the structure on which the unit is mounted
→ less vibrations, less noise

Check Litweb for details.



Victaulic kit

(digit 12=1)

Victaulic KIT includes:

- ✓ Victaulic Adapter (from Threaded to Victaulic if the unit as standard has threaded connection)
- ✓ Clamp and pipe



Main options

Soft starter

(Digit 20=1)

To reduce compressor inrush current.



Over/under voltage + phase failure protection relay

(Digit 22=1)

To protect unit from power supply instability issues



Control panel electric heater with thermostat

(Digit 21=1)

To heat the electric panel when temperature falls below an adjustable value

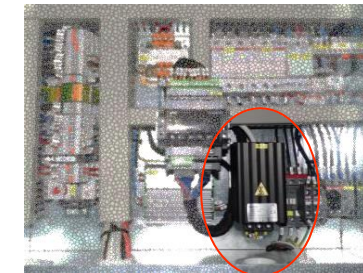

Automatic circuit breakers

Automatic circuit breaker can be reset while fuses (standard) cannot, it must be replaced, in case of intervention.



Main options

Without Neutral and with transformer (Digit 27=1)

Unit as standard has Neutral. As an option, it can be provided without.

Double isolation
network transformer

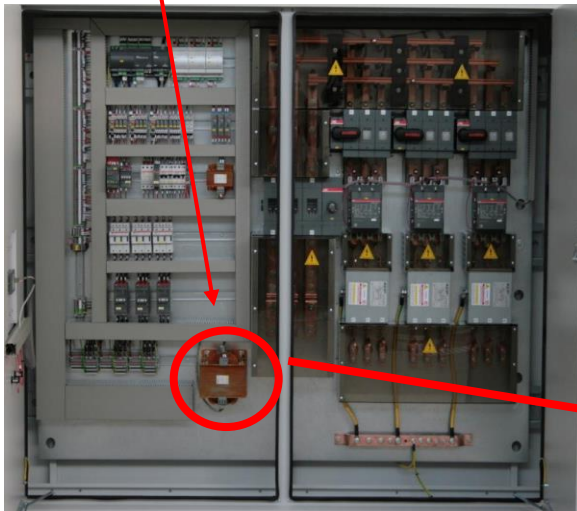

Electrical power supply standard (with NEUTRAL)

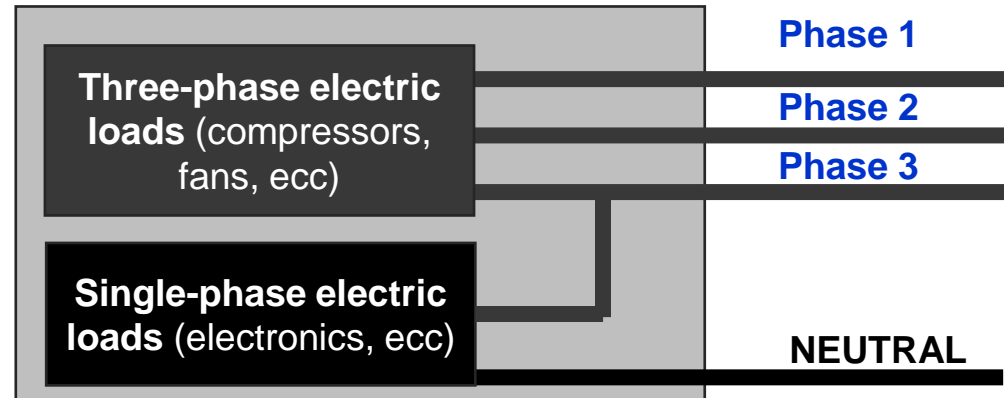

Electrical power supply with OPTIONAL (without NEUTRAL)

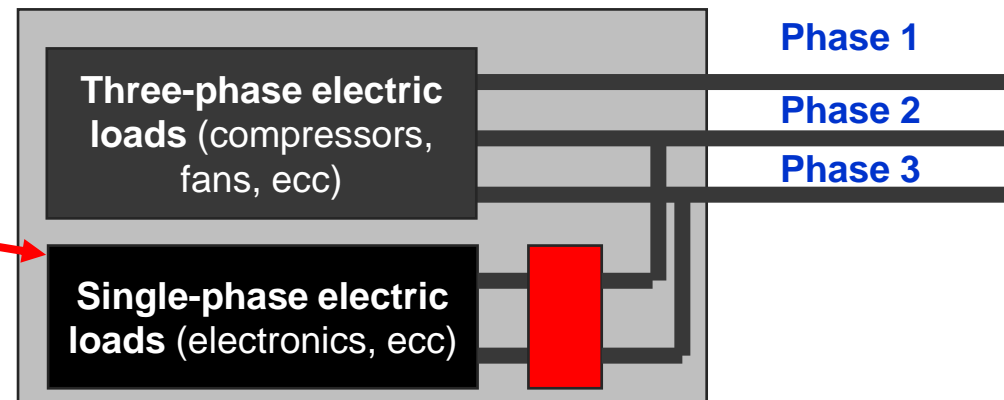

Main options

Remote control display

The unit is provided with its own display. As an option, an additional one can be provided – **Digit 10 = 2 for Ipro**



Remote Control Display for advanced controller

Remote control display for units equipped with *iPro controller*

Display menu includes:

- Probes reading
- Set point
- Alarms
- Equipment status
- Scheduling
- Domestic hot water management

Further info about the Remote control display functionalities are available in the **User guide**

Main options

FLEX Master Controller

For unit provided with advanced controller **iPro**.

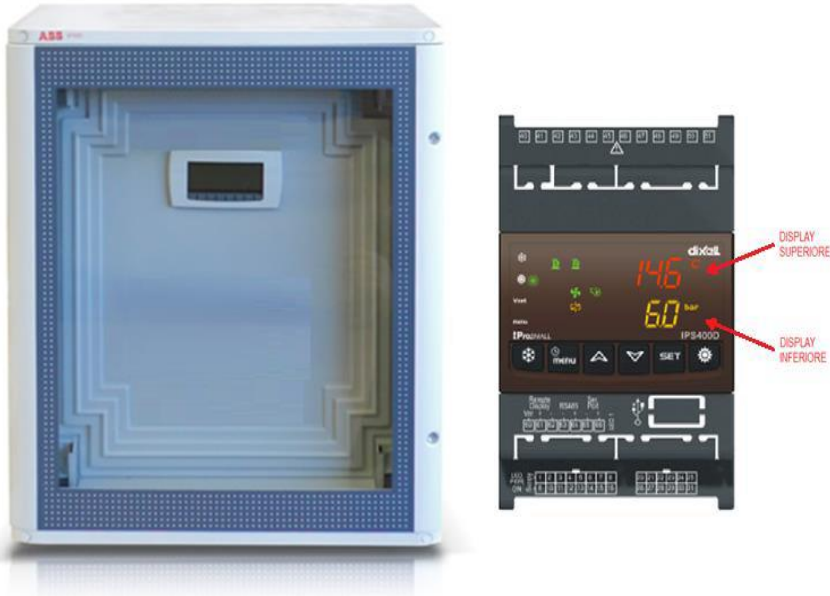

It includes Controller & User Interface



- ✓ PVC box with transparent door, UV resistant & IP Class 66
- ✓ Potential free contacts for:
 - *Activation of the system*
 - *Water pump(s) activation*
 - *Seasonal setting adjustments with external signal*
 - *Generic alarm signals*
 - *Possible alarm state of external water pump(s)*
 - *Double set point management*
- ✓ BMS connection via Modbus protocol / RS485
- ✓ Input & output probes for the main user
- ✓ External air probe
- ✓ Probes for secondary user temperature control like total or partial recovery and Domestic Hot Water (DHW) production (only if required)

Main options

FLEX Master Controller

- Different plant configuration can be managed thanks to Flex master controller, even with different type of units (all with iPro controller)
- **Flex Master** controller provides various options for activating the sequence of the capacity steps between the different units (**up to 6 units** can be controlled by a unique Flex Master)
- For deeper details, consult the documentation in the Litweb!

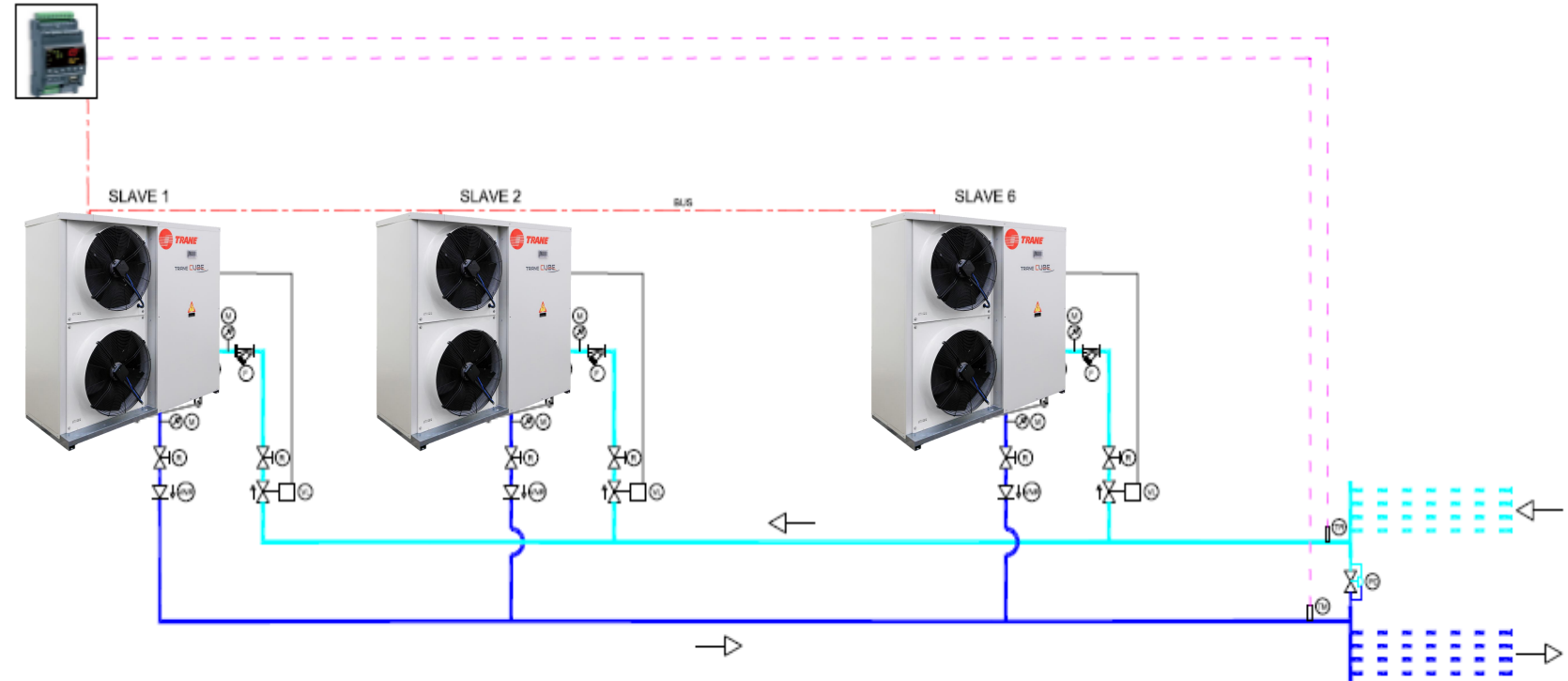





In a nutshell



RANGE

Cooling: 15 – 78 kW
Heating: 17 – 87 kW

WORKING LIMITS

Cooling		-7 ↔ 18°C		-10 ↔ 45°C
Heating		CXB: 28 ↔ 55°C		CXB: -15 ↔ 25°C

CONTROLLER



advanced controller iPro as standard.

MAIN ACCESSORIES

- Low noise version down to -4 dB
- Water pump with or without inverter and tank
- Flex master controller to manage up to 6 units
- Phase inversion, anti-freeze kits...

APPLICATIONS

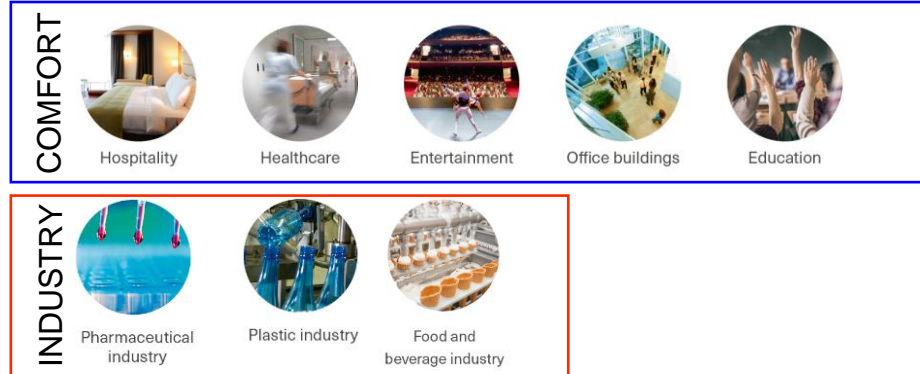

SELLING POINTS

- **Compact:** All models only 78 cm depth up to 50 size, then 103 cm
- Ideal for plant with **future expansion** thanks to FlexMaster controller
- **Competitive price** Vs. inverter solutions
- **SEER** up to 4.22
- **SCOP** up to 3.93





TRANE®